

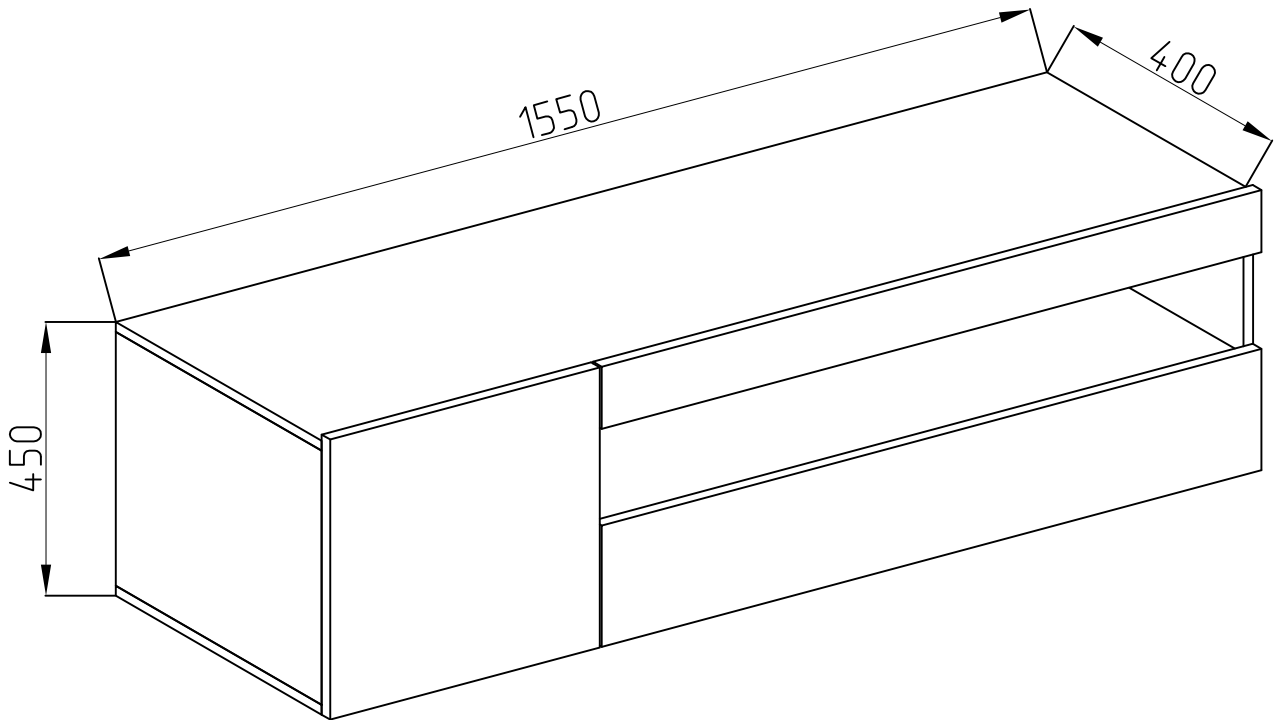

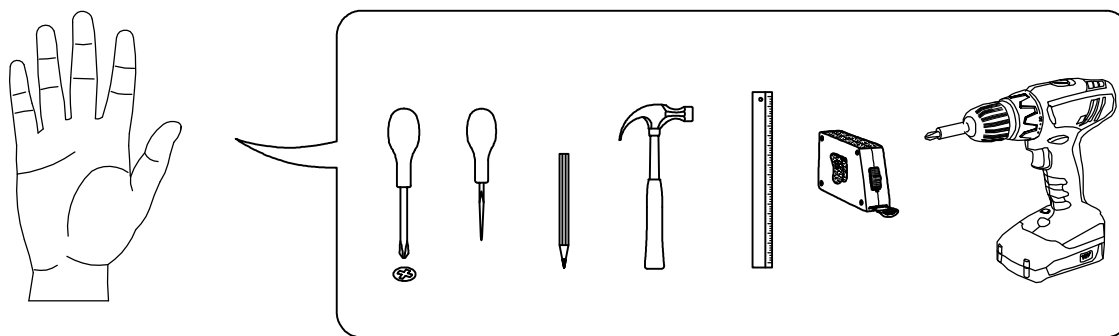

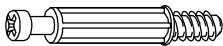



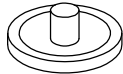

Lorenzo 1

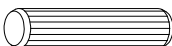
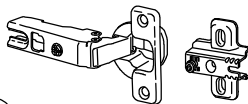

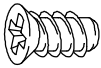
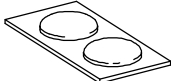

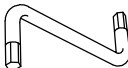
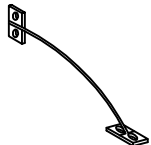

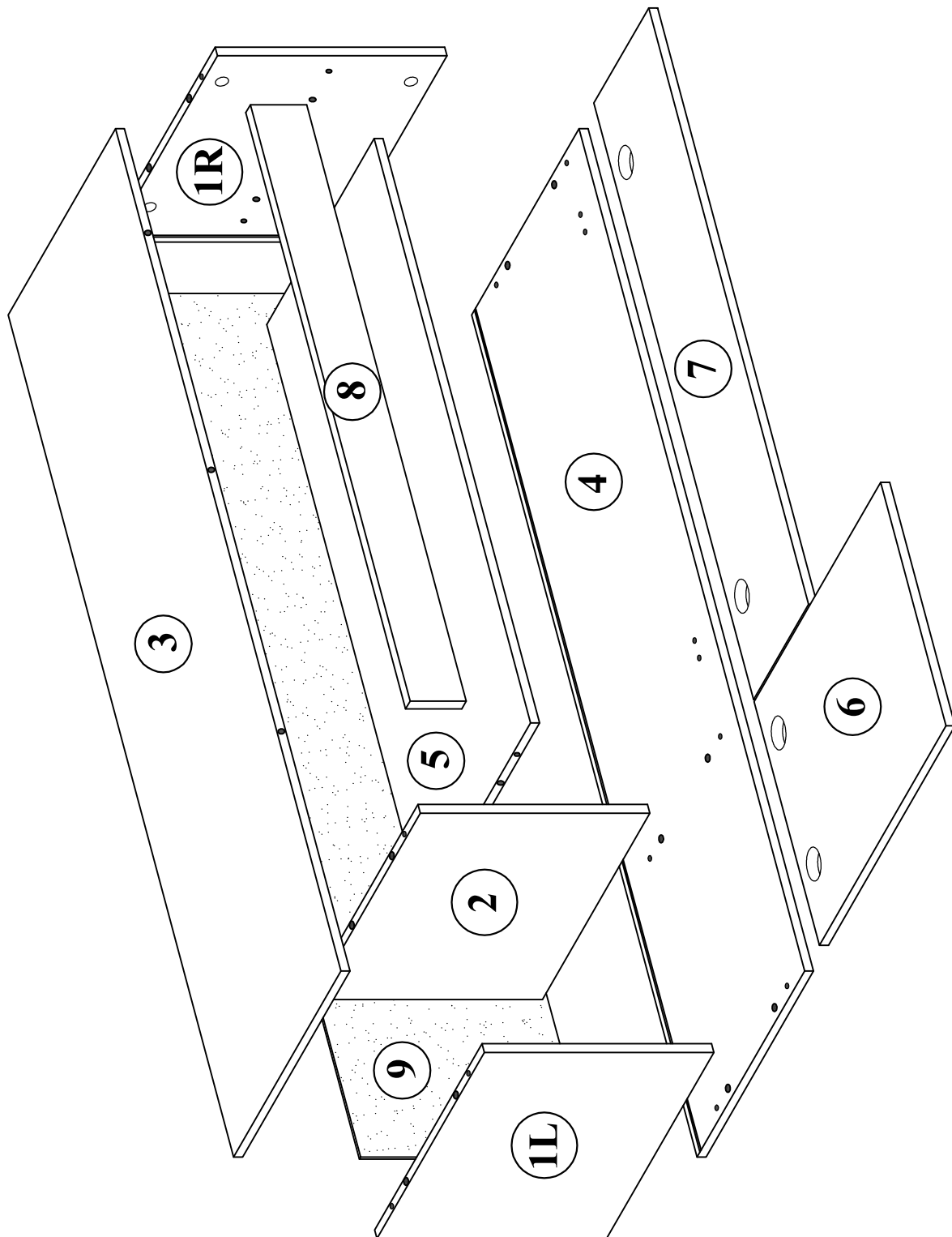

 C1 6*43mm x19	 D1 15/16 x19	 D ϕ 20mm x19
 K5 x6	 A1 8*30mm x16	 L1 x4
 E10 4*16mm x8	 F2 6,3*13mm x8	 U6 x4
 H2 x8	 R4 N°4 x1	 S8 x2
 E2 3*15mm x8		

No	a*b	x
1	408x382	2
2	408x368	1
3	1549x382	1
4	1549x382	1
5	1075x368	1
6	450x448	1
7	195x1097	1
8	100x1097	1
9	1524x417	1

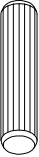

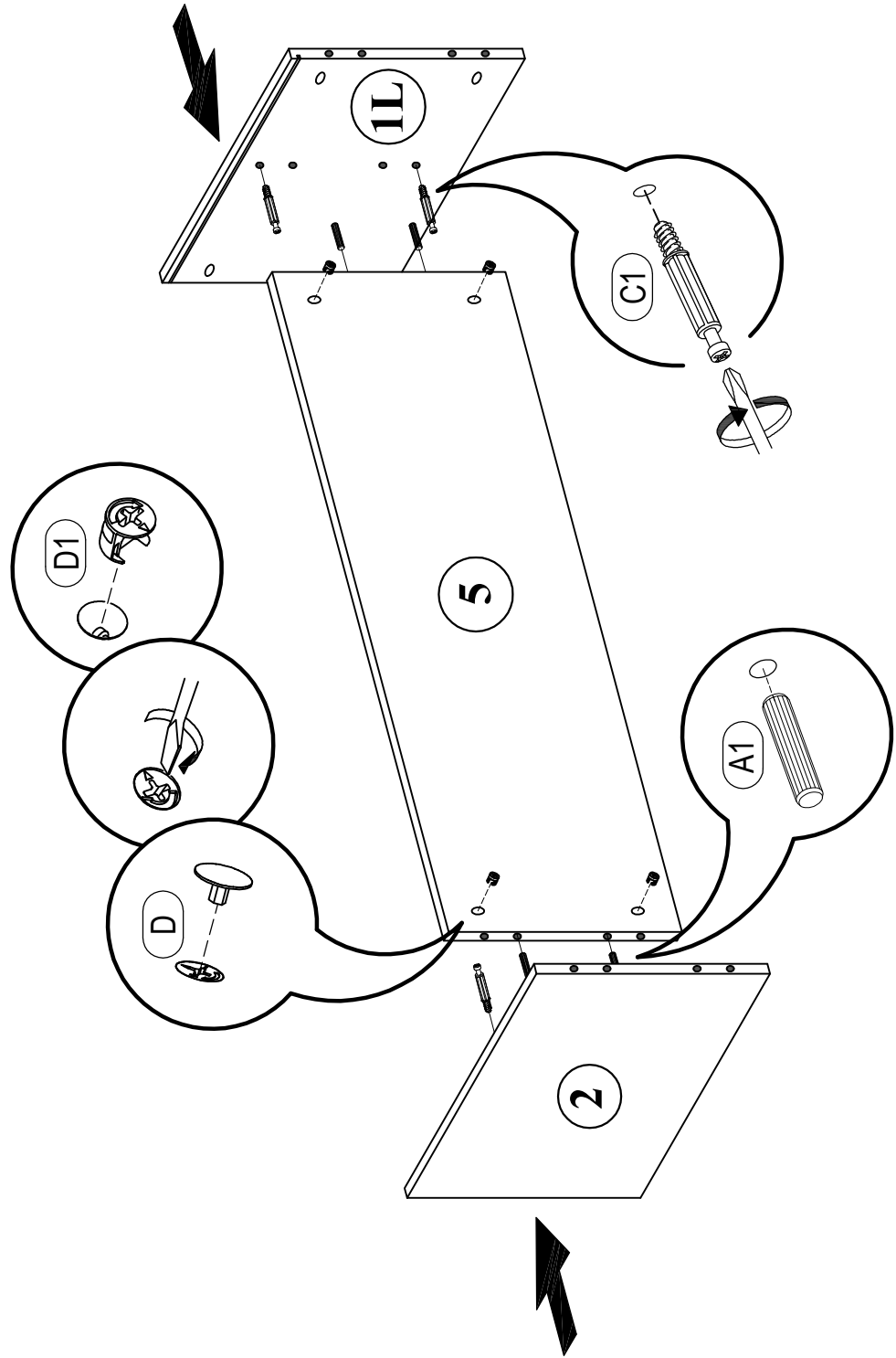

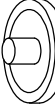
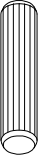

 C1 6*43mm x4	 D1 15/16 x4	 D ϕ 20mm x4	 A1 8*30mm x4
---	--	---	---

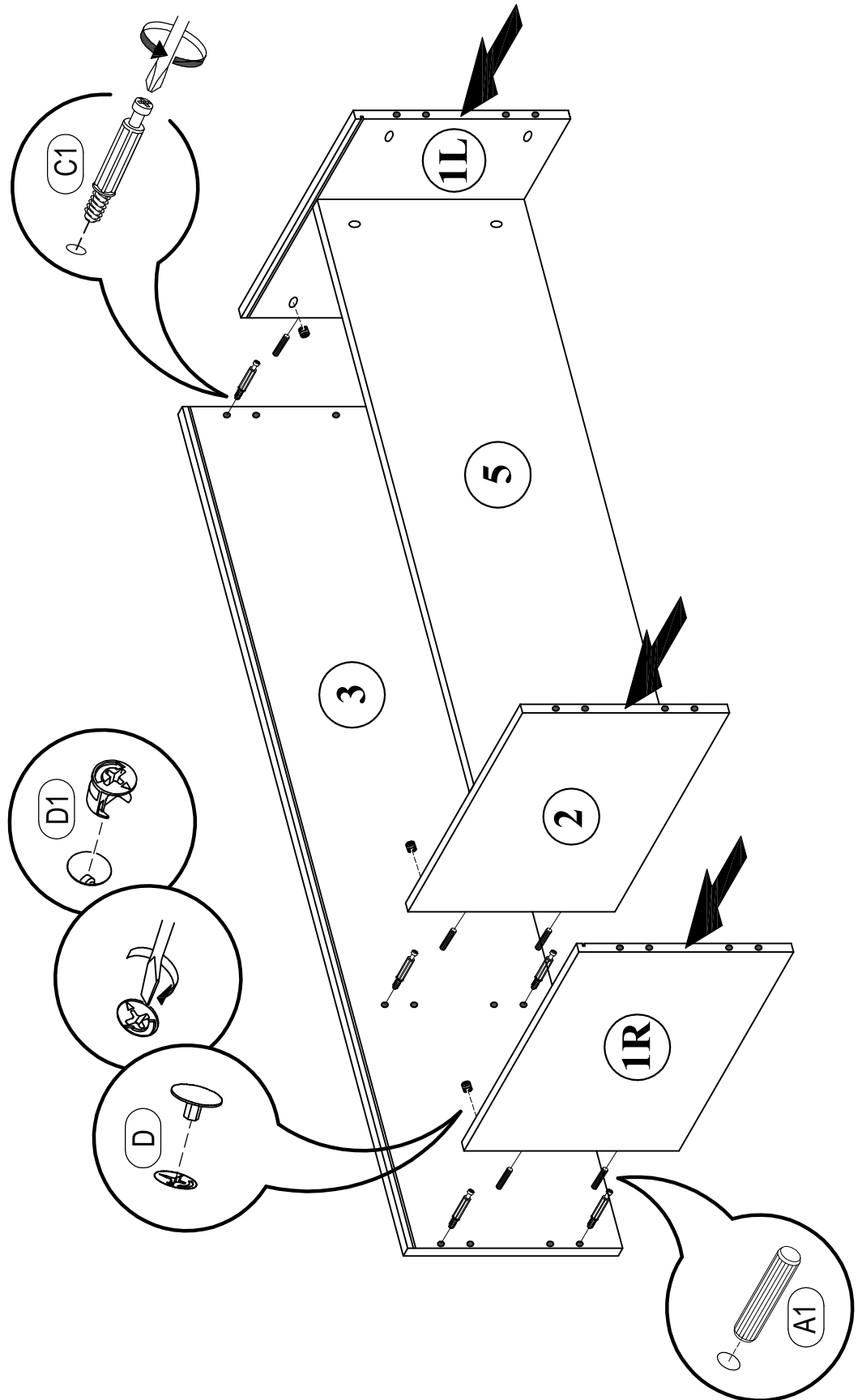

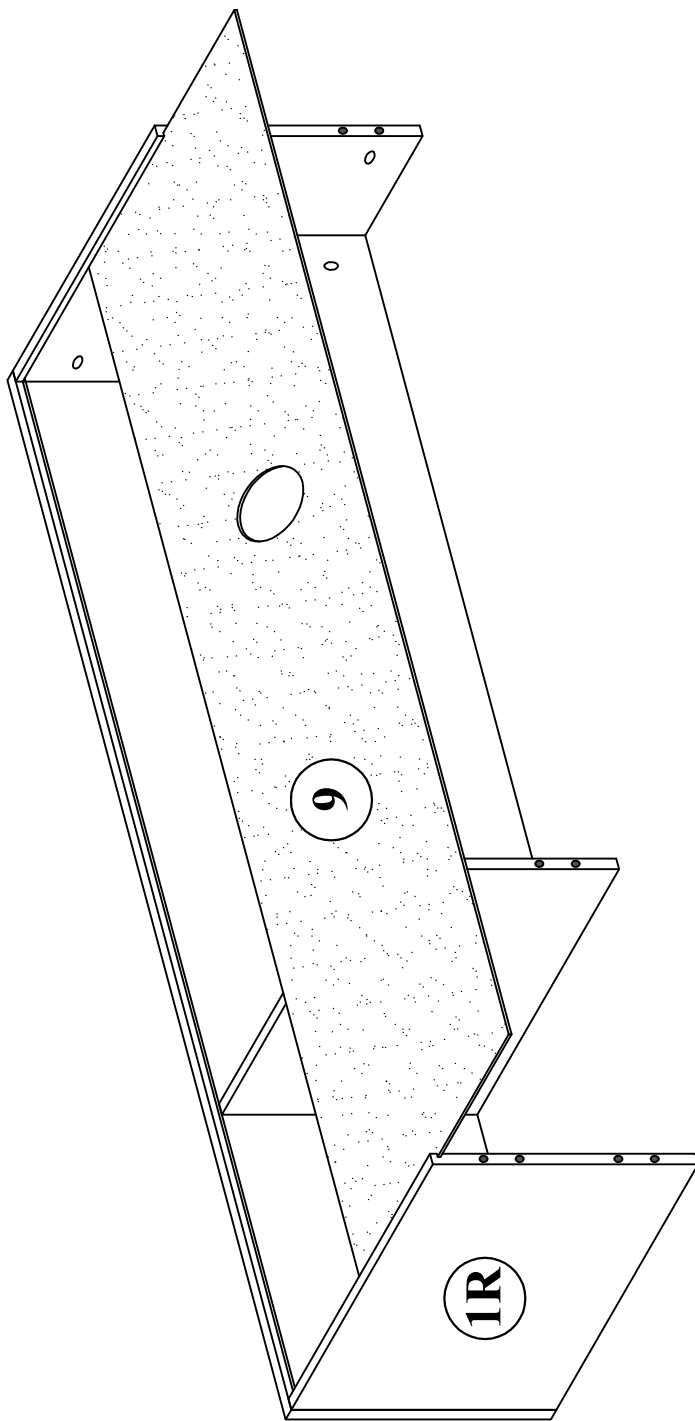



 C1	6*43mm	x6	 D1	15/16	x6	 D	φ20mm	x6	 A1	8*30mm	x6
---	--------	----	---	-------	----	--	-------	----	---	--------	----

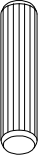

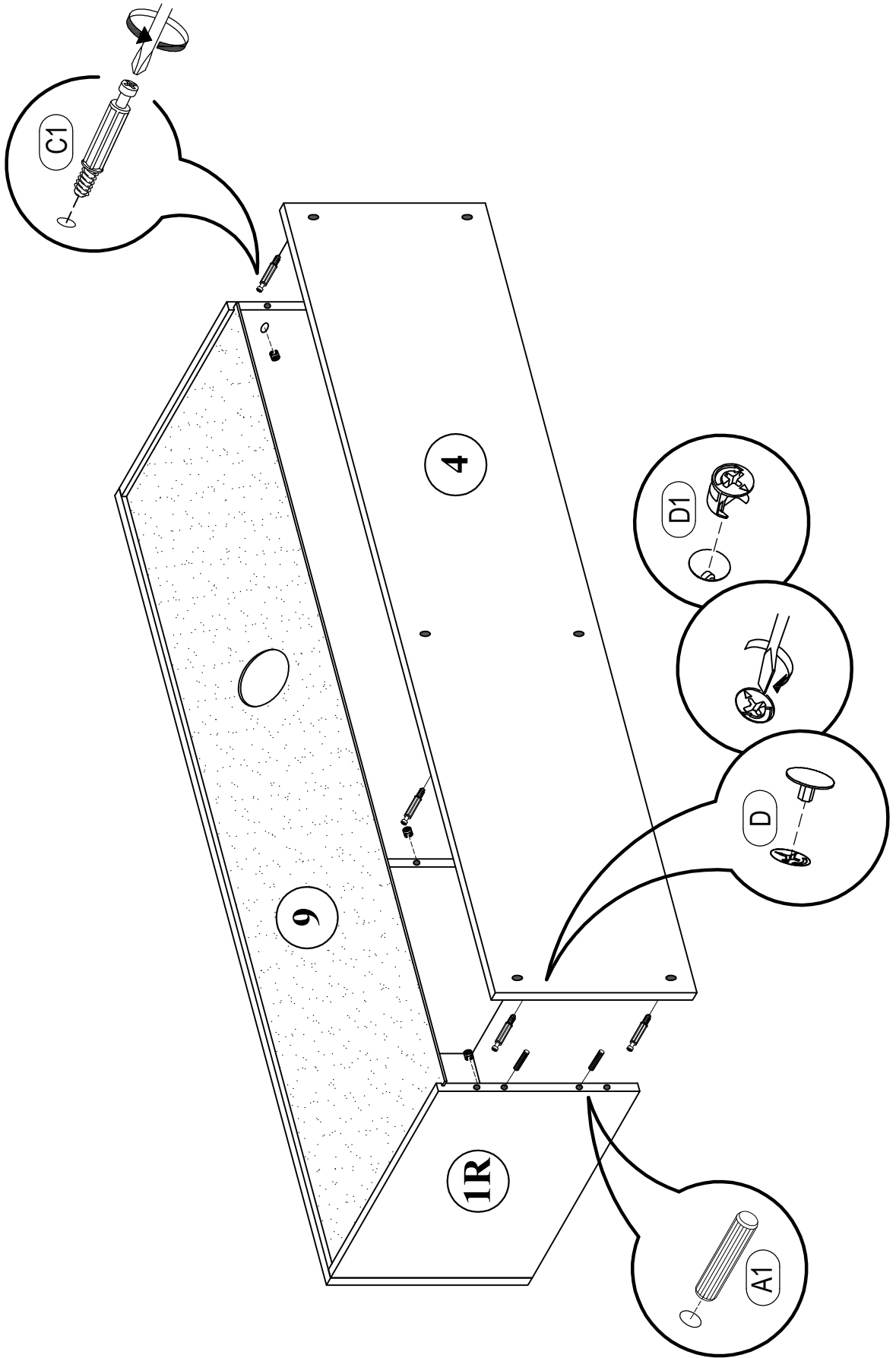





	C1	6*43mm	x6
	D1	15/16	x6
	D	φ20mm	x6
	A1	8*30mm	x6

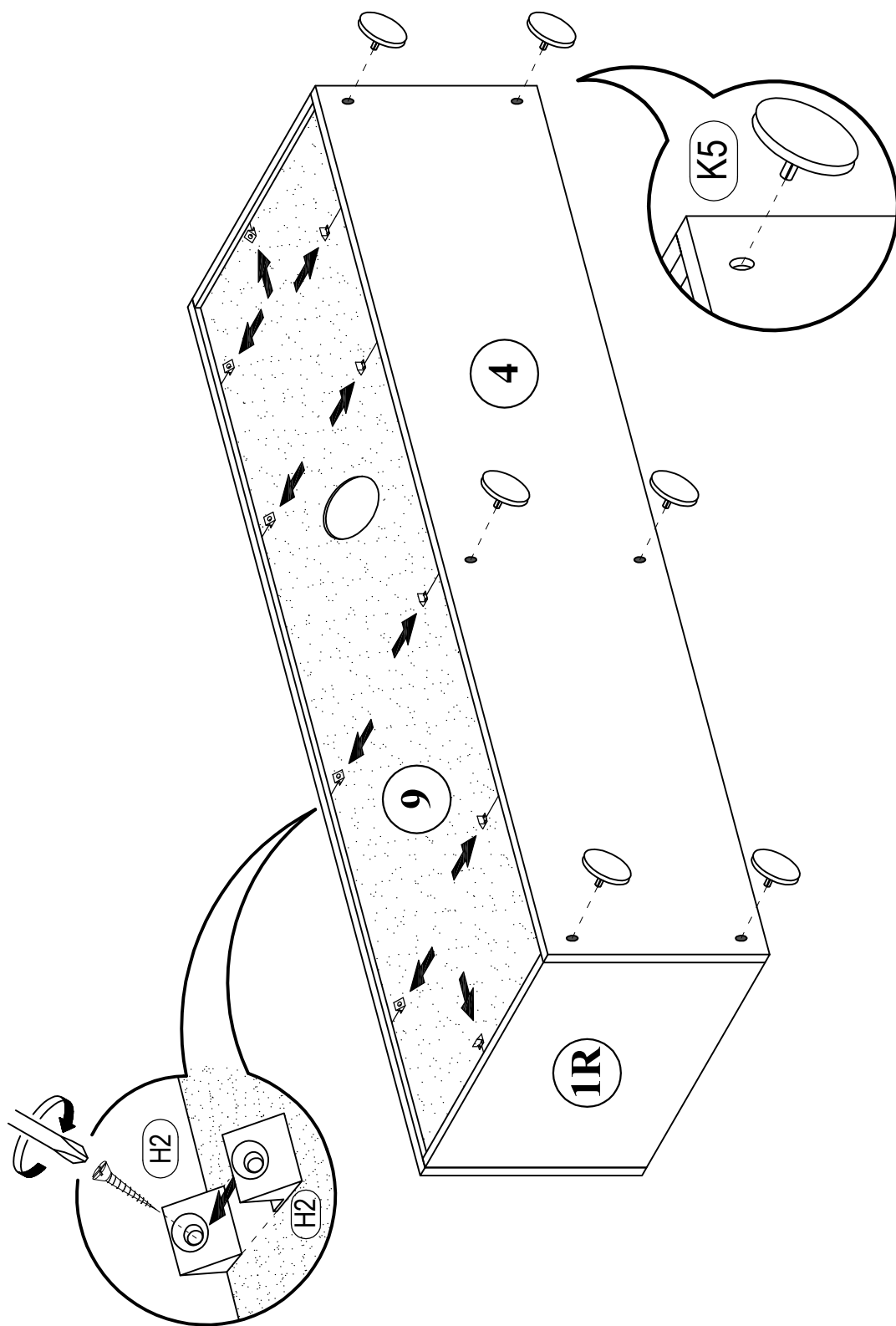

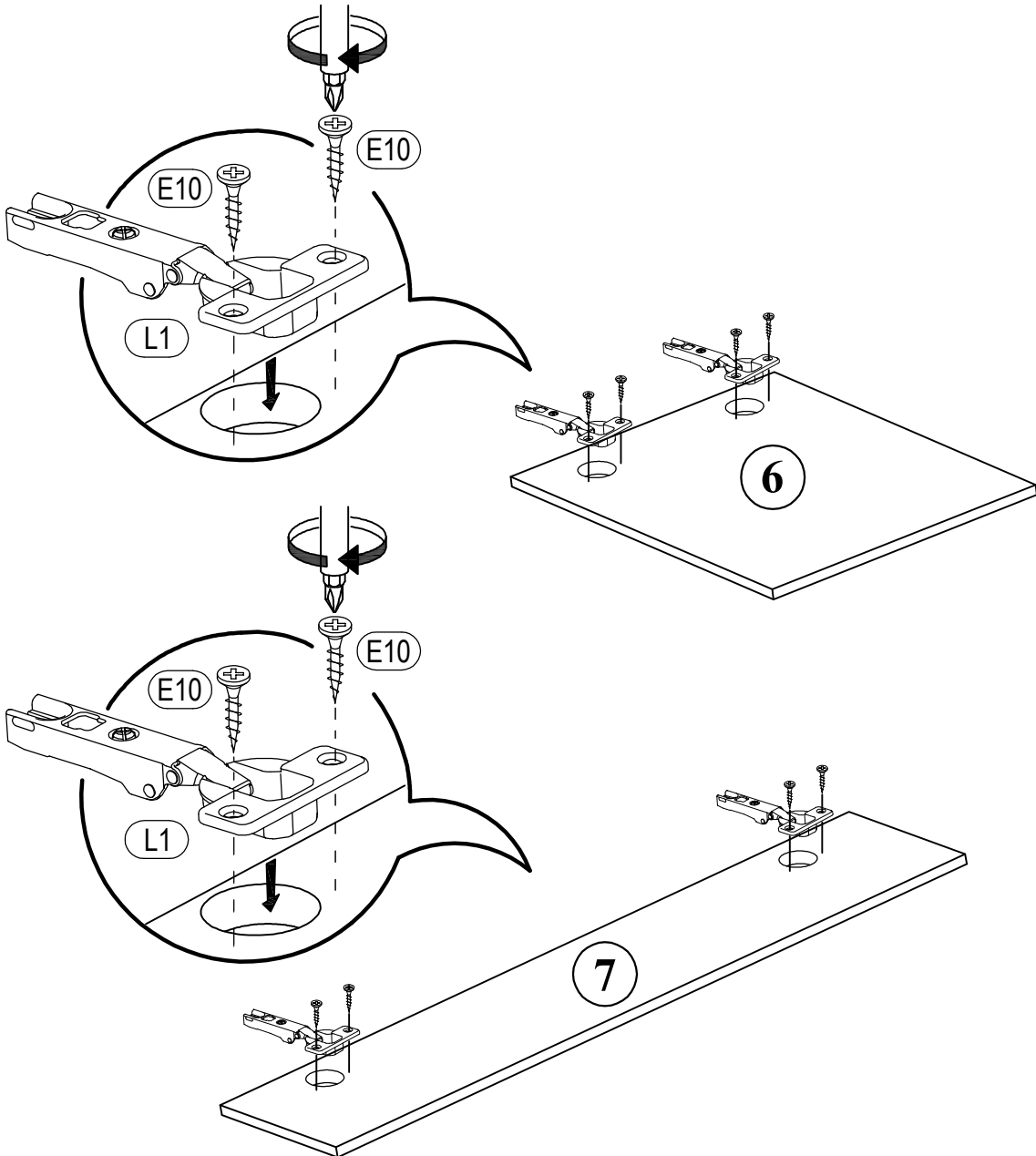

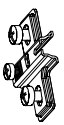
 (K5)	 x6	 (H2)	 x10
--	--	--	---

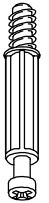

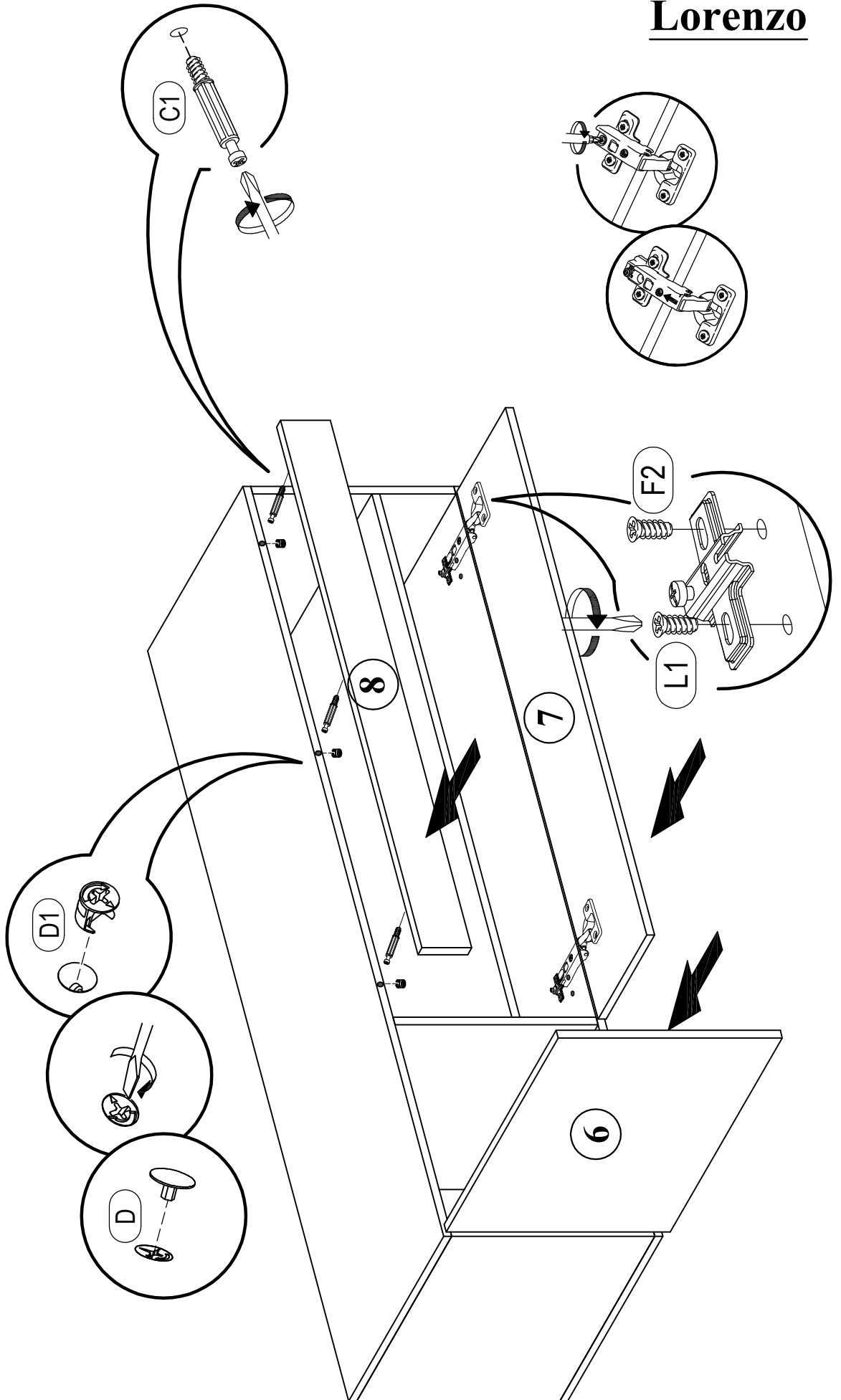

	x4			6,3*13mm x8		6*4,3mm x3		15/16 x3		ø20mm x3
---	----	---	---	-------------	---	------------	---	----------	---	----------

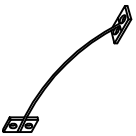
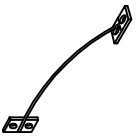

		3 * 15mm	x8
		x2	
