

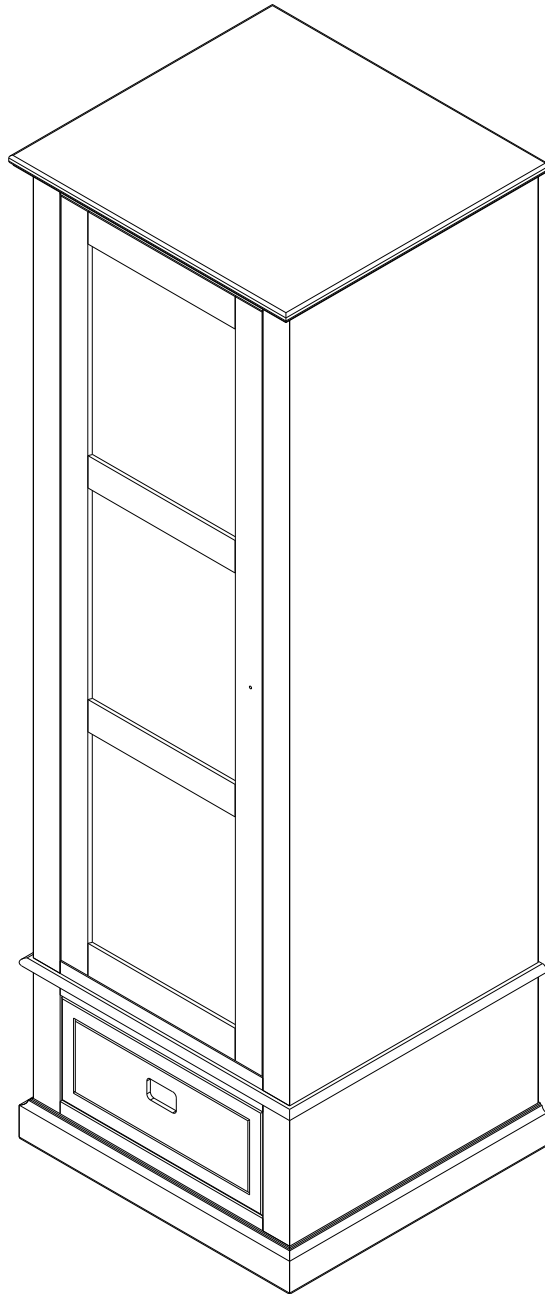

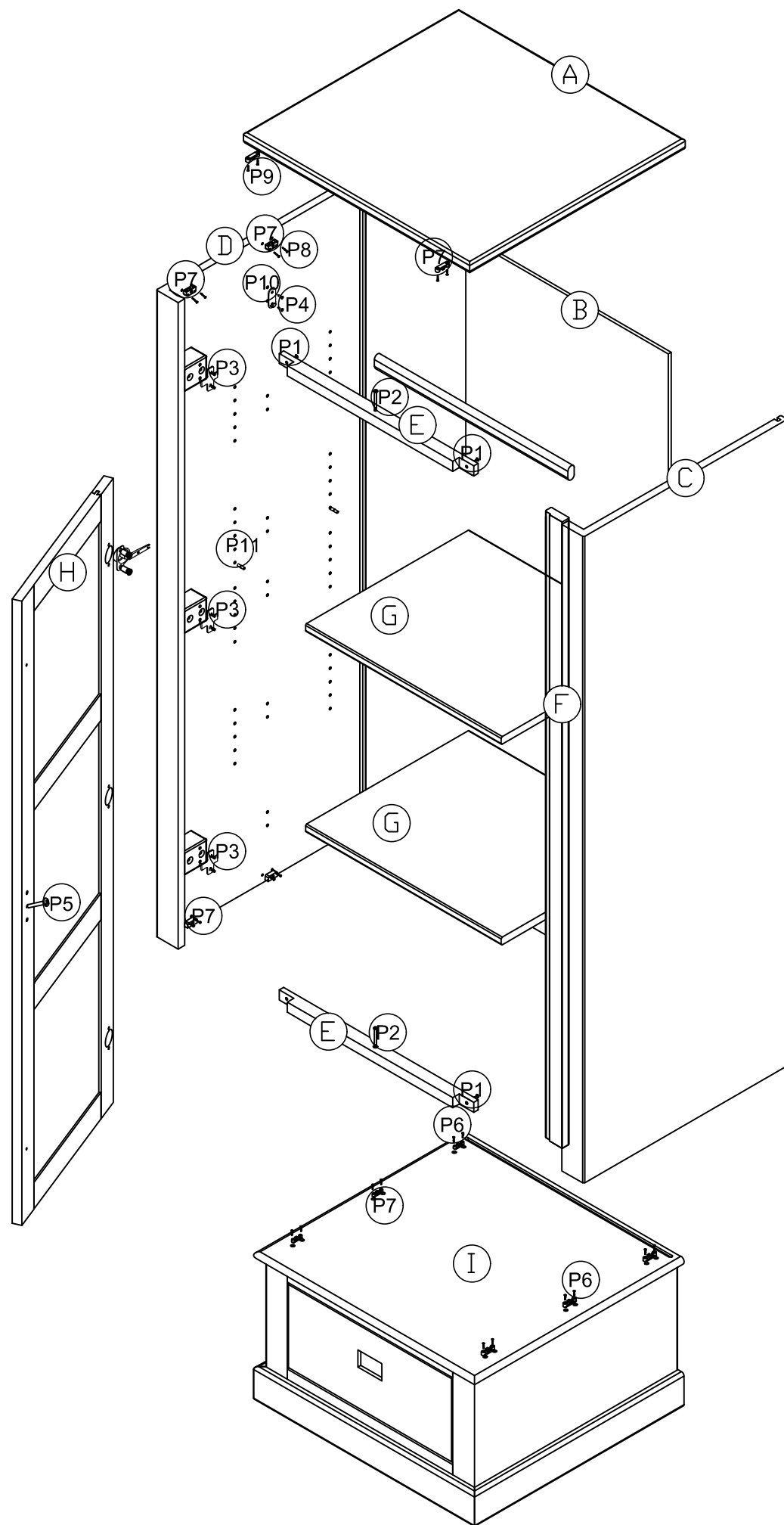





# *BREACH - Cabinet 1V+1L*

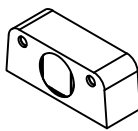
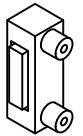
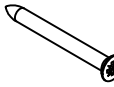
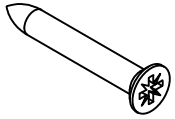
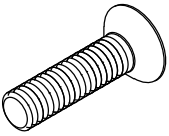

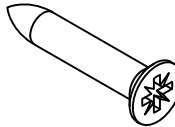
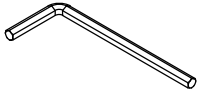
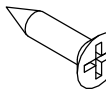
MONTAGEANLEITUNG  
ASSEMBLY INSTRUCTIONS  
NAVODILA ZA MONTAŽO

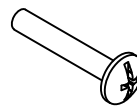

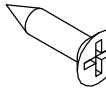
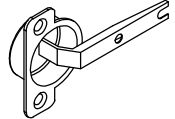
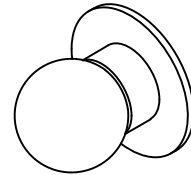
		
P1, 4x25	P7,	P14, door magnet/ Türmagnet
piece/Stück	4	piece/Stück
		
P2, 4x40	P8, 3,5x25	P16, M6x20.
piece/Stück	2	piece/Stück
		
P3, euro screw/Euroschraube 6,3 x 13	P9, 3,5x20	P17 Hexagon socket screw key4mm/ /Steckschlüsse 4mm
piece/Stück	12	piece/Stück
		
P4, speck screw 3 x 16	P10, carrier/Träger	
Spanplattenschraube 3 x 16	piece/Stück	2
piece/Stück	8	
		
P5, piece/Stück	P11, bracket/Träger ø5x16	A the closet roof/das schrankdach
1	piece/Stück	8
		B the back of the closet/die Rückseite des Schrankes
P6, 3,5 x 16	P12, hinges/Scharniere	C side panel/Seitenleiste
piece/Stück	piece/Stück	D side panel/Seitenleiste
12	3	E batten/Latte
		F magnet carrier/Magnetträger
P13, handle/Griff		G shelf/Regal
piece/Stück	1	H door/Türen
		I the lower part of the closet/der untere Teil des Schrankes

