

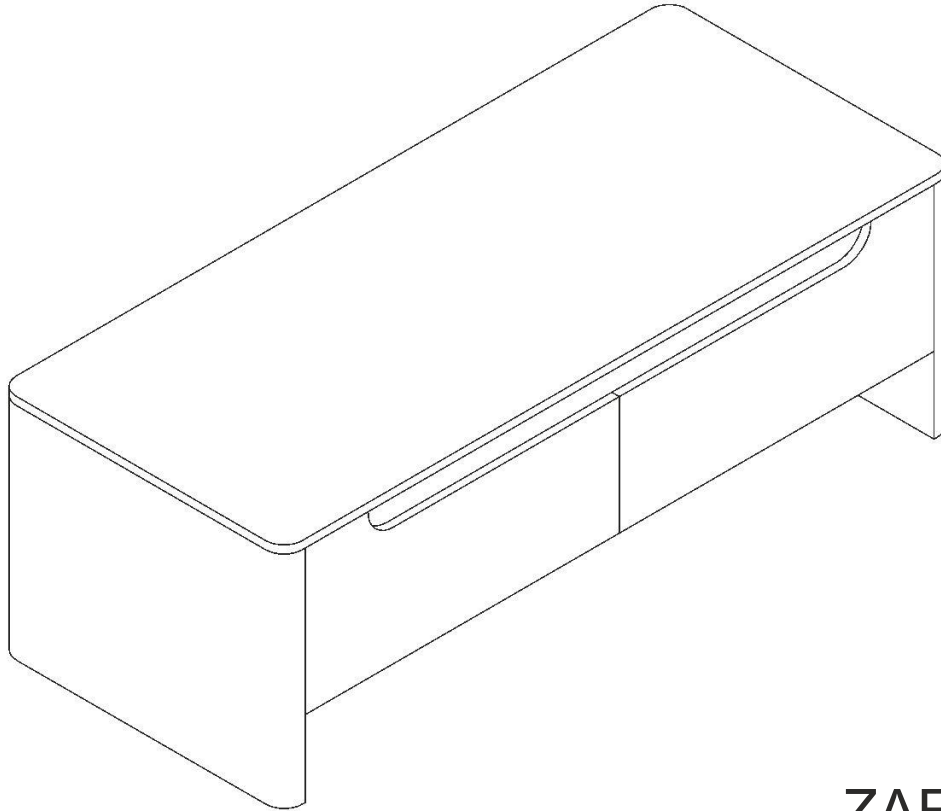









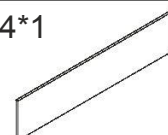
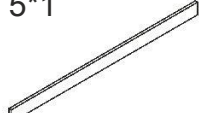

NAVODILA ZA SESTAVO/ASSEMBLY INSTRUCTIONS/AUFBAUANLEITUNG

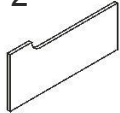

ZARAGOZA

1*1 	2*1 	3*1 	4*1 	5*1 
6*2 	7*4 	8*2 	9*2 	10*2 
A*26 	B*12 	C*2 	D*16 	E*8 