

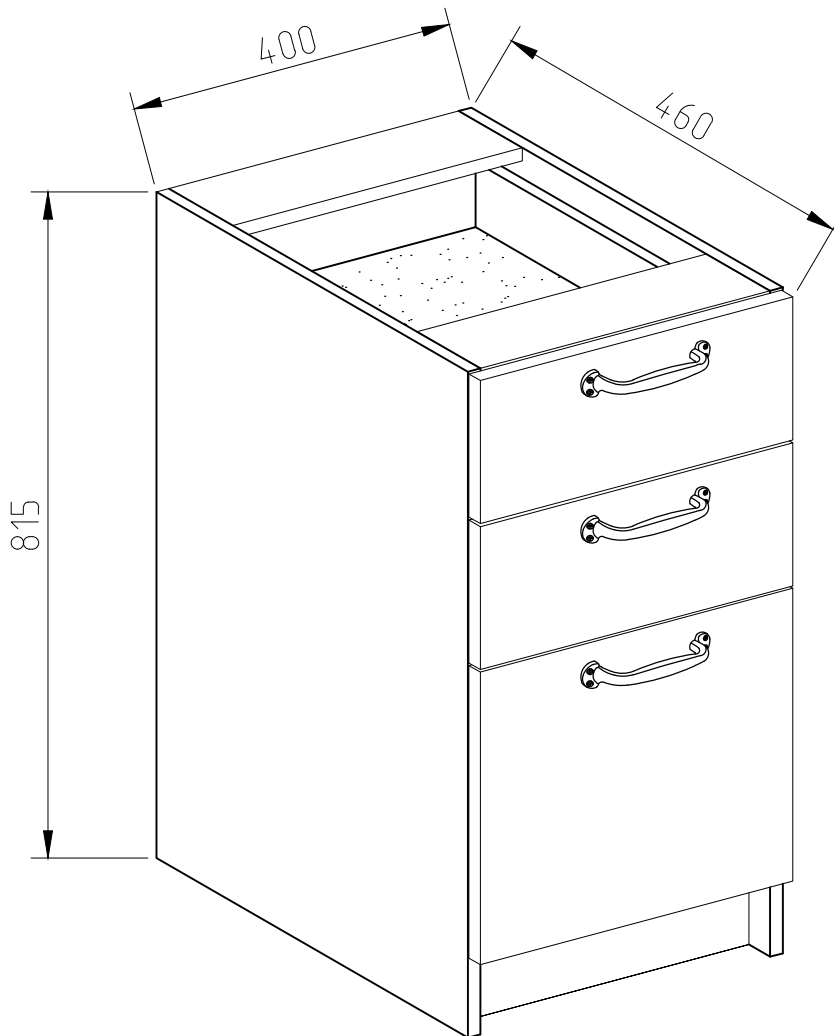

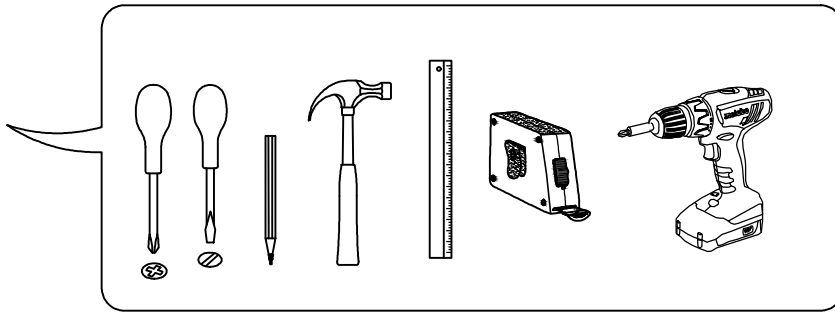

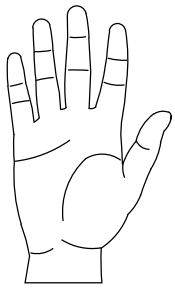





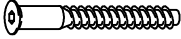

# PARIGOT

## D 40 D

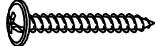

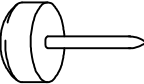

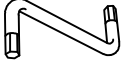
 (A1) 8*30mm x30	 (B) $\phi$ 12mm x18	 (B1) 6,3*50mm x18
 (C1) 6*43mm x8	 (D) $\phi$ 20mm x8	 (D1) 15/16 x8
 (E2) 3*13mm x24	 (E10) 4*30mm x4	 (Ea1) 3,5*27mm x6
 (I37) x3	 (K1) x4	 (M1) 400mm x3
 (R3) 1.4*25mm 0.01kg	 (R4) N°4 x1	

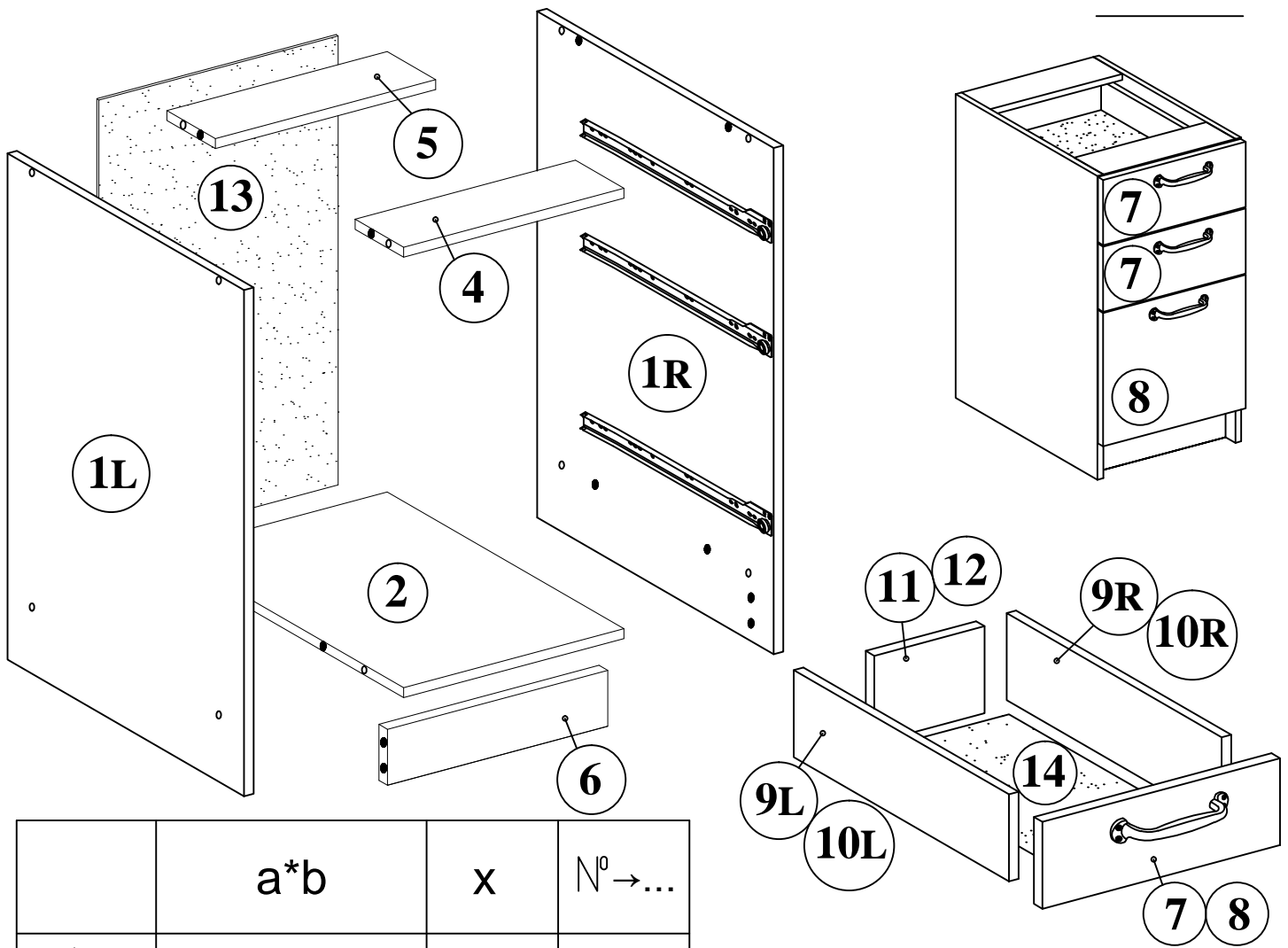

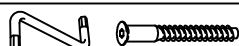

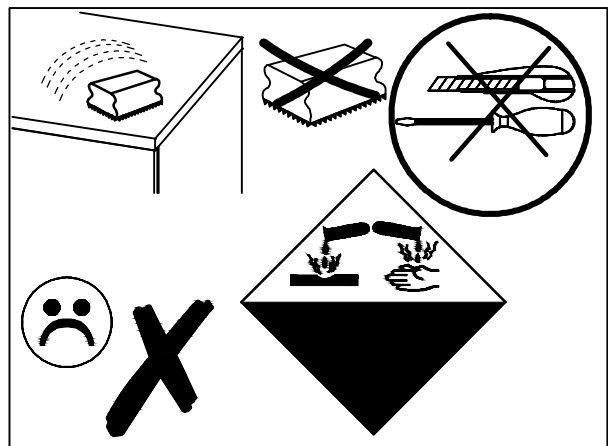
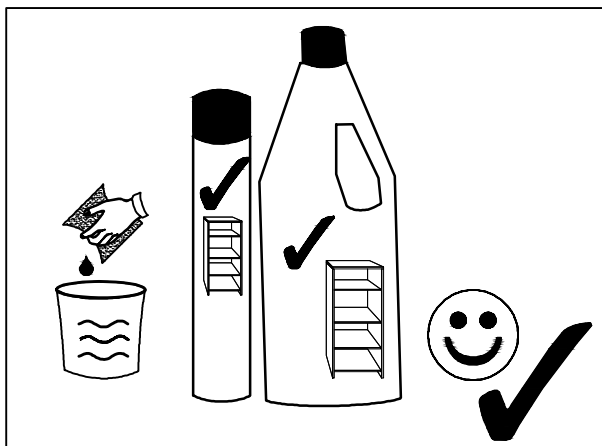
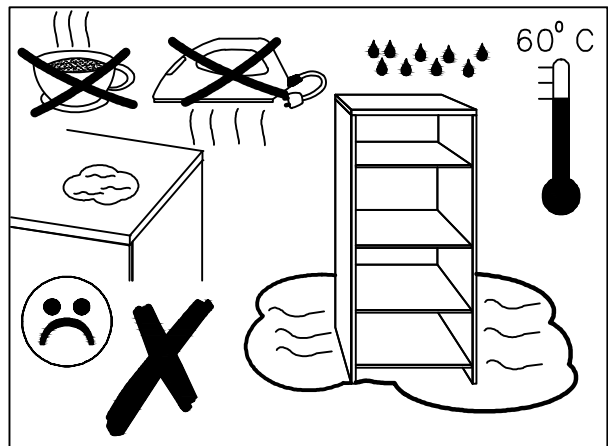
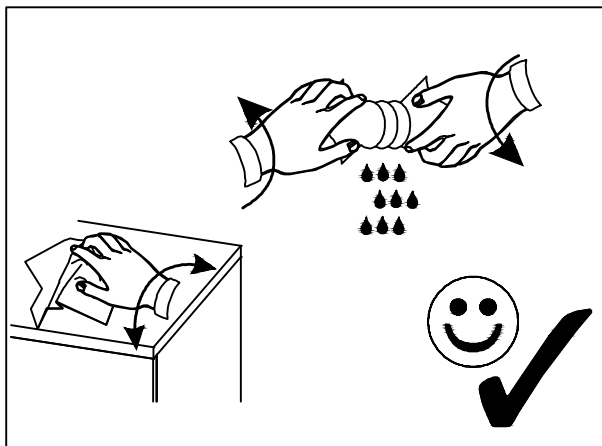
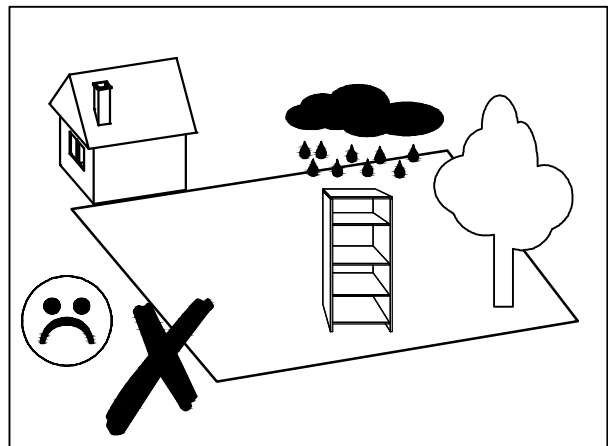
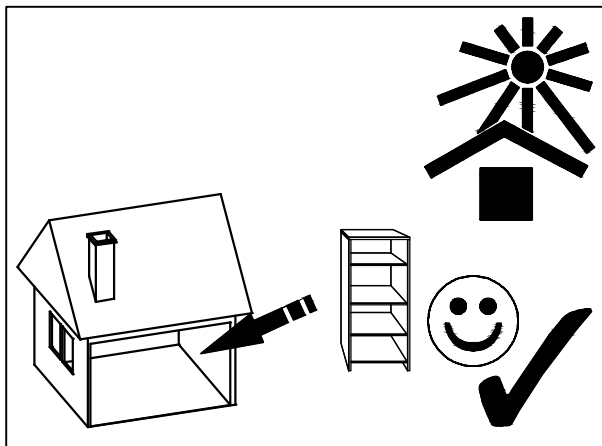
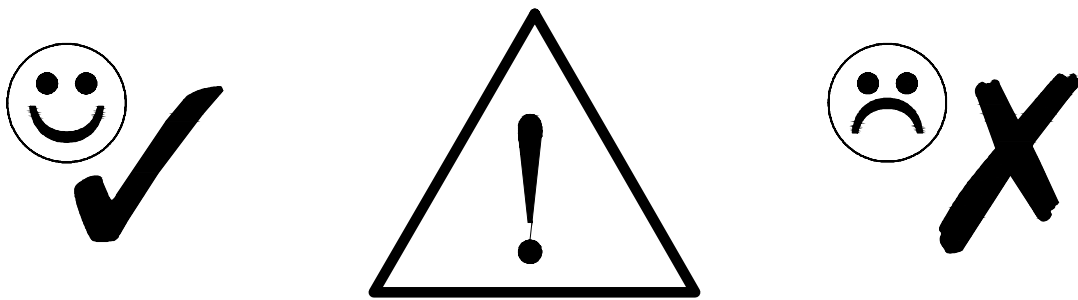

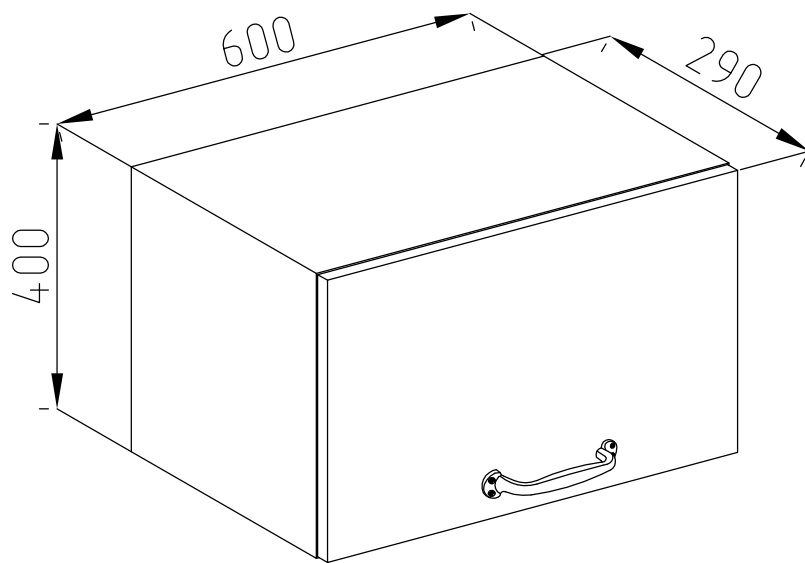

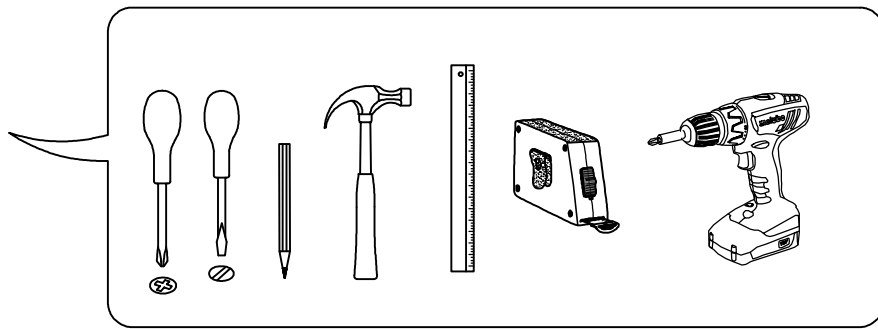
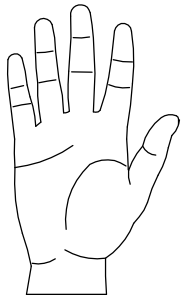
	a*b	x	N° → ...
1L	815x440	x1	
1R	815x440	x1	
2	367x440	x1	
4	367x90	x1	
5	367x90	x1	
6	367x90	x1	
7	175x396	x2	
8	358x396	x1	
9L	400x120	x2	
9R	400x120	x2	
10L	400x200	x1	
10R	400x200	x1	
11	309x120	x2	
12	309x200	x1	
13	396x723	x1	
14	318x393	x3	
		x1	

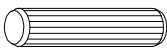



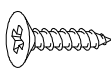
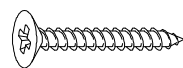
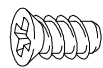

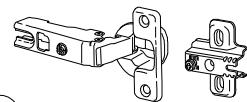
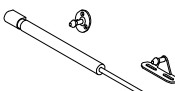
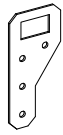
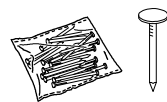
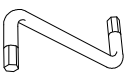
 <b>A1</b> 8*30mm x10	 <b>B</b> $\phi$ 12mm x8	 <b>B1</b> 6,3*50mm x8
 <b>E6</b> 3,5*16 x10	 <b>E9</b> 4*16mm x4	 <b>E10</b> 4*30mm x10
 <b>F2</b> 6,3*13mm x4	 <b>I37</b> x1	 <b>L1</b> x2
 <b>N3</b> N40 x2	 <b>O5</b> x2	 <b>R3</b> 1.4*25mm 0.01kg
 <b>R4</b> N°4 x1		

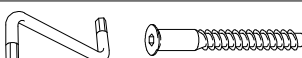
No	a*b	x	N° → ...
1	400x270	x2	
2	567x270	x1	
2a	567x270	x1	
3	388x596	x1	
4	396x596	x1	
		x1	

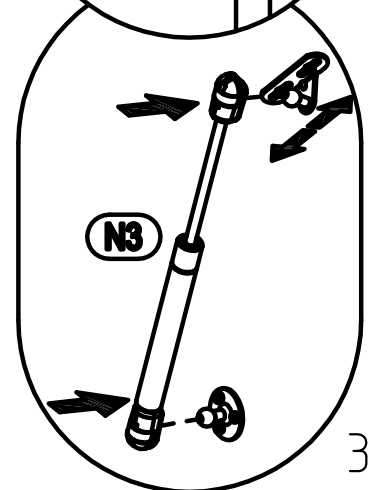
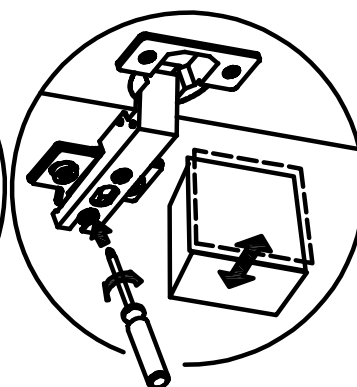
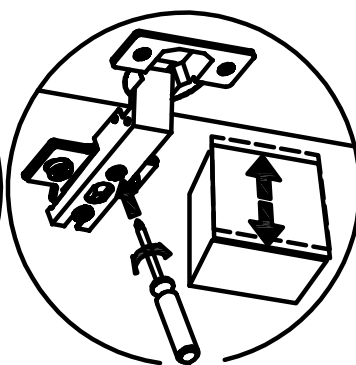
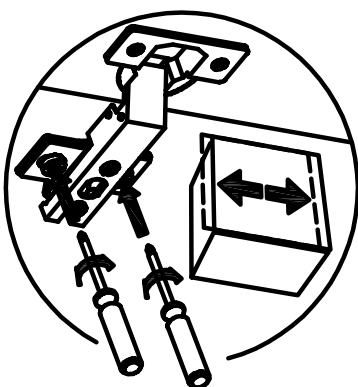
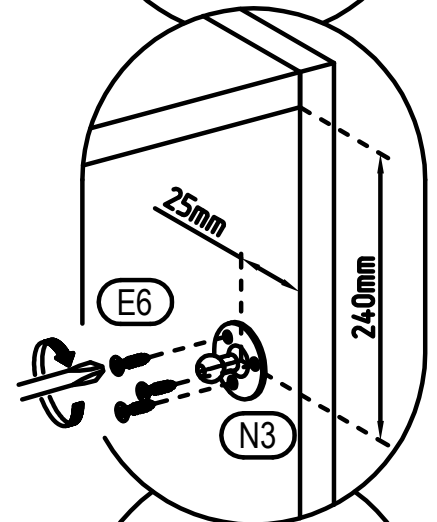
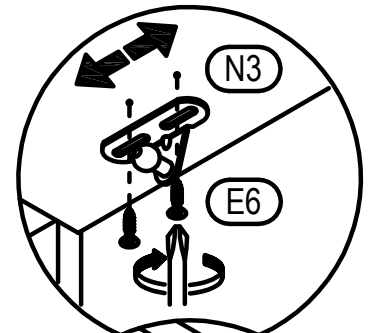
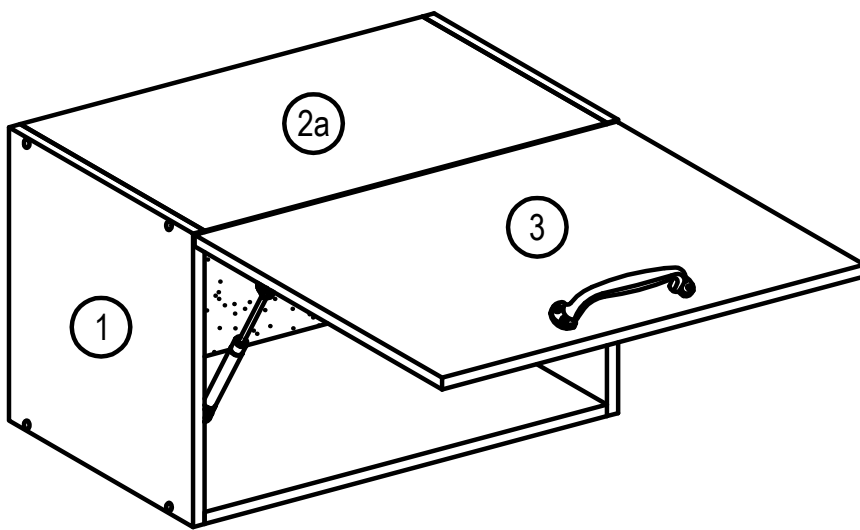
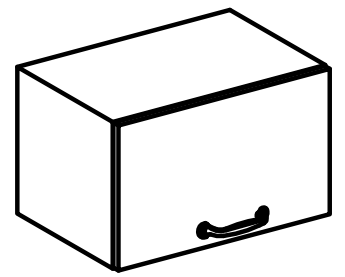
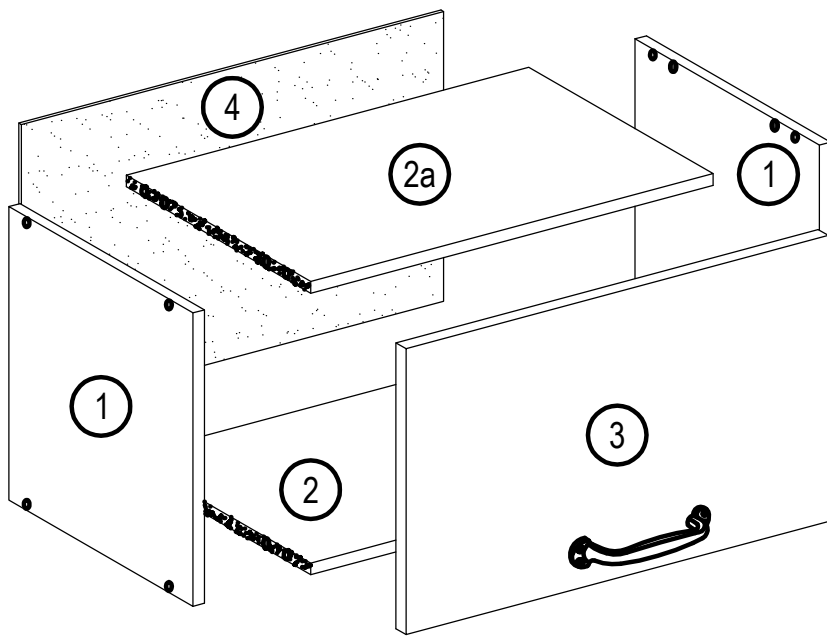

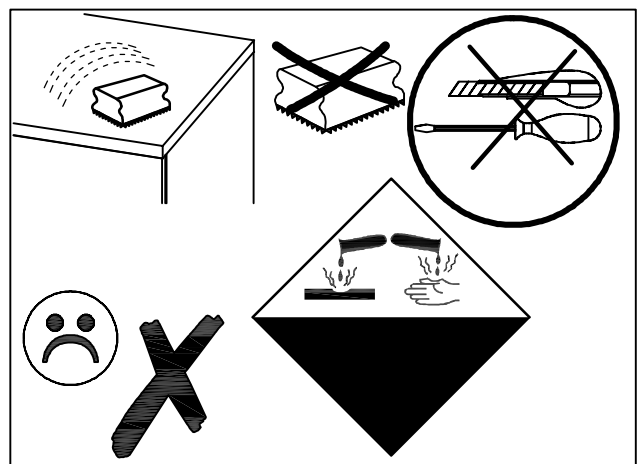
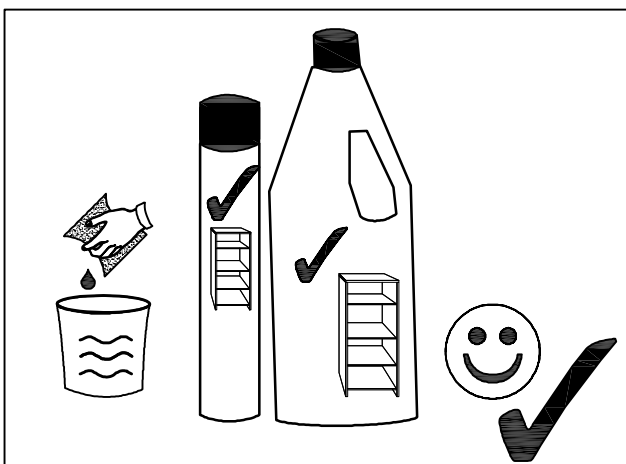
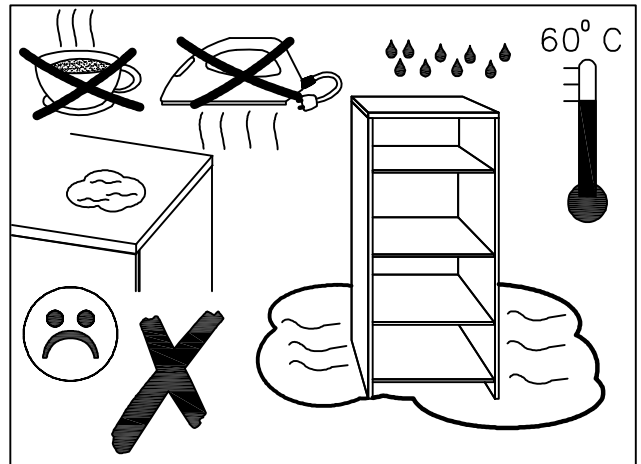
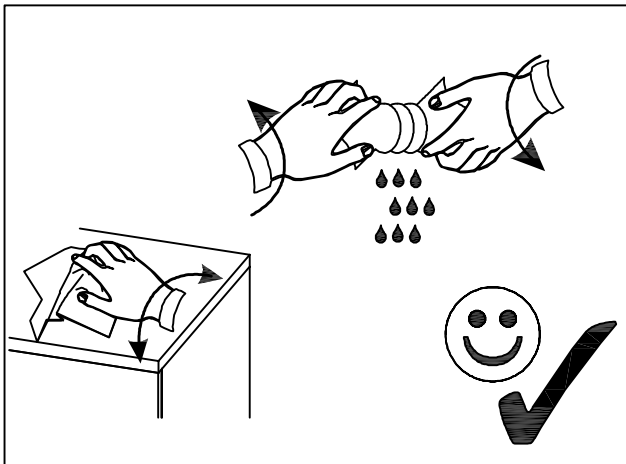
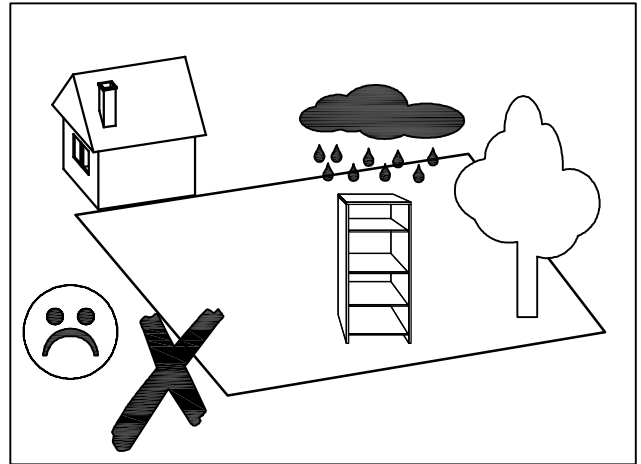
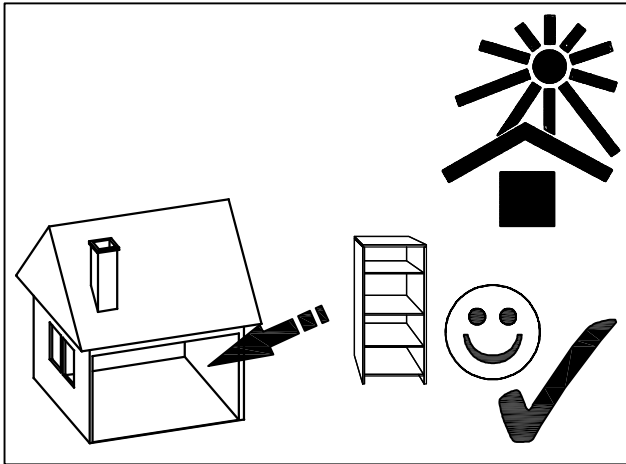
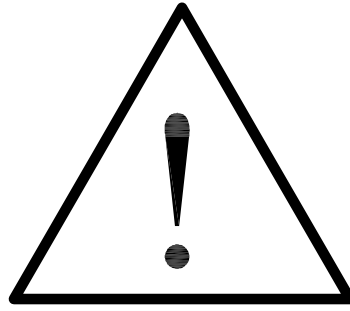







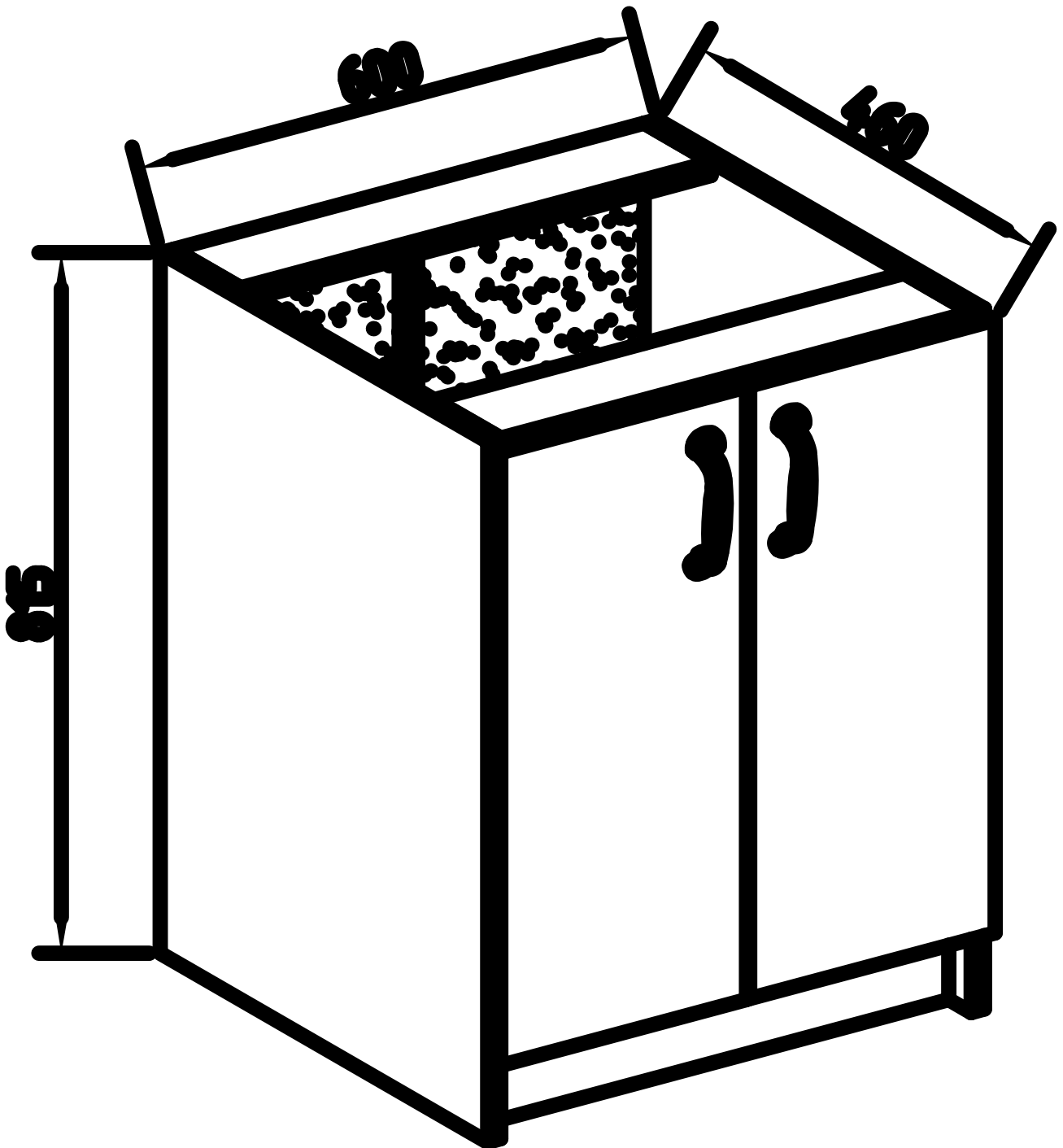

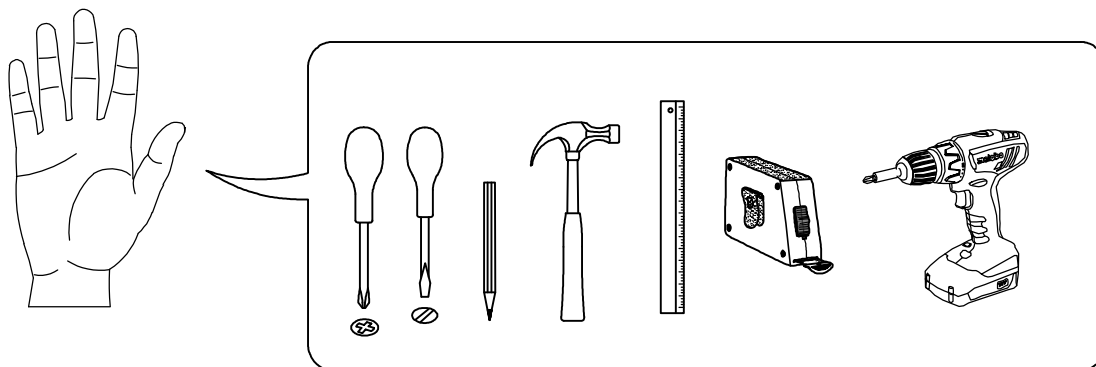

---

**D 60**

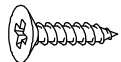
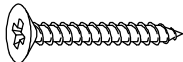
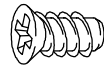

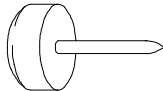
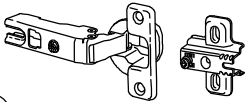

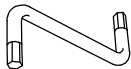
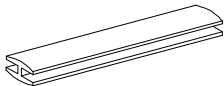
 <b>(A1)</b> 8*30mm x10	 <b>(B)</b> $\phi$ 12mm x10	 <b>(B1)</b> 6,3*50mm x10
 <b>(E9)</b> 4*16mm x8	 <b>(E10)</b> 4*30mm x4	 <b>(F2)</b> 6,3*13mm x8
 <b>(I37)</b> x2	 <b>(J1)</b> x4	 <b>(K1)</b> x4
 <b>(L1)</b> x4	 <b>(R3)</b> 1.4*25mm 0.01kg	 <b>(R4)</b> N°4 x1
 <b>(P10)</b> L-685mm x1		

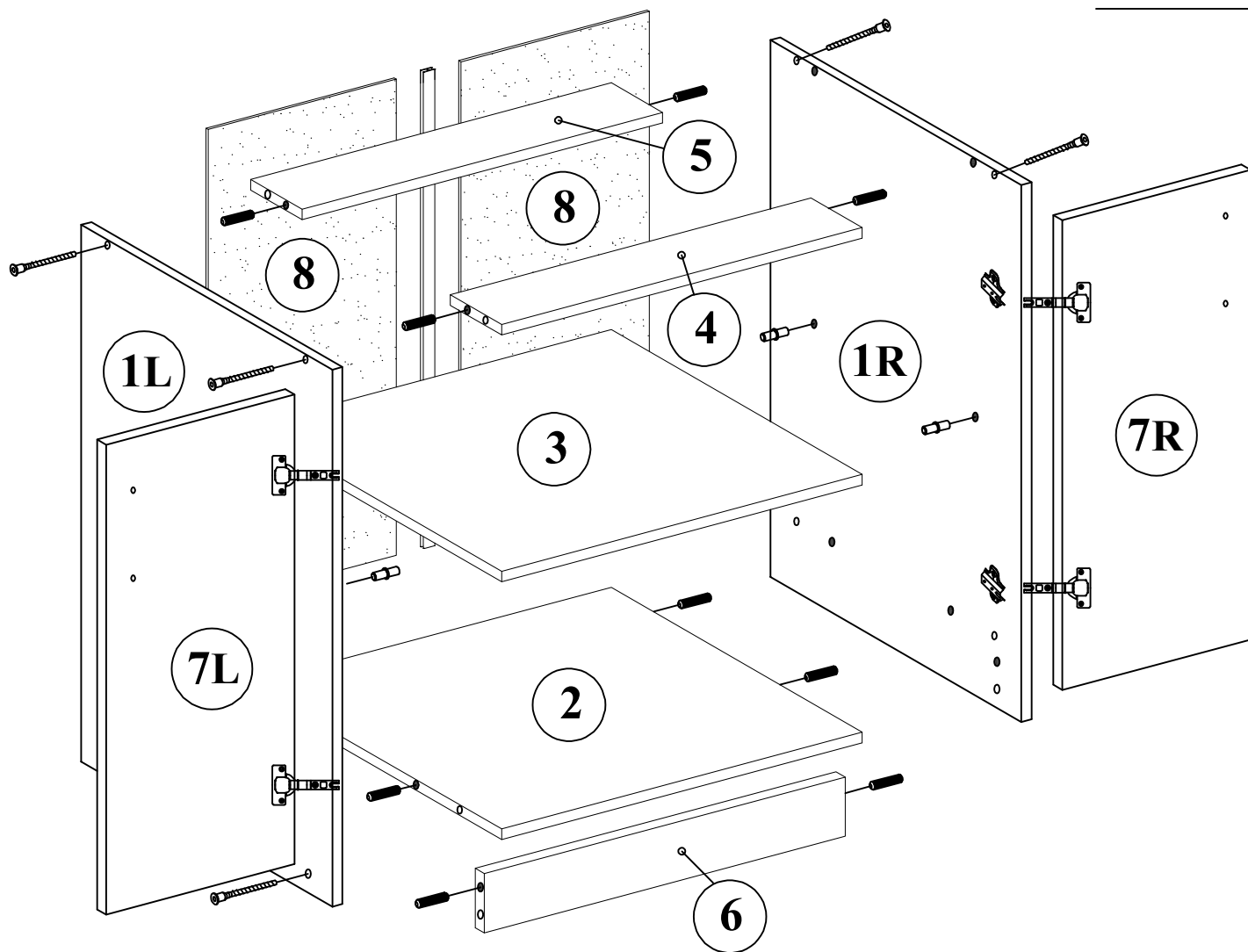

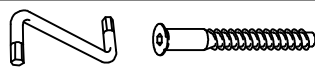
No	a*b	x	N° → ...
1L	815x440	x1	
1R	815x440	x1	
2	567x440	x1	
3	567x420	x1	
4	567x90	x1	
5	567x90	x1	
6	567x90	x1	
7L	713x296	x1	
7R	713x296	x1	
8	723x296	x2	
		x1	

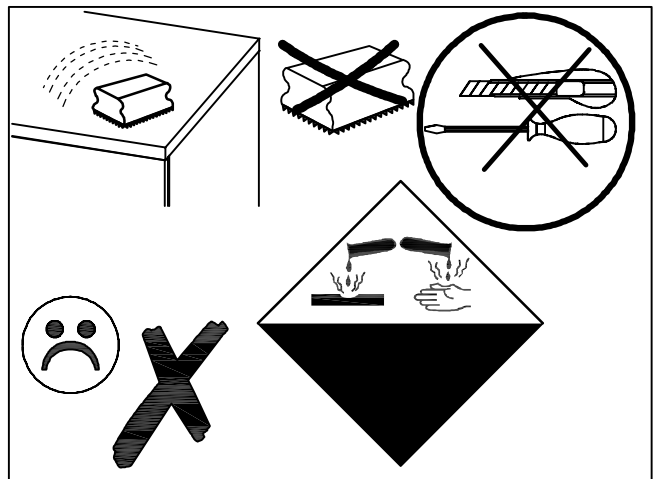
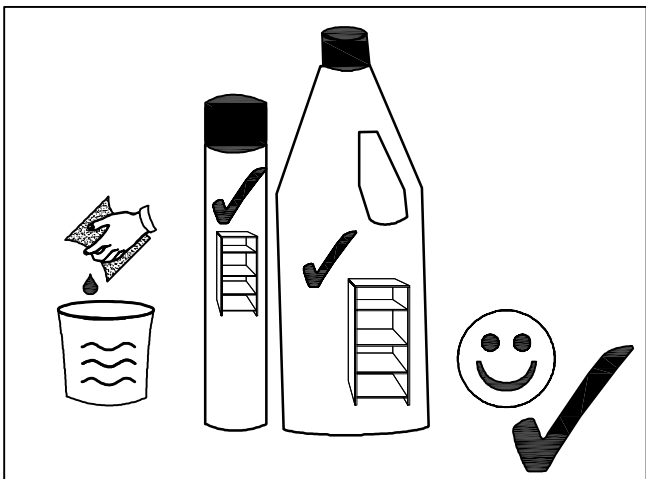
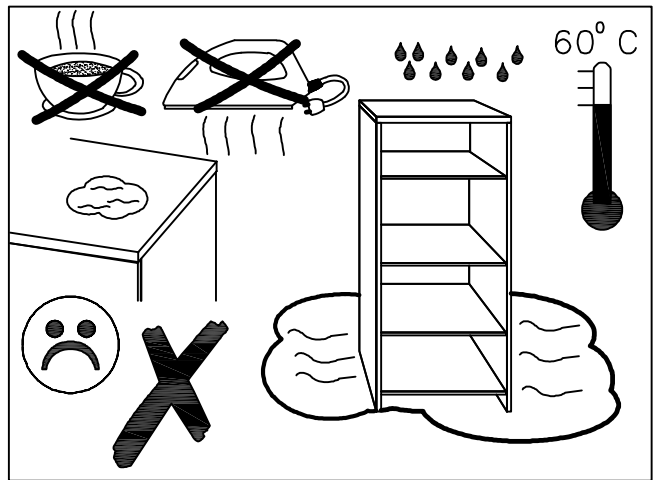
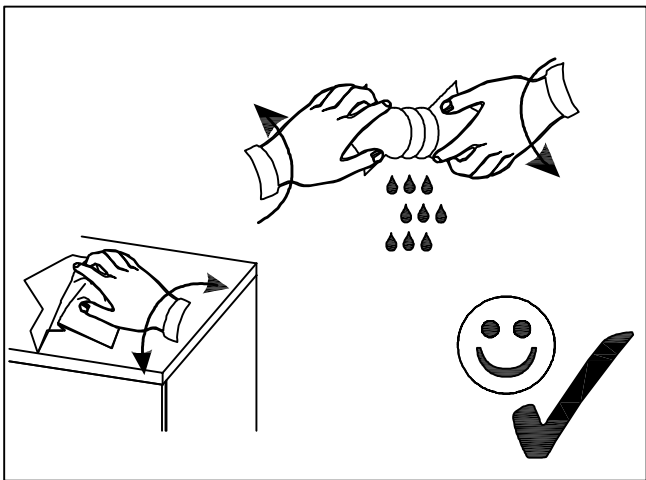
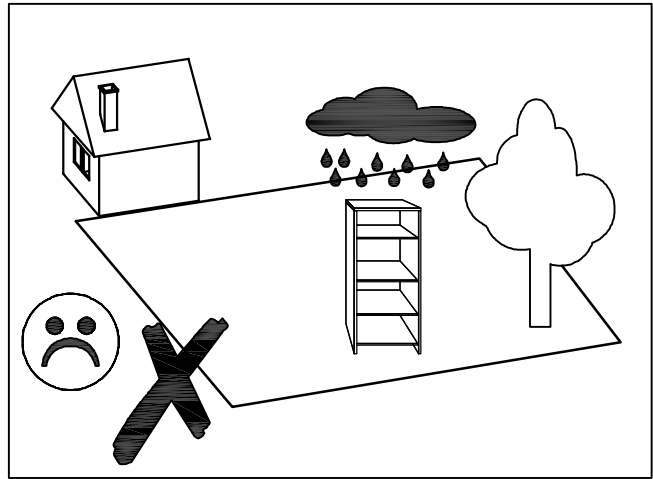
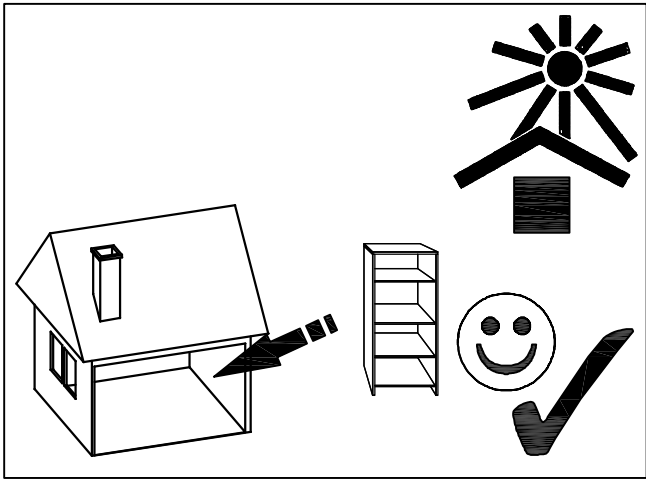





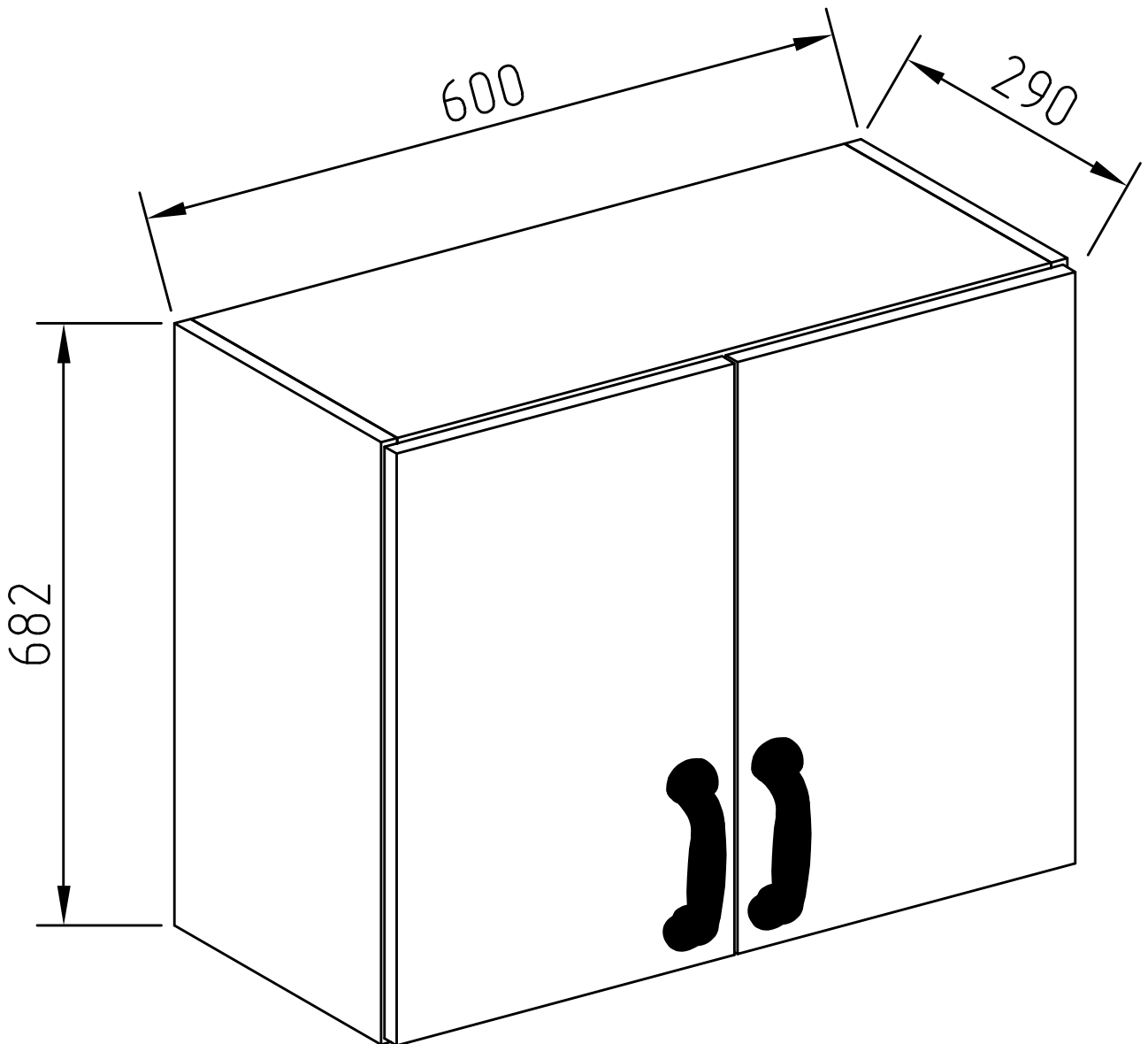

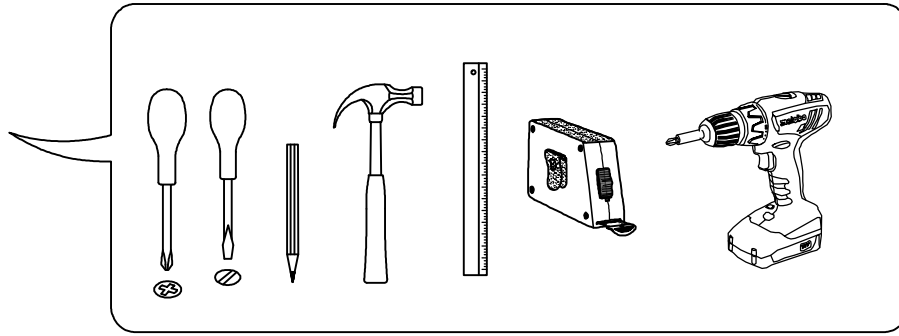
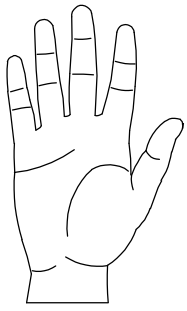

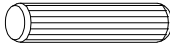

---

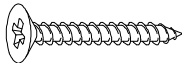
# U 60



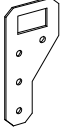
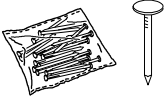

 <b>A1</b> 8*30mm x8	 <b>B</b> $\phi$ 12mm x8	 <b>B1</b> 6,3*50mm x8
 <b>E9</b> 4*16mm x8	 <b>E10</b> 4*30mm x8	 <b>F2</b> 6,3*13mm x8
 <b>I37</b> x2	 <b>J1</b> x8	 <b>L1</b> x4
 <b>O5</b> x2	 <b>R3</b> 1.4*25mm 0.01kg	 <b>R4</b> N°4 x1

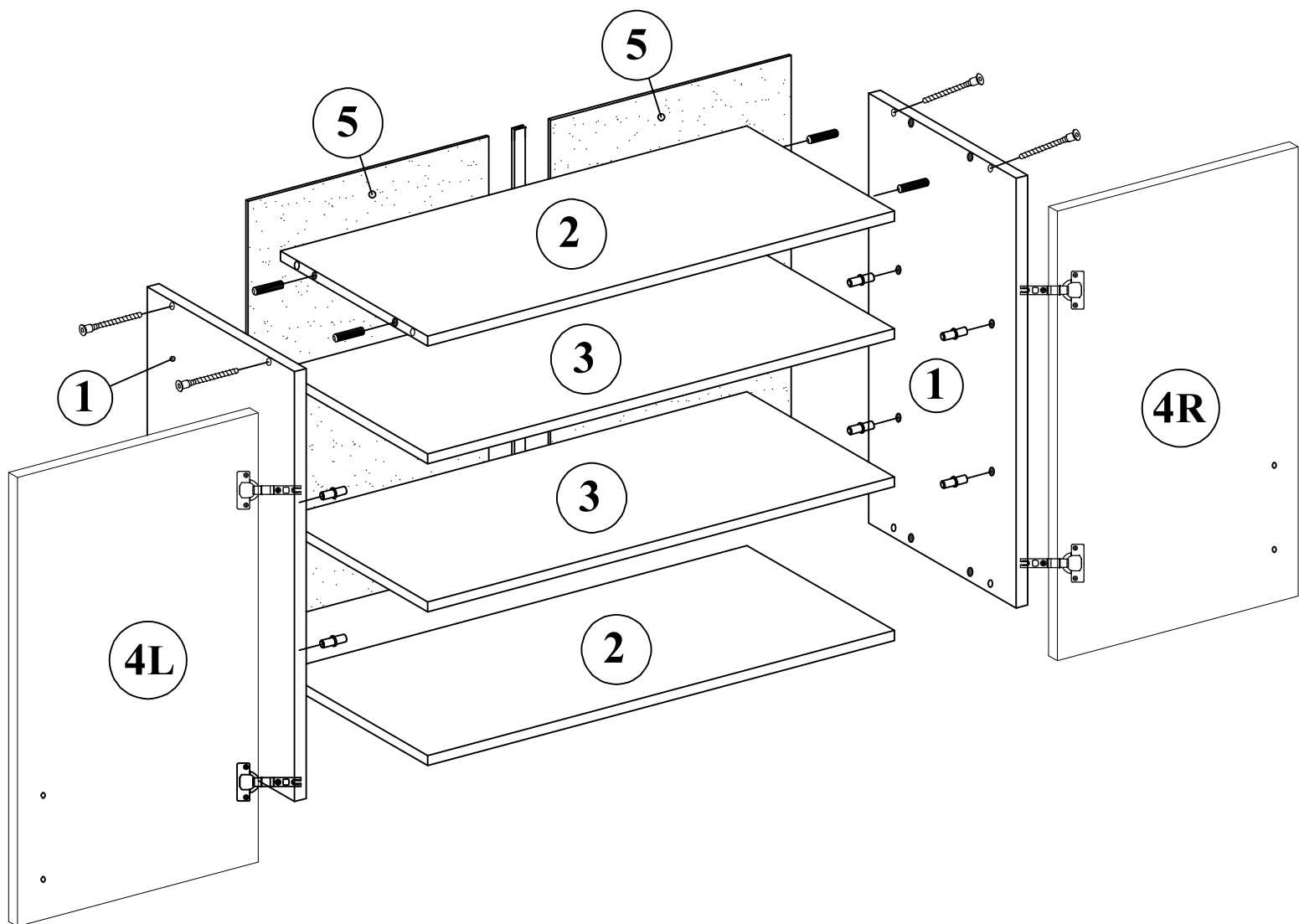

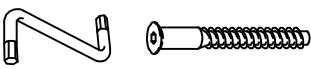
No	a*b	x	N° → ...
1	682x270	x2	
2	567x270	x2	
3	567x245	x2	
4L	670x296	x1	
4R	670x296	x1	
5	296x677	x2	
		x1	

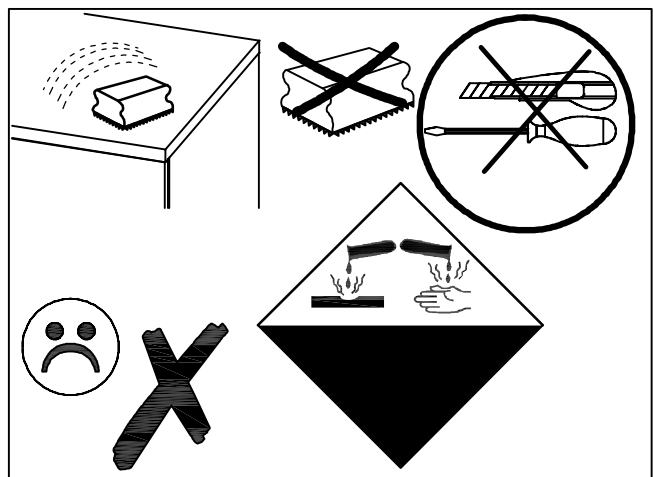
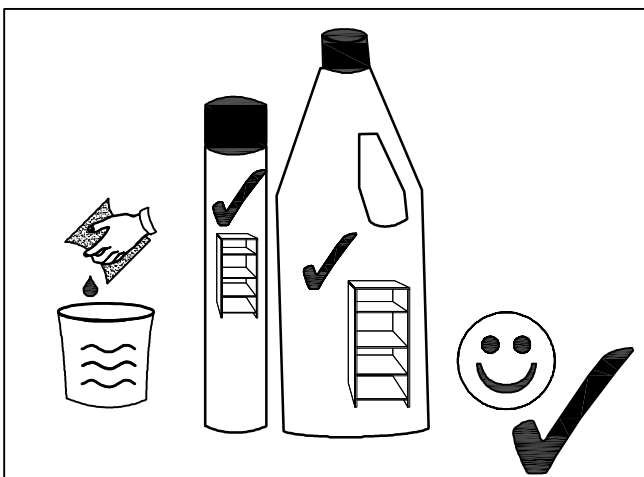
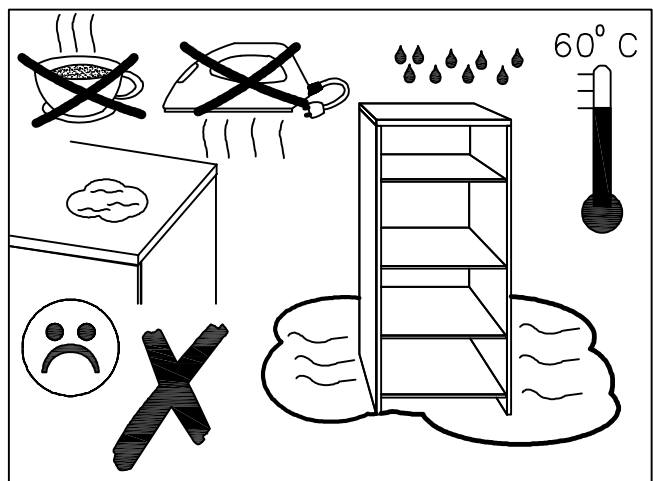
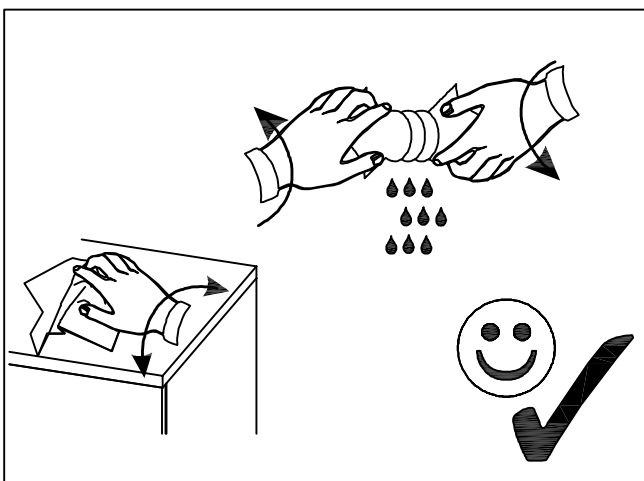
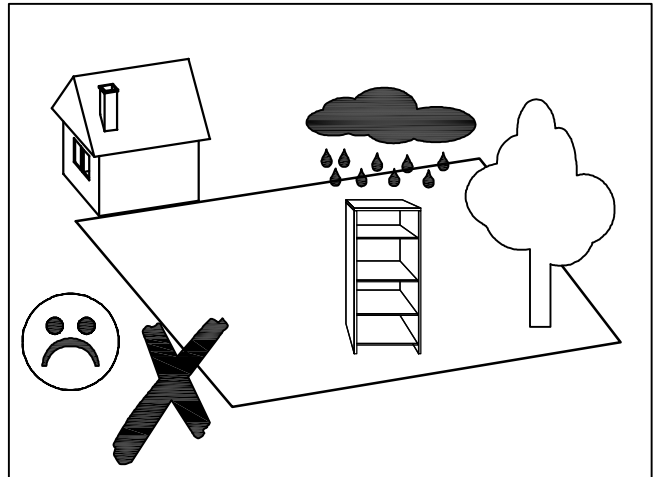
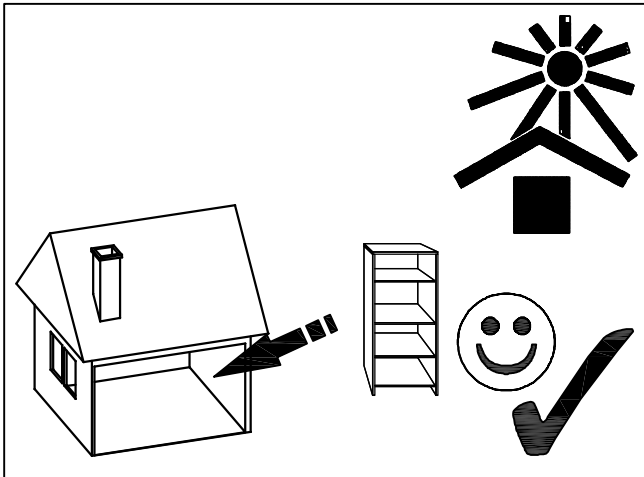







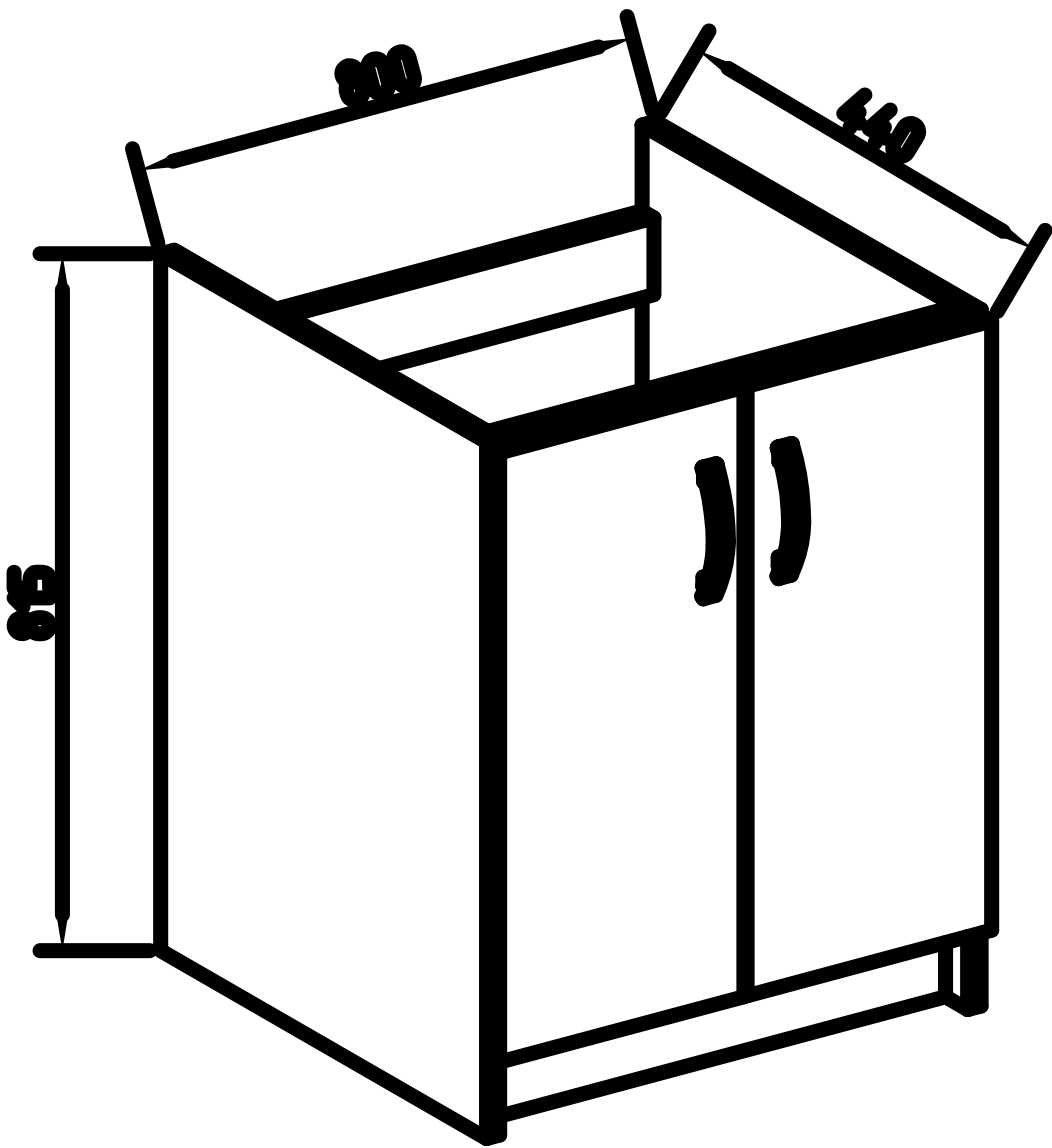

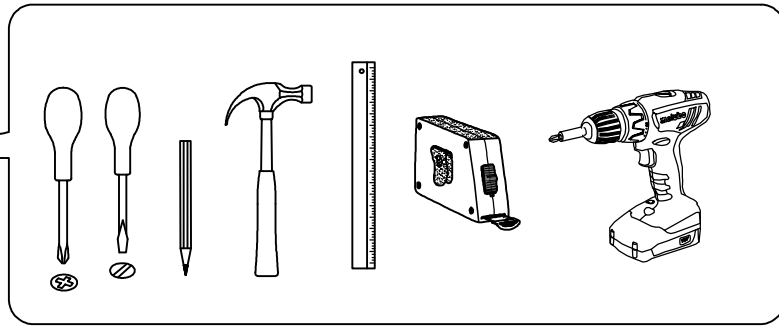
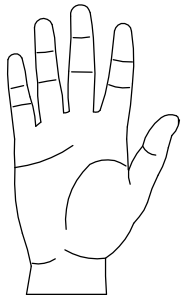
---

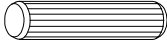
**D 80 W**



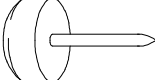
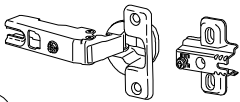
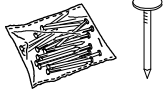
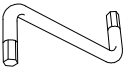

 <b>A1</b> 8*30mm x10	 <b>B</b> $\phi$ 12mm x10	 <b>B1</b> 6,3*50mm x10
 <b>E9</b> 4*16mm x8	 <b>E10</b> 4*30mm x4	 <b>F2</b> 6,3*13mm x8
 <b>I37</b> x2	 <b>K1</b> x4	 <b>L1</b> x4
 <b>R3</b> 1.4*25mm 0.01kg	 <b>R4</b> N°4 x1	

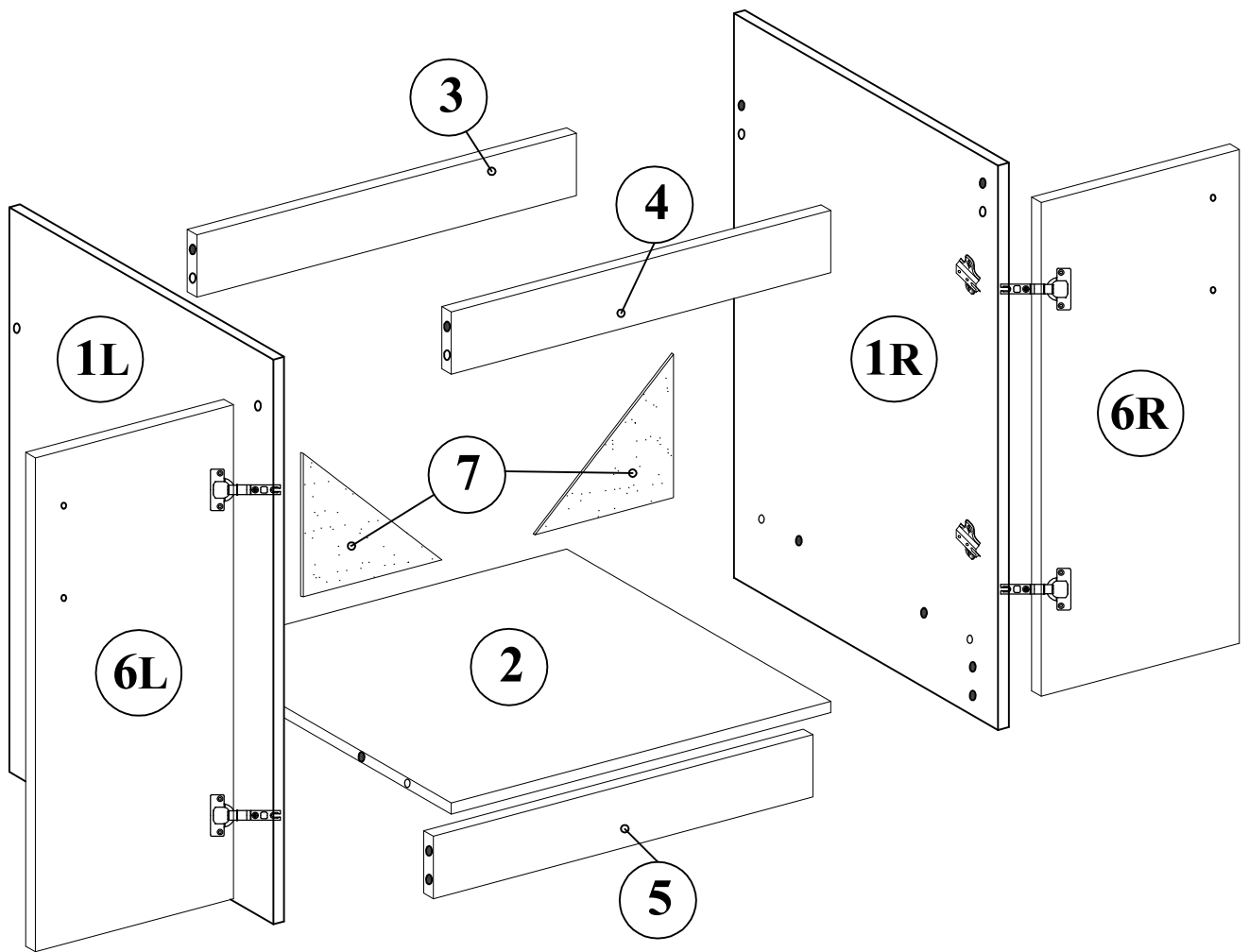

No	a*b	x	N <sup>o</sup> → ...
1L	815x440	x1	
1R	815x440	x1	
2	767x440	x1	
3	767x90	x1	
4	767x90	x1	
5	767x90	x1	
6L	713x396	x1	
6R	713x396	x1	
7	200x200	x2	
		x1	

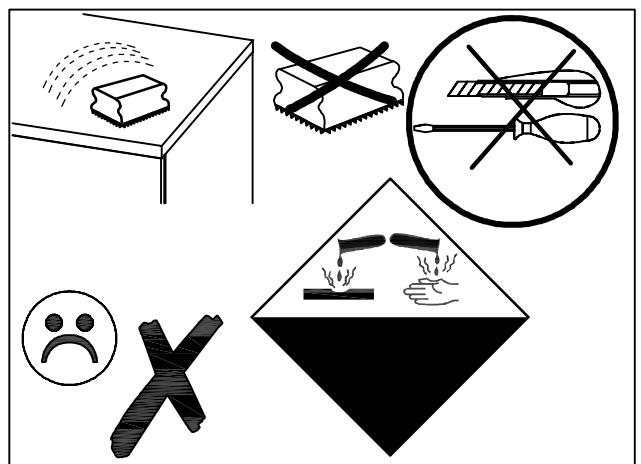
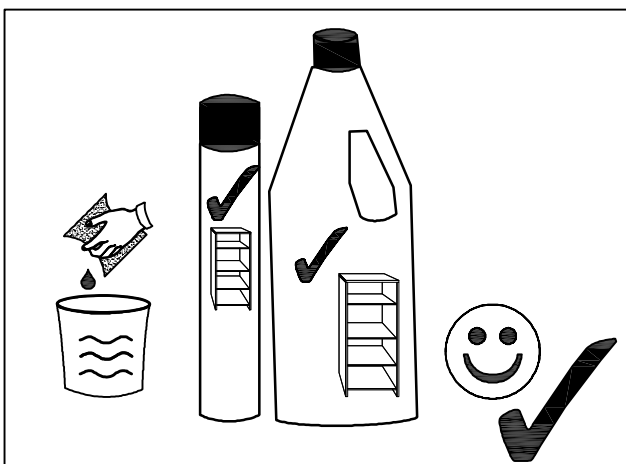
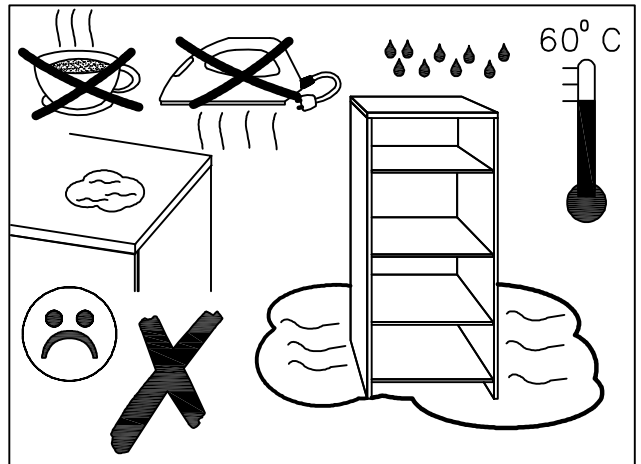
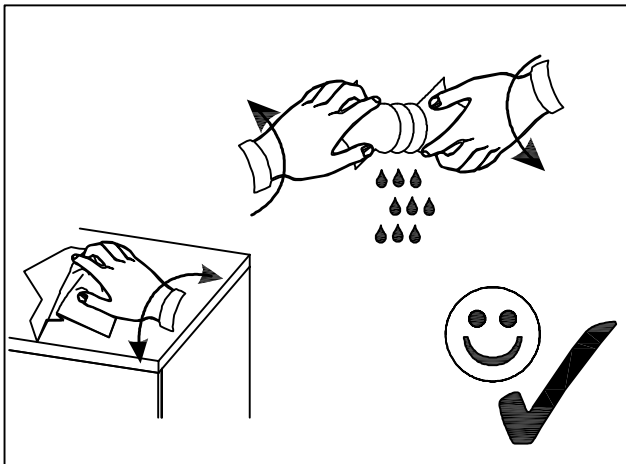
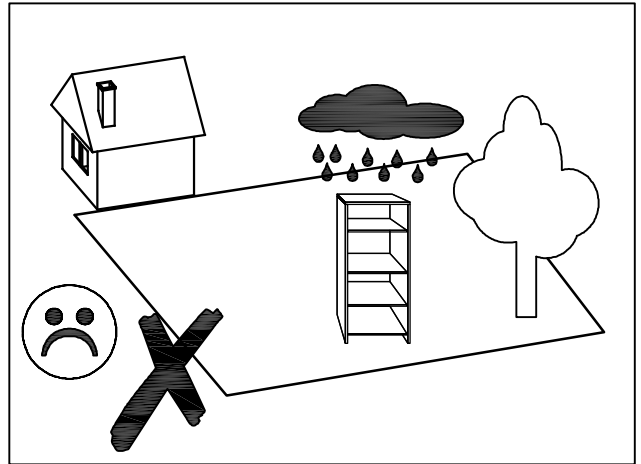
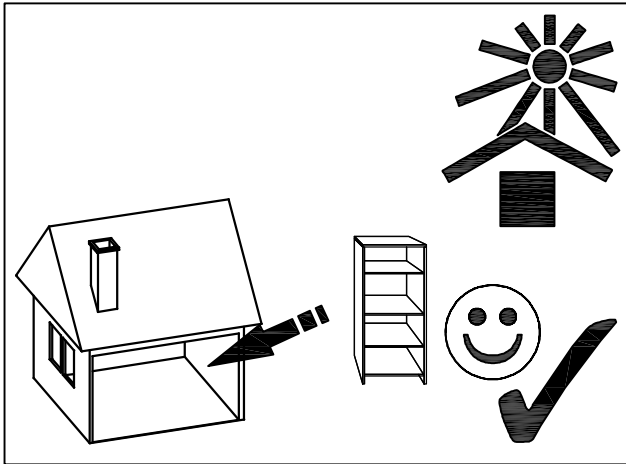
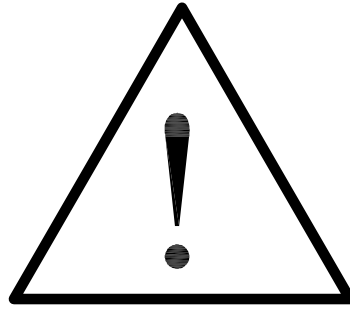





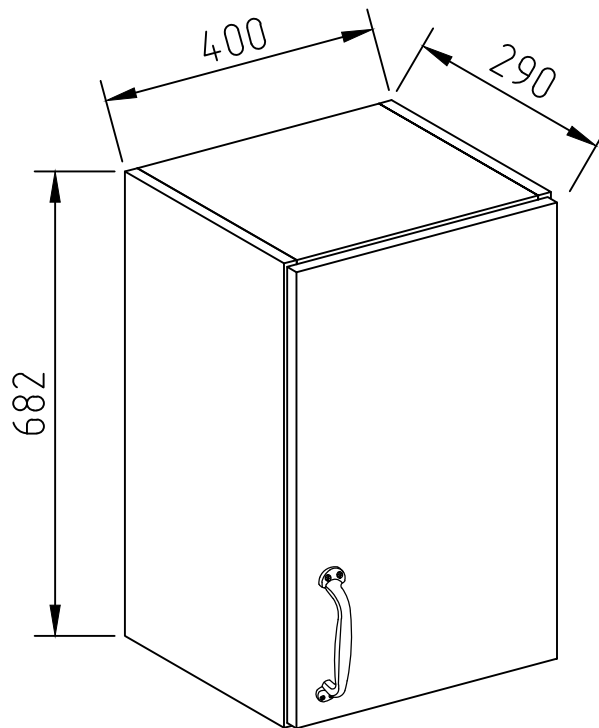

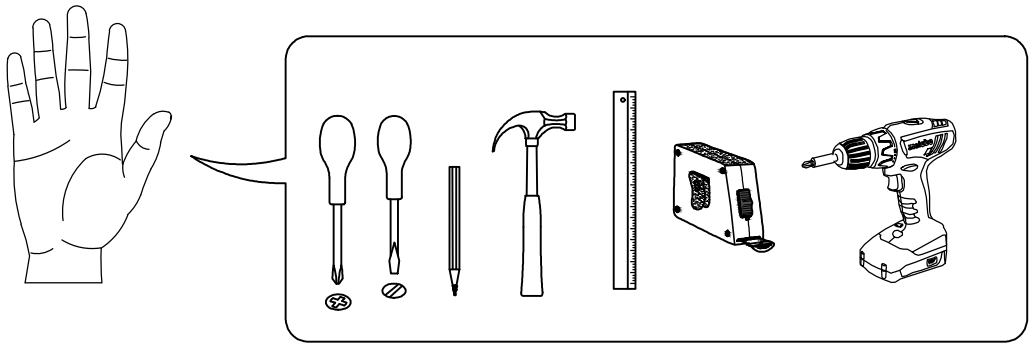



---

# U 40



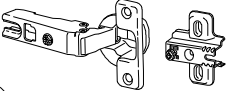
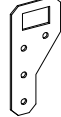

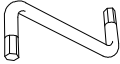
 <b>A1</b> 8*30mm x8	 <b>B</b> $\phi$ 12mm x8	 <b>B1</b> 6,3*50mm x8
 <b>E9</b> 4*16mm x4	 <b>E10</b> 4*30mm x10	 <b>Ea1</b> 3,5*27mm x2
 <b>F2</b> 6,3*13mm x4	 <b>I37</b> x1	 <b>J1</b> x12
 <b>L1</b> x2	 <b>O5</b> x2	 <b>R3</b> 1.4*25mm 0.01kg
 <b>R4</b> N°4 x1		

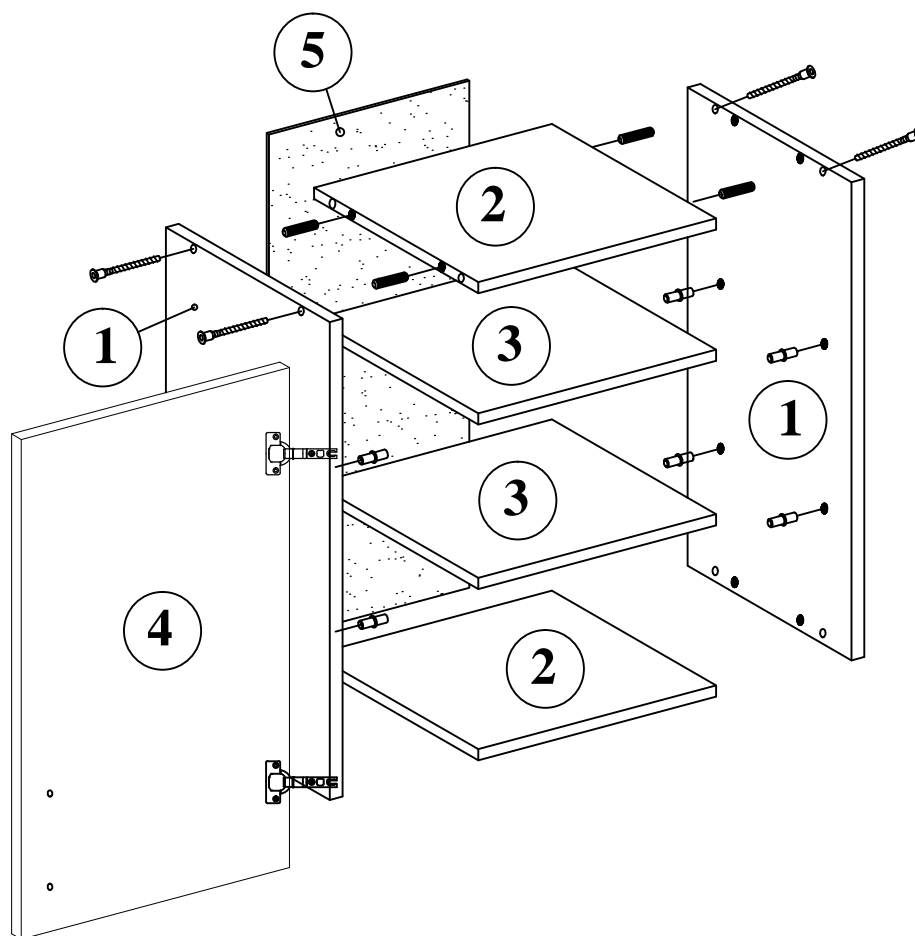

	a*b	x	Nº → ...
1	682x270	x2	
2	367x270	x2	
3	367x245	x2	
4	670x396	x1	
5	396x677	x1	
		x1	

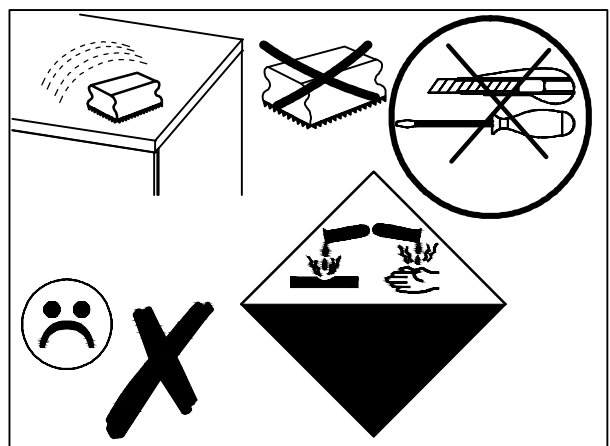
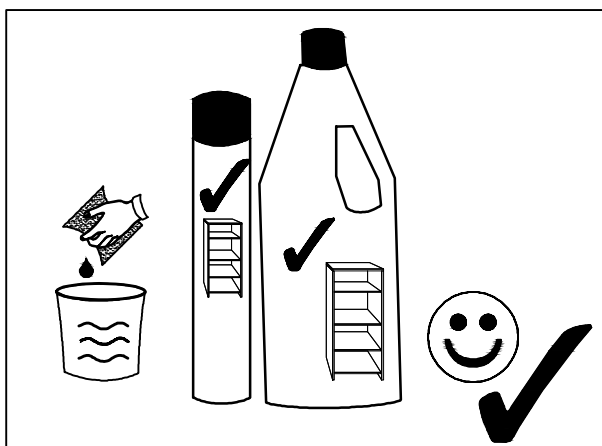
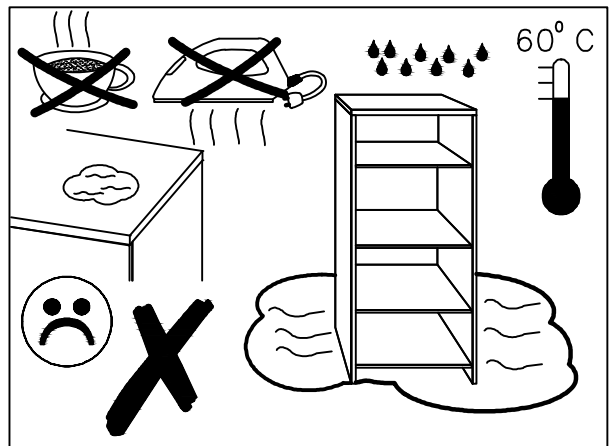
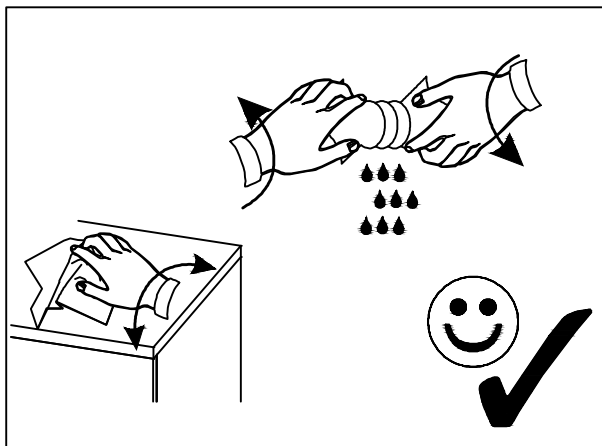
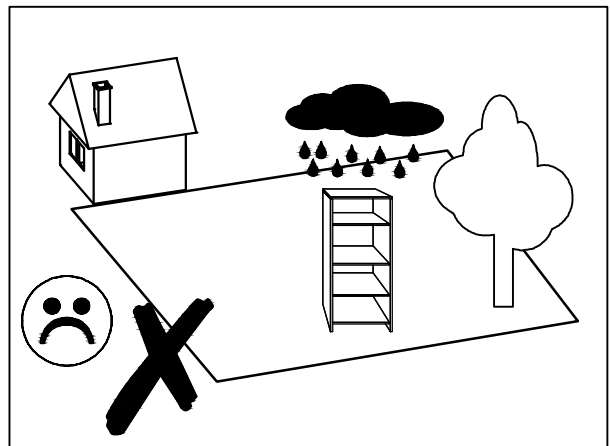
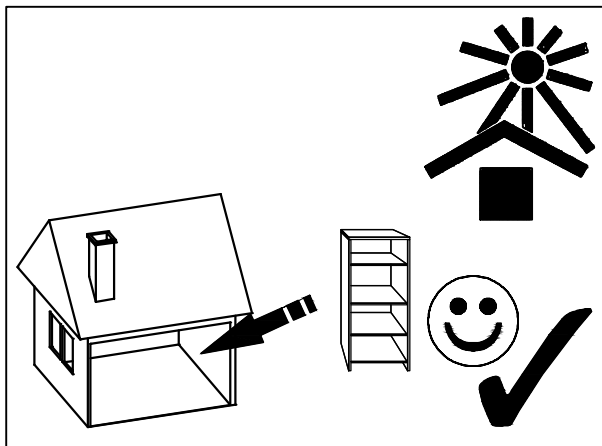
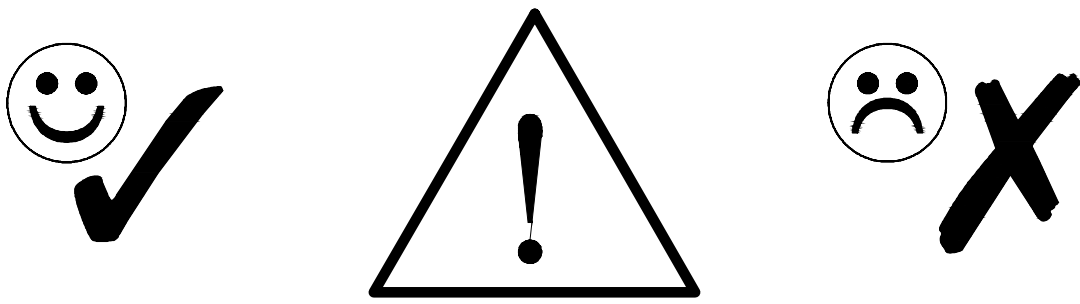







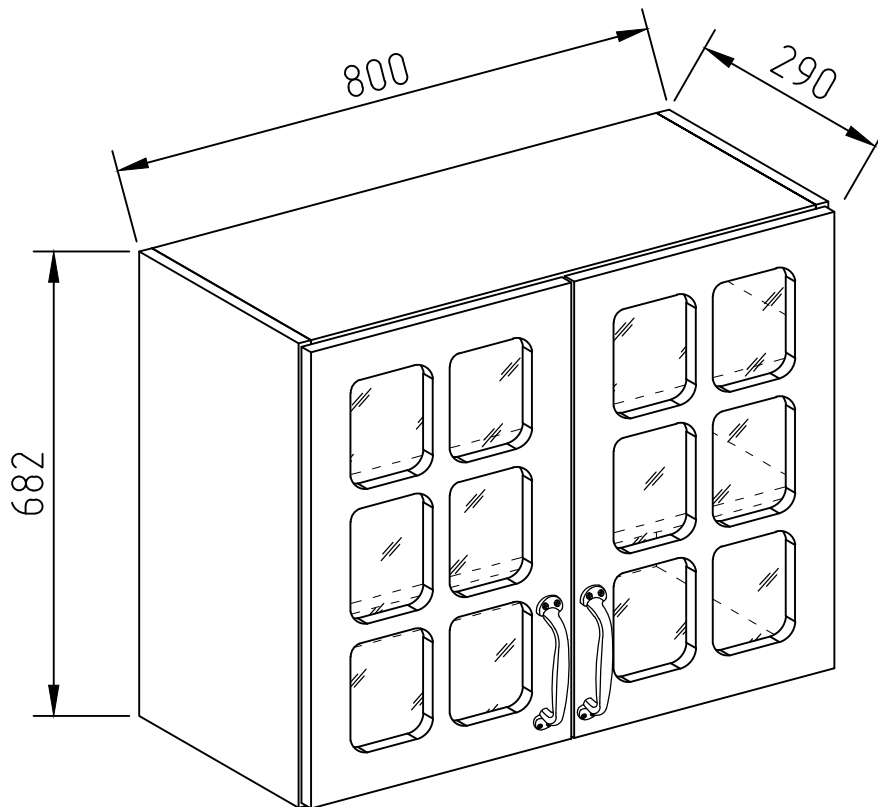

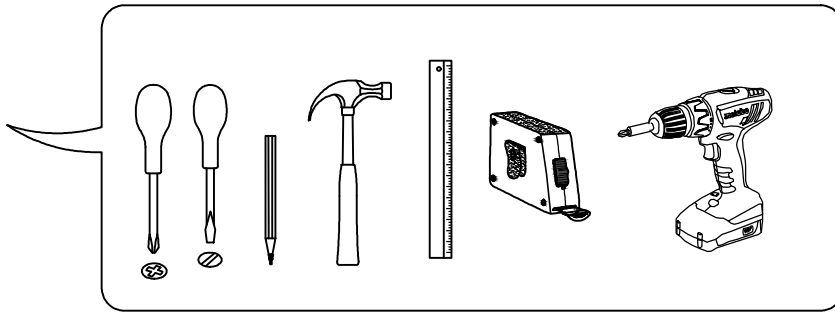
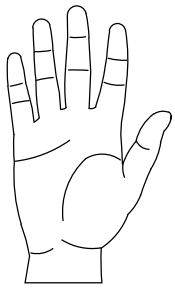





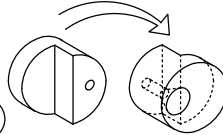

---

# U 80 GL



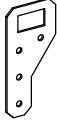

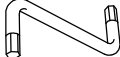
 <b>A1</b> 8*30mm x8	 <b>B</b> $\phi$ 12mm x8	 <b>B1</b> 6,3*50mm x8
 <b>E2</b> 3*13mm x16	 <b>E9</b> 4*16mm x8	 <b>E10</b> 4*30mm x8
 <b>Ea1</b> 3,5*27mm x4	 <b>F2</b> 6,3*13mm x8	 <b>H10</b> x16
 <b>I37</b> x2	 <b>J1</b> x8	 <b>L1</b> x4
 <b>O5</b> x2	 <b>R3</b> 1.4*25mm 0.01kg	 <b>R4</b> N°4 x1

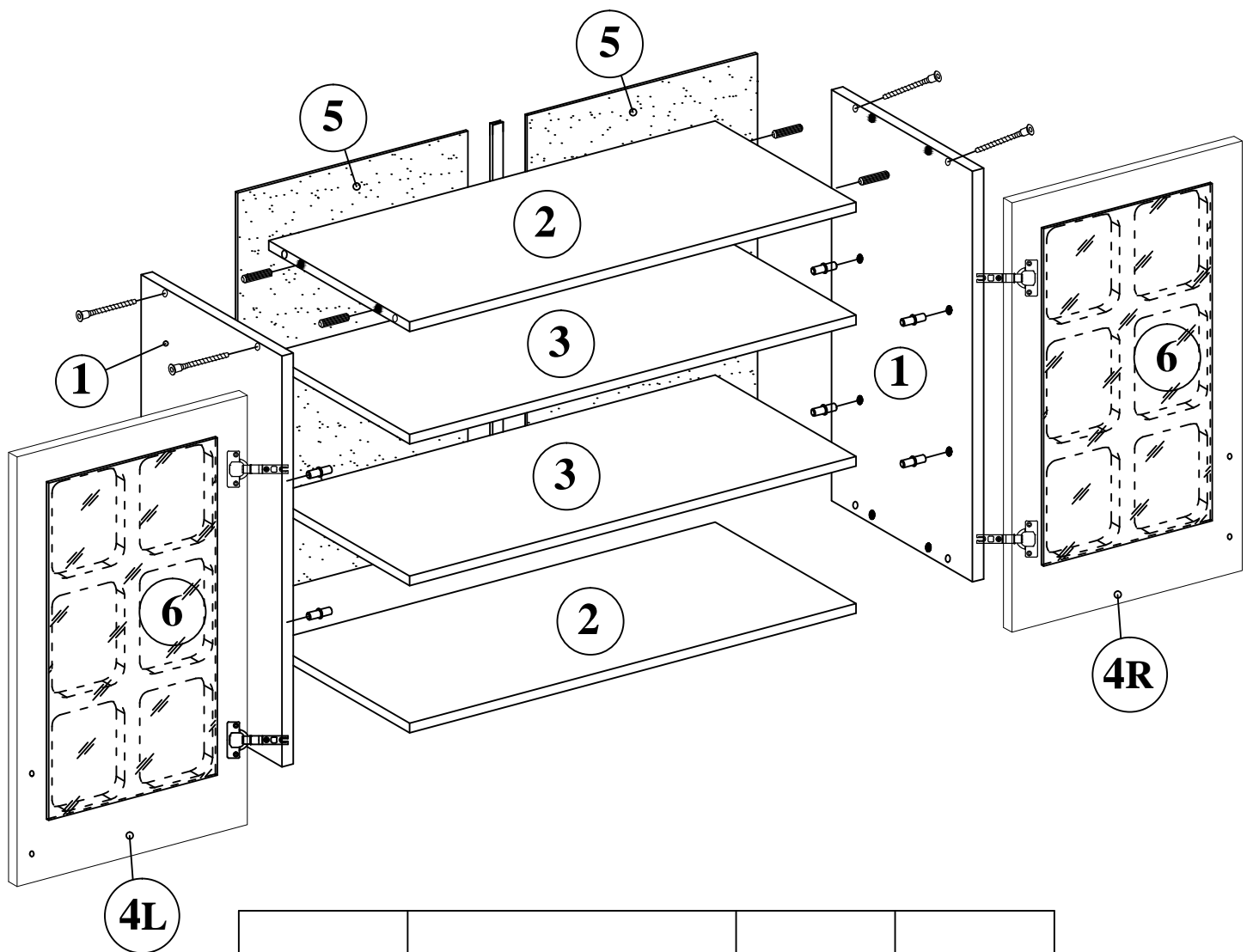

	a*b	x	N° → ...
1	682x270	x2	
2	367x270	x2	
3	367x245	x2	
4L	670x396	x1	
4R	670x396	x1	
5	396x677	x2	
6	560x290	x2	
		x1	

