

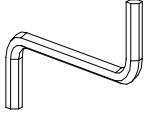

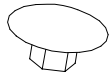
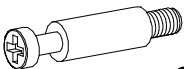

W2  x1	I7a  x7 ø18
K5  x23	K1  x23 ø15x12

N31  M8x50 x6
--

B3  ø8x50 x20
--

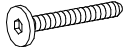
B1  ø8x35 x6

1

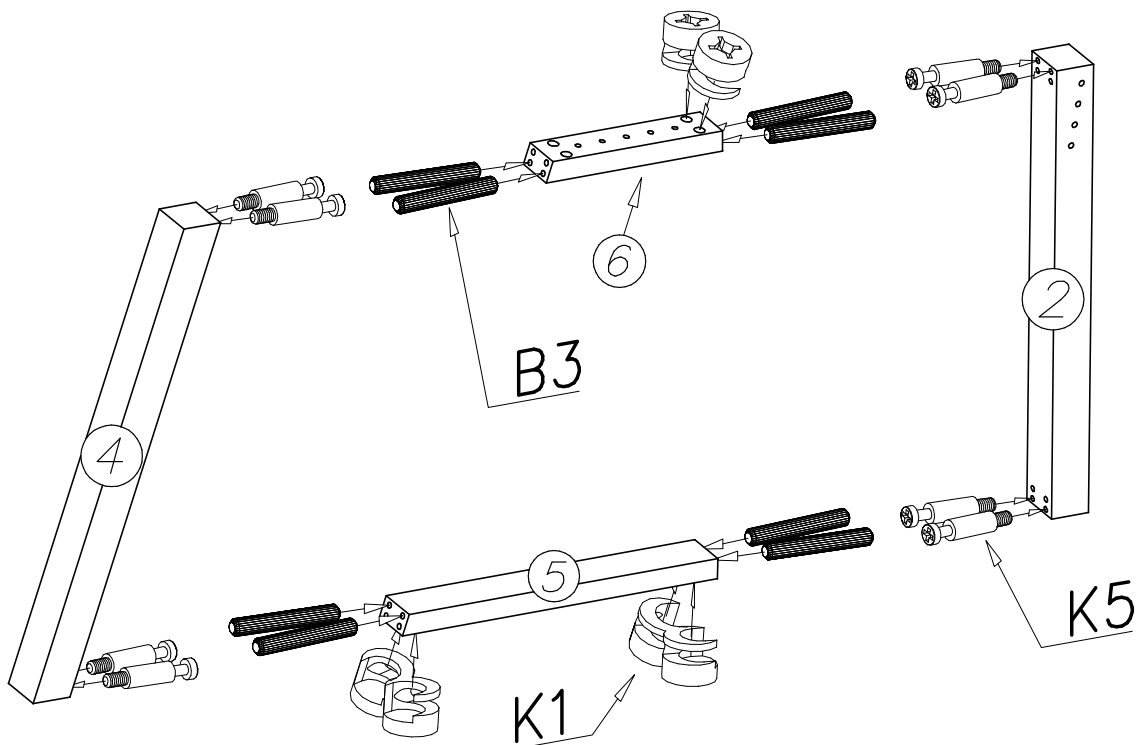
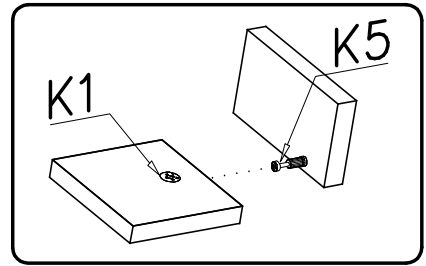
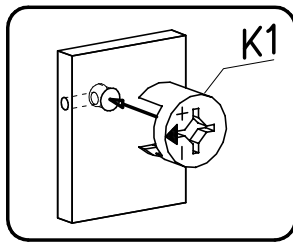
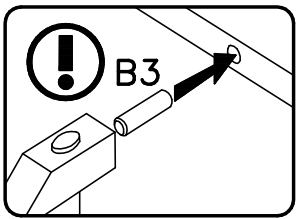
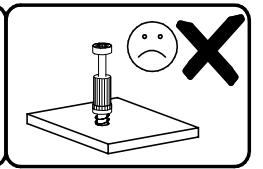
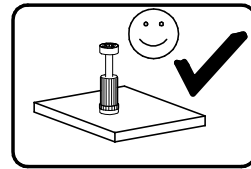
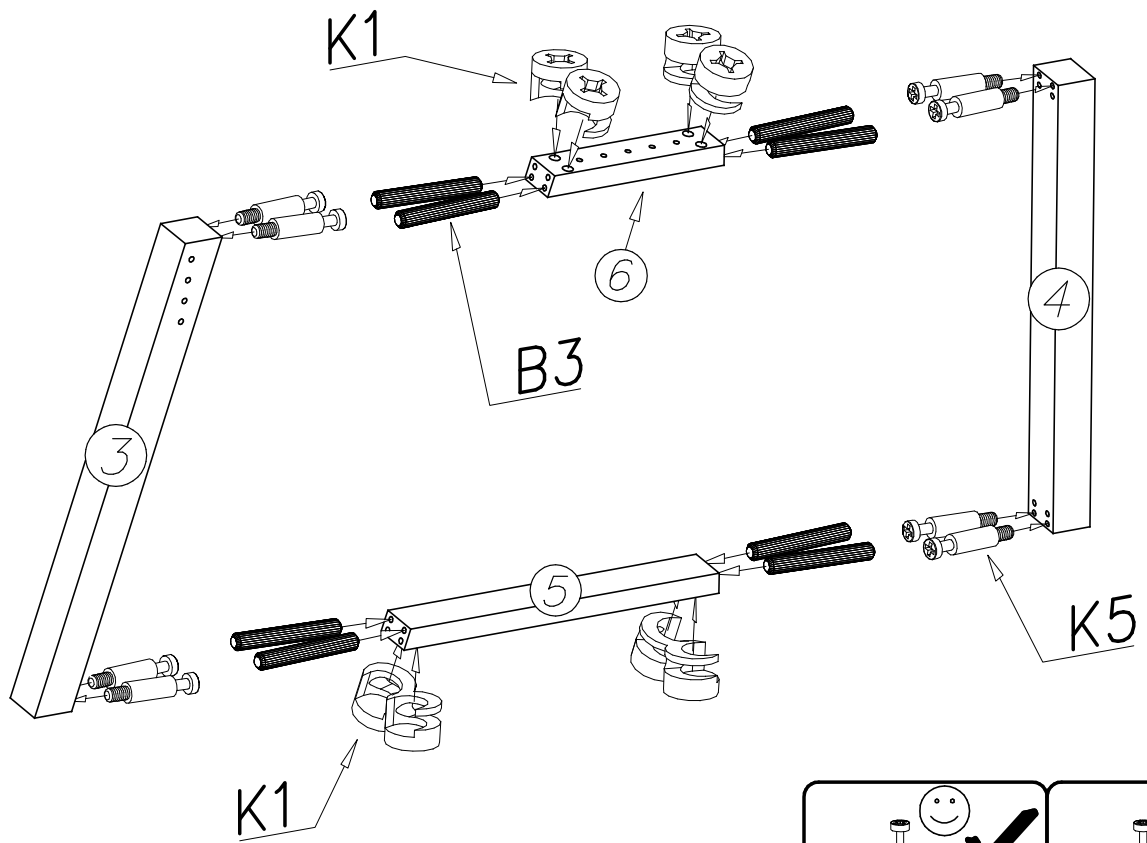

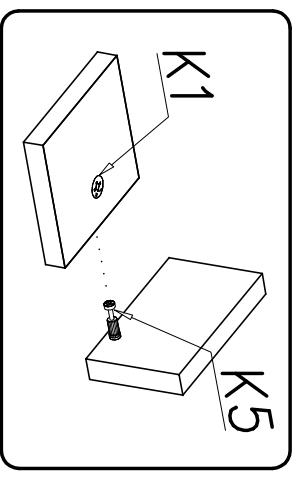
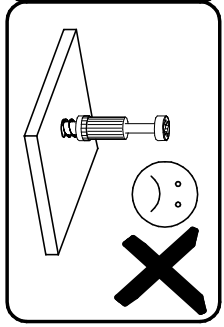
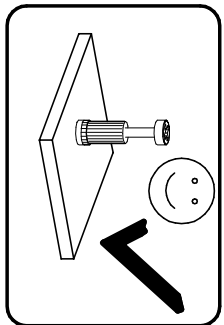
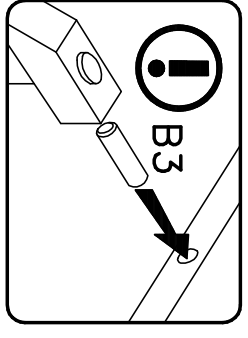
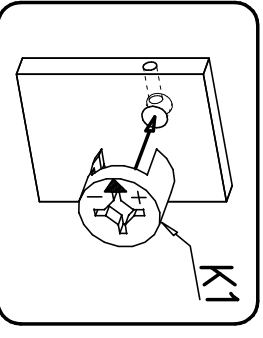
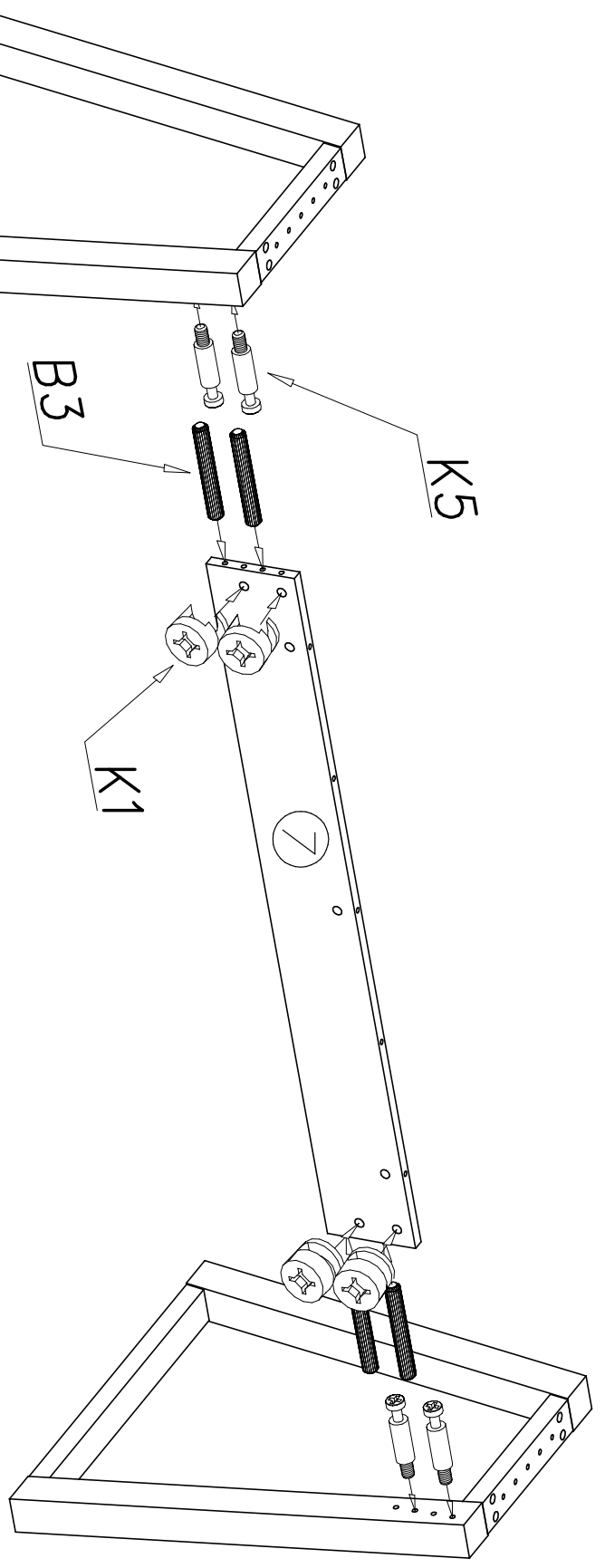

III

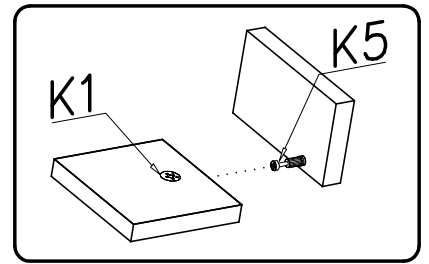
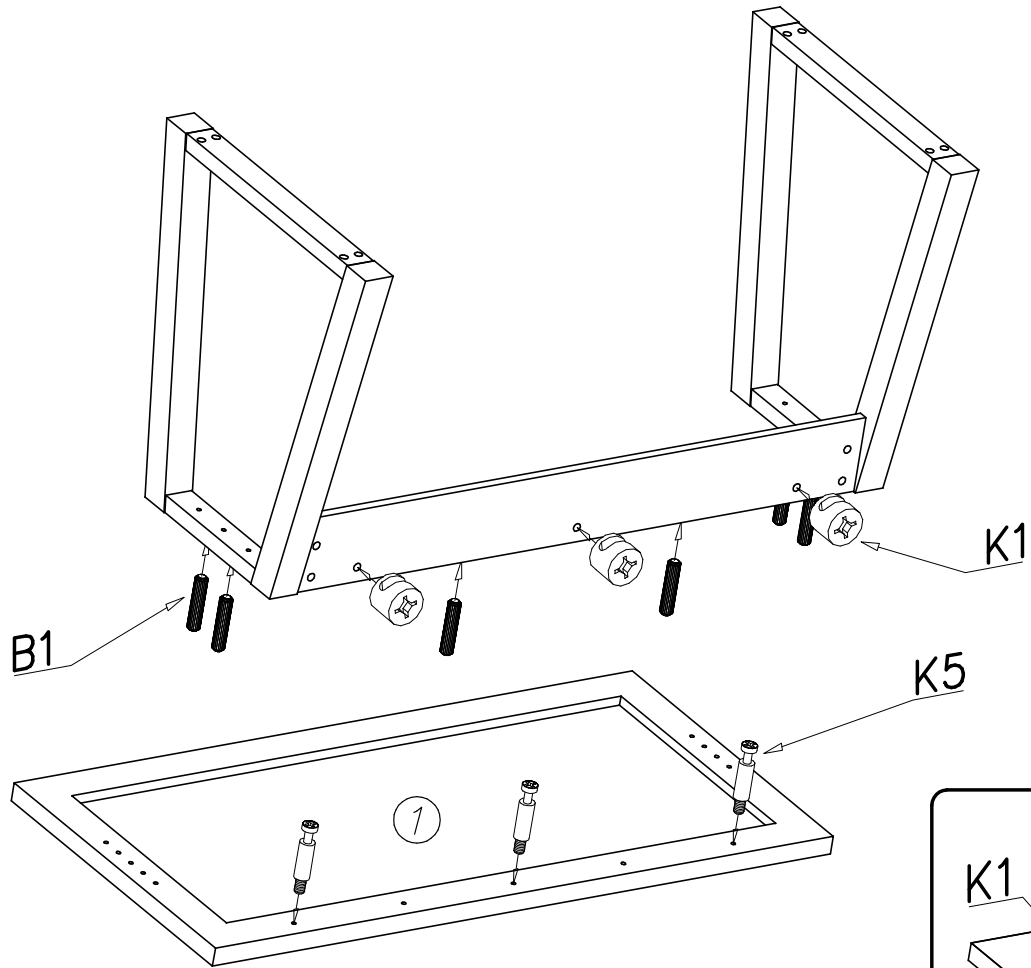

IV

