

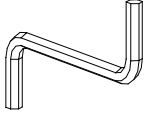

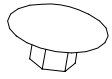
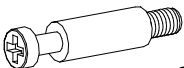

W2  x1	I7a  ø18 x7
---	---

K5  x23	K1  ø15x12 x23
---	--

N31  M8x50 x6
---

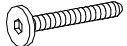
B3  ø8x50 x20
---

B1  ø8x35 x6
--

1

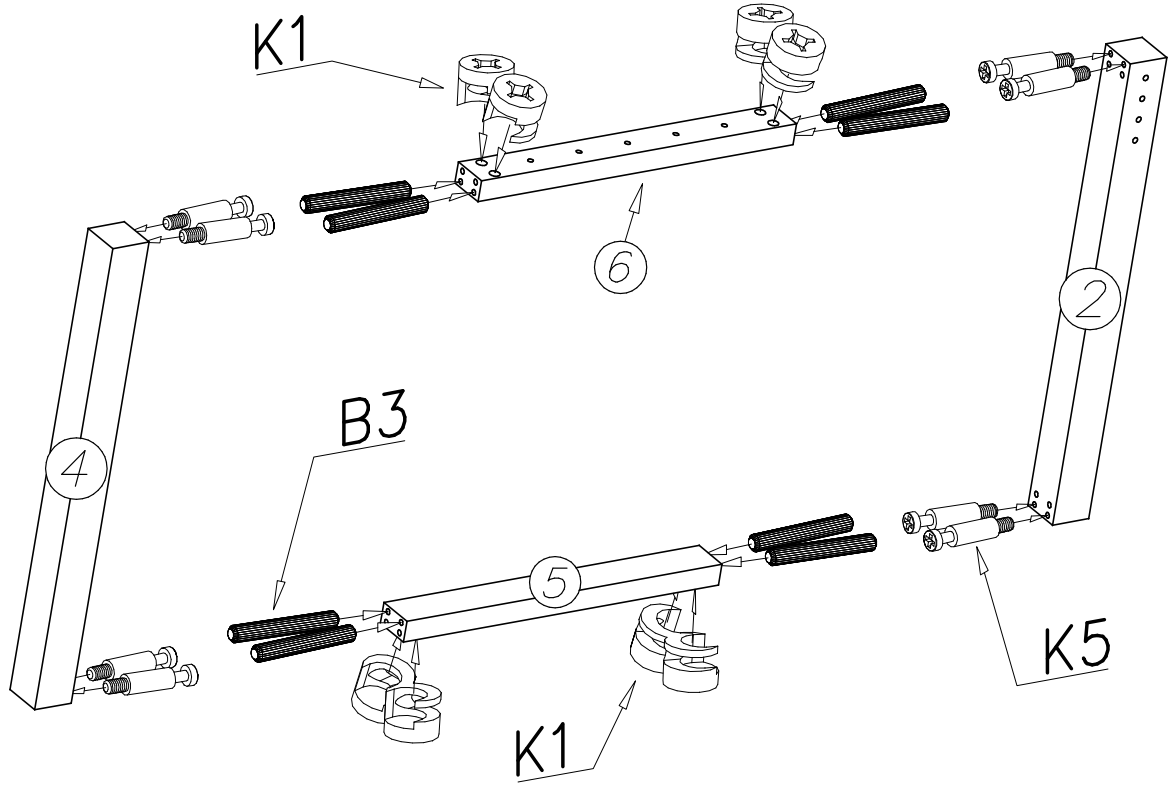
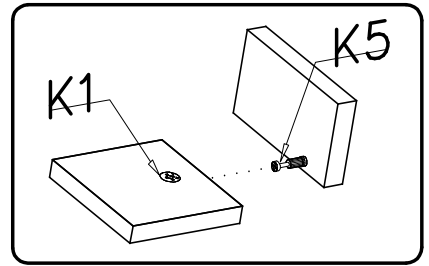
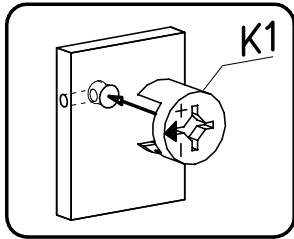
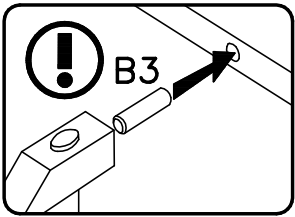
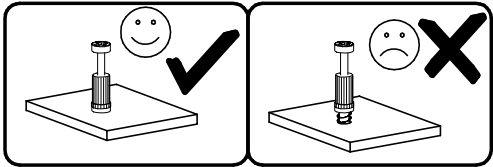
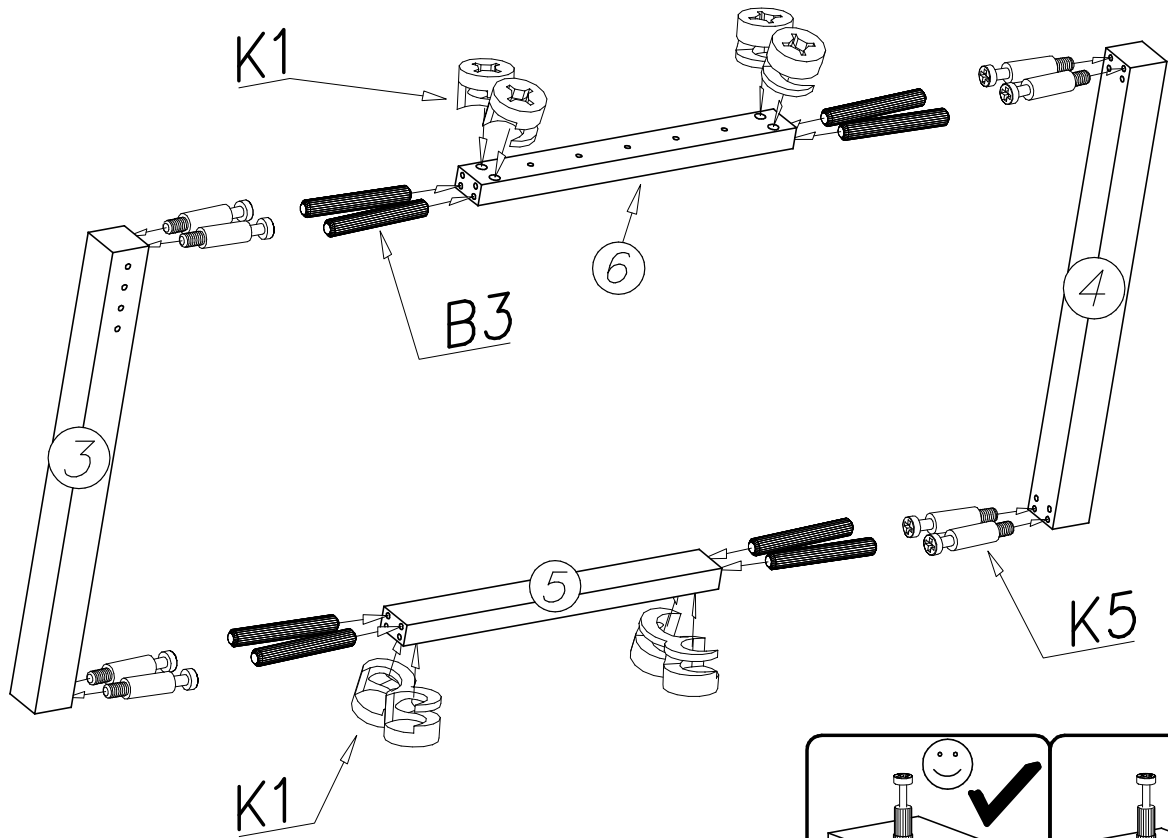

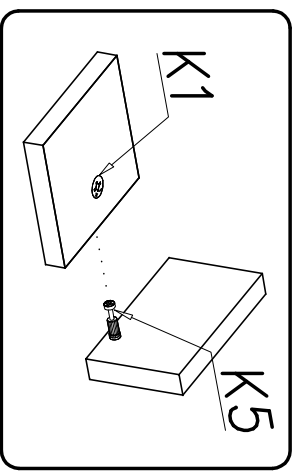
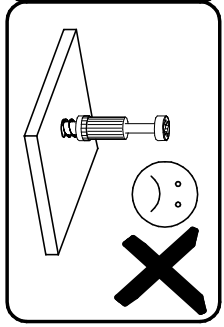
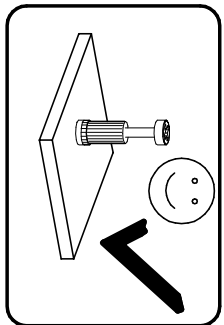
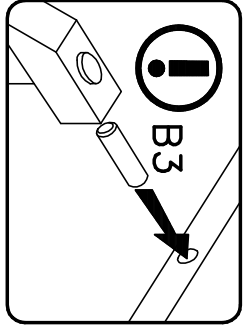
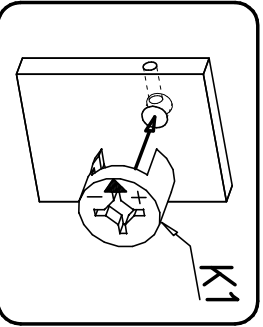
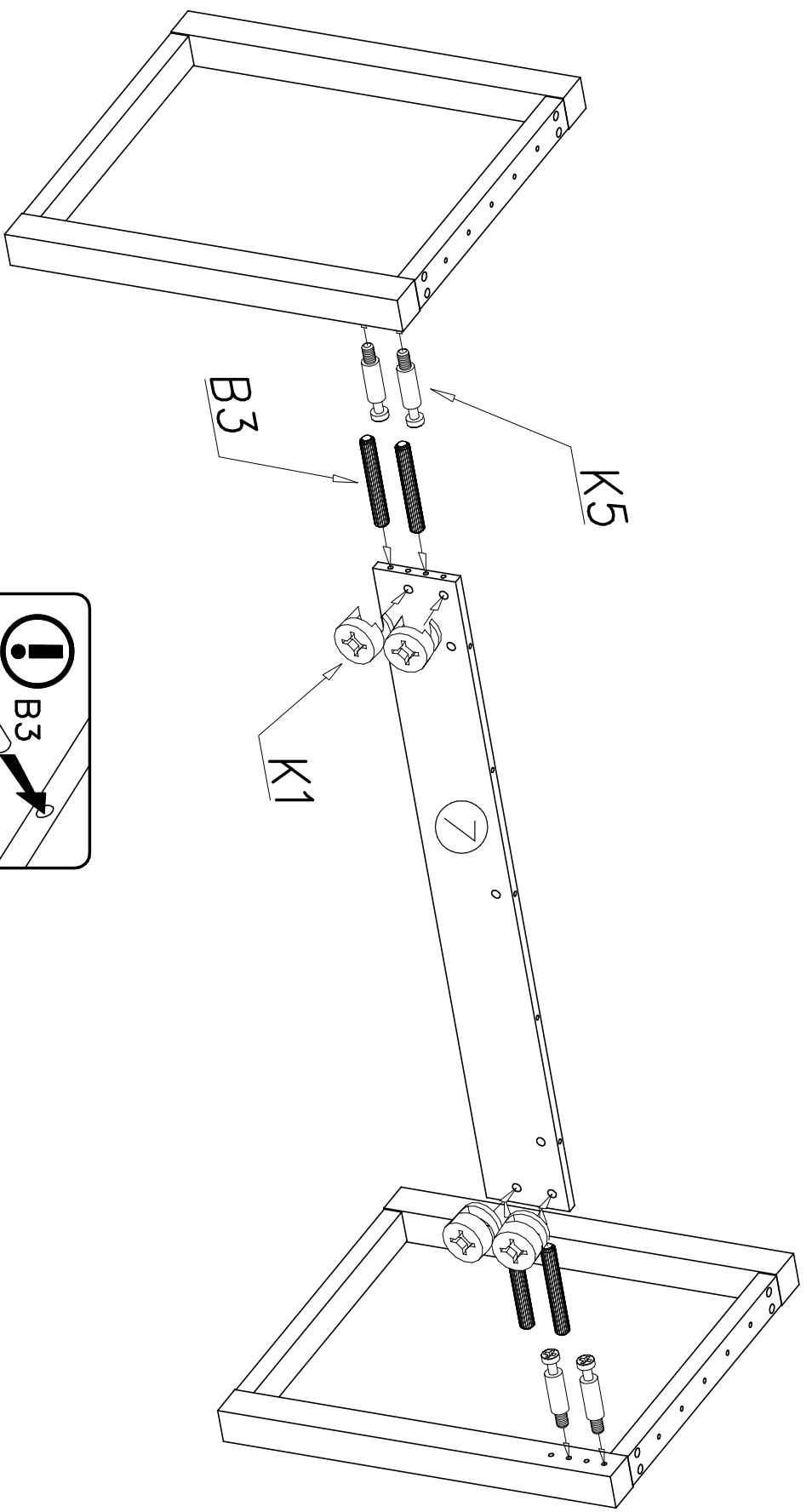

III

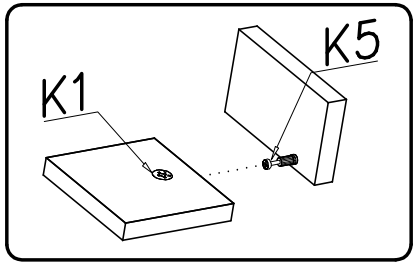
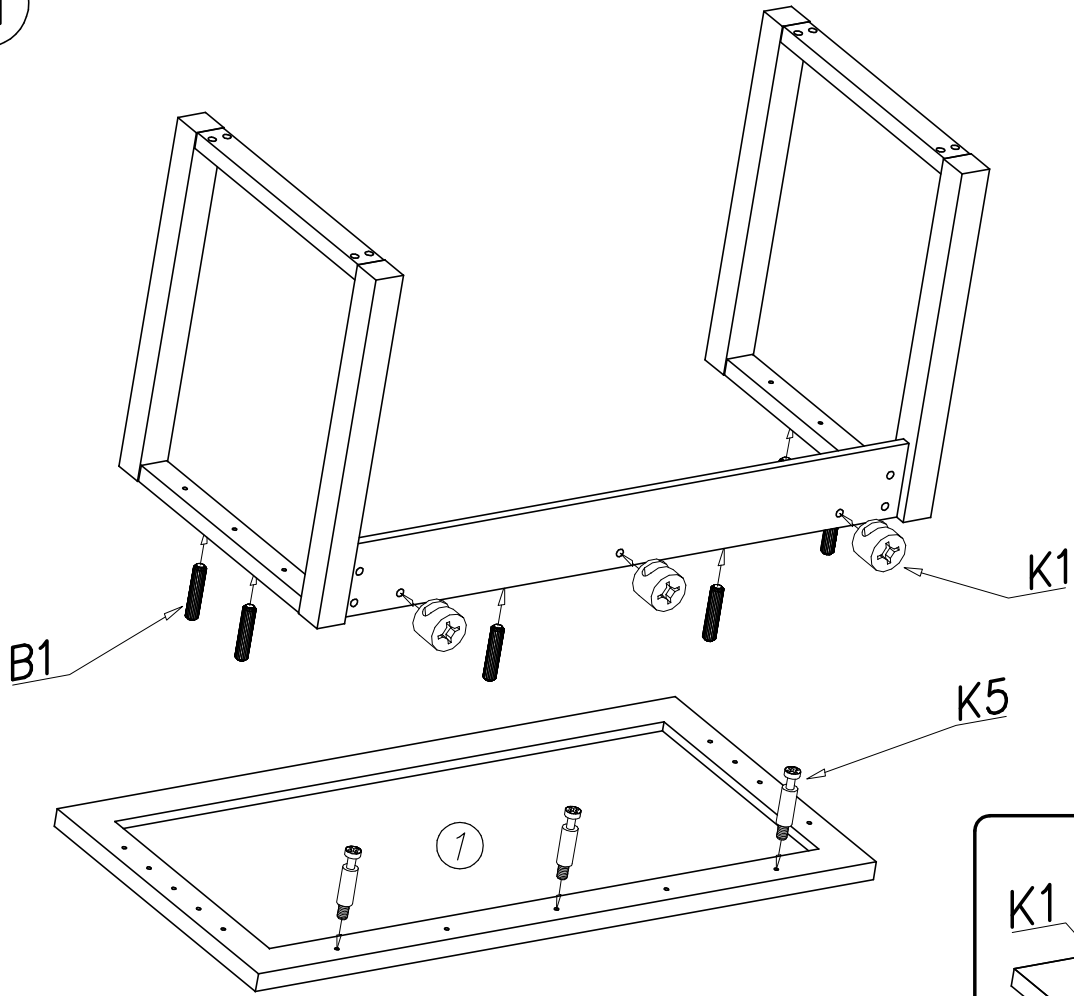

IV

