

ERWIN 235

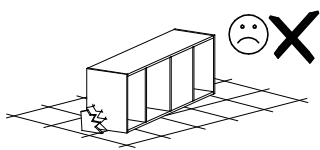

Narzędzia potrzebne do montażu

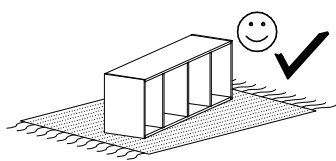
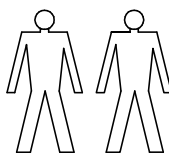
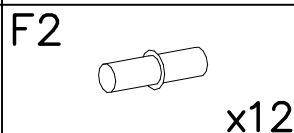
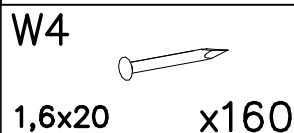
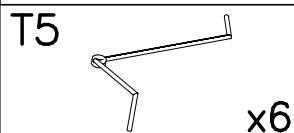
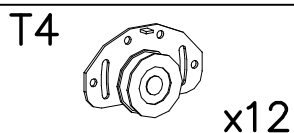
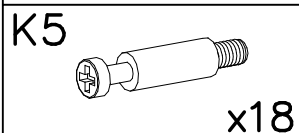
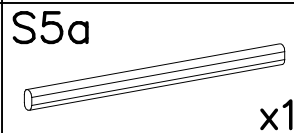
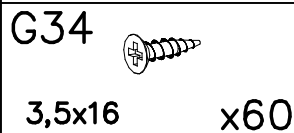
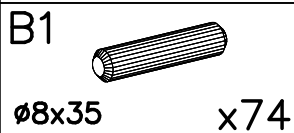
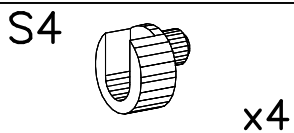
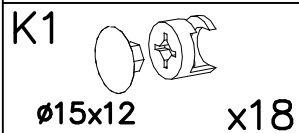
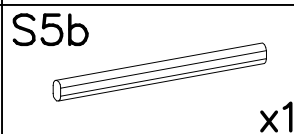
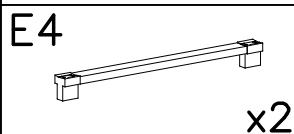
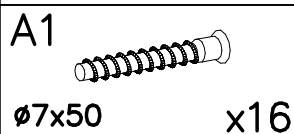
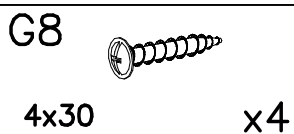
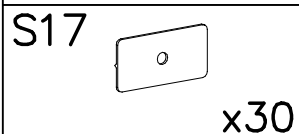
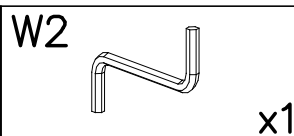
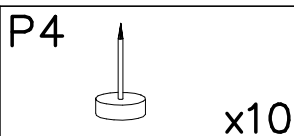
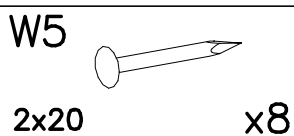
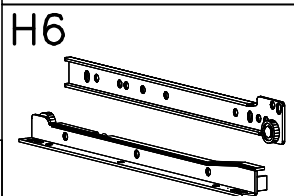
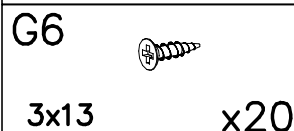
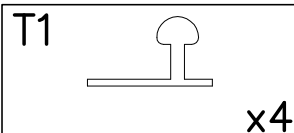
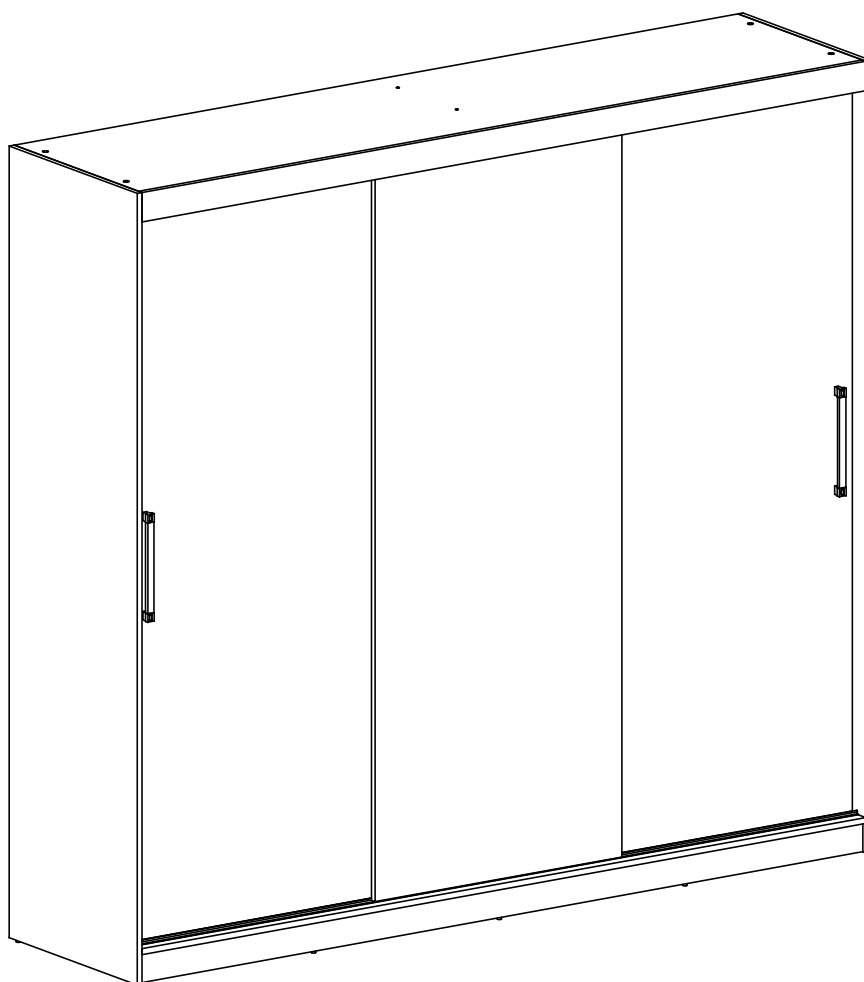
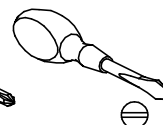
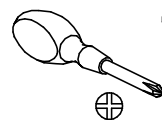
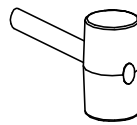
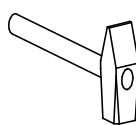

1

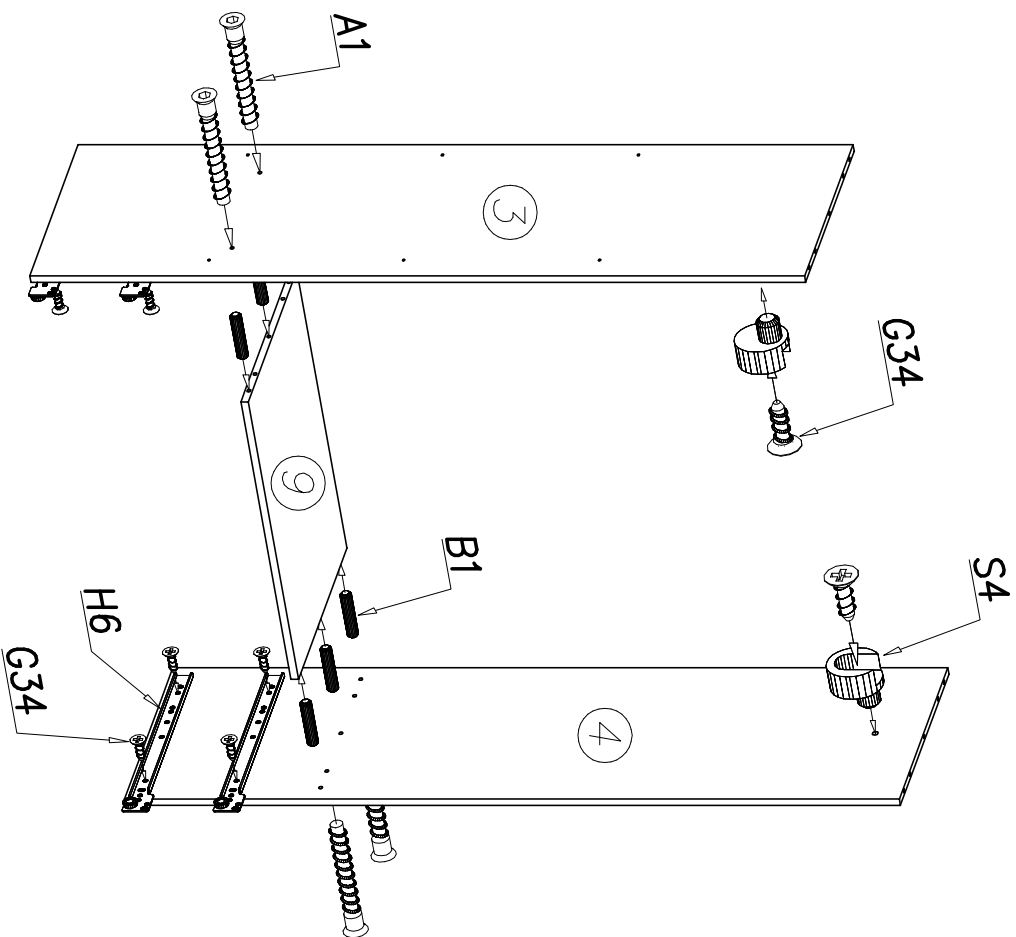

2

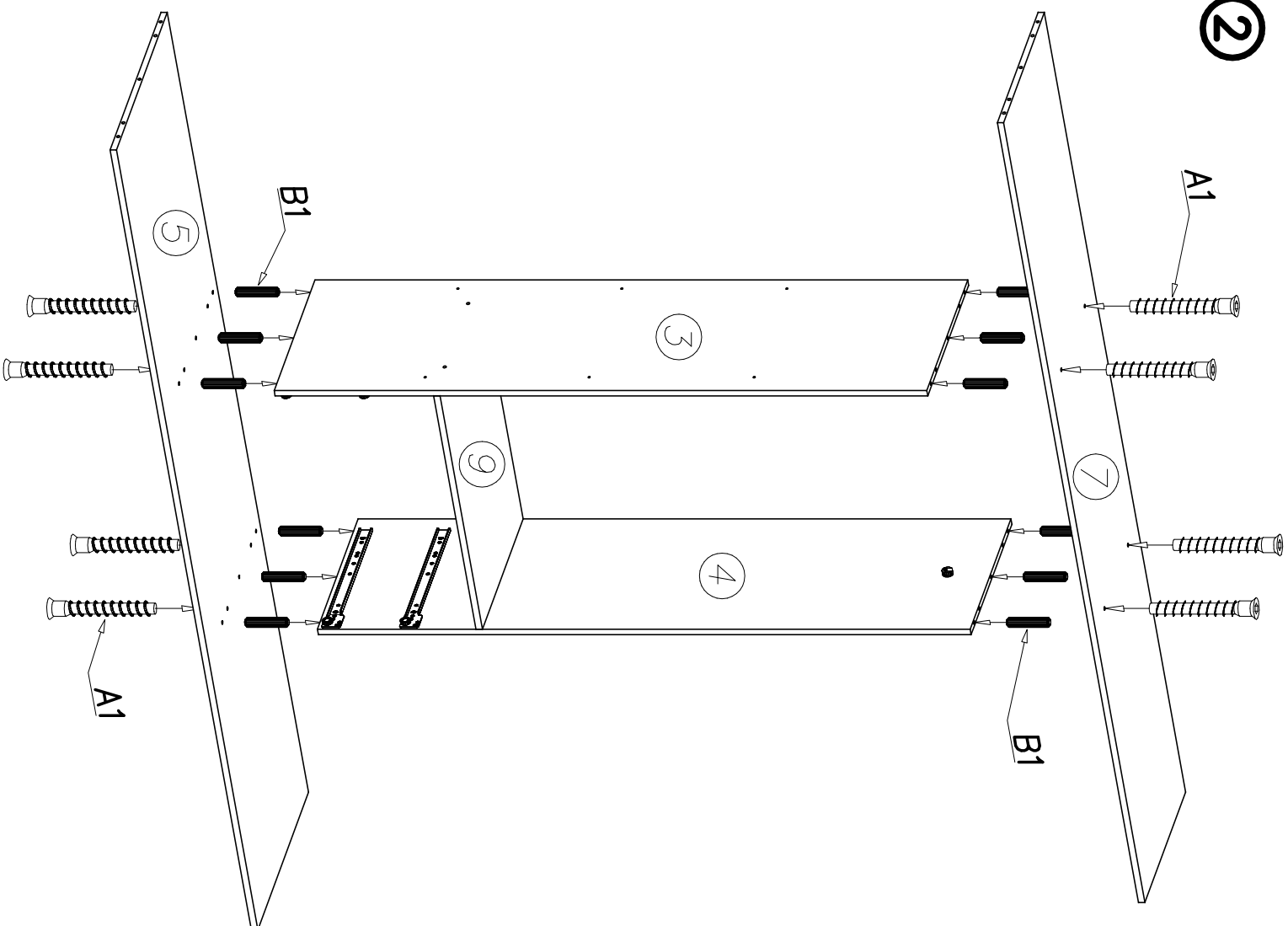

3

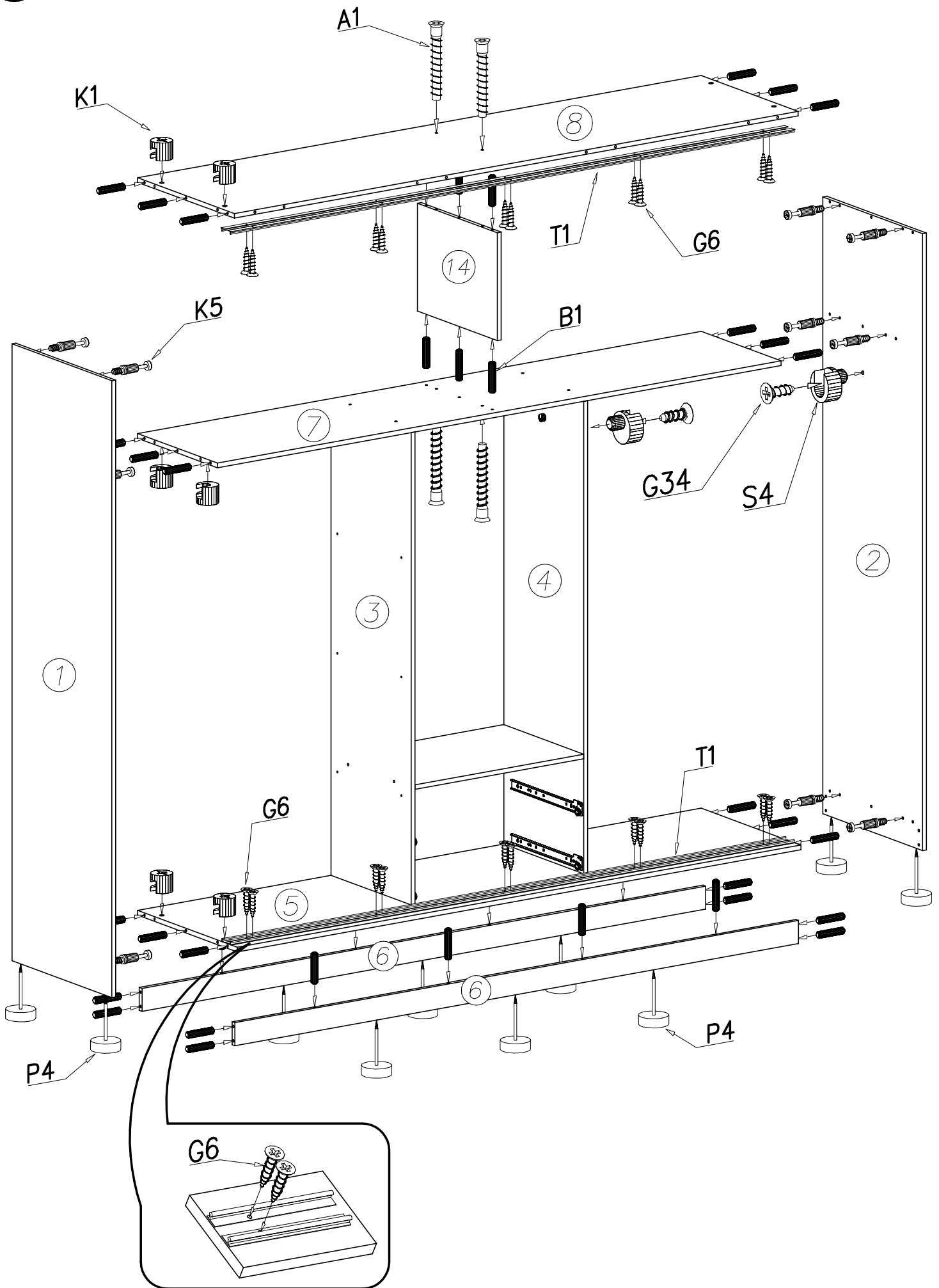

4

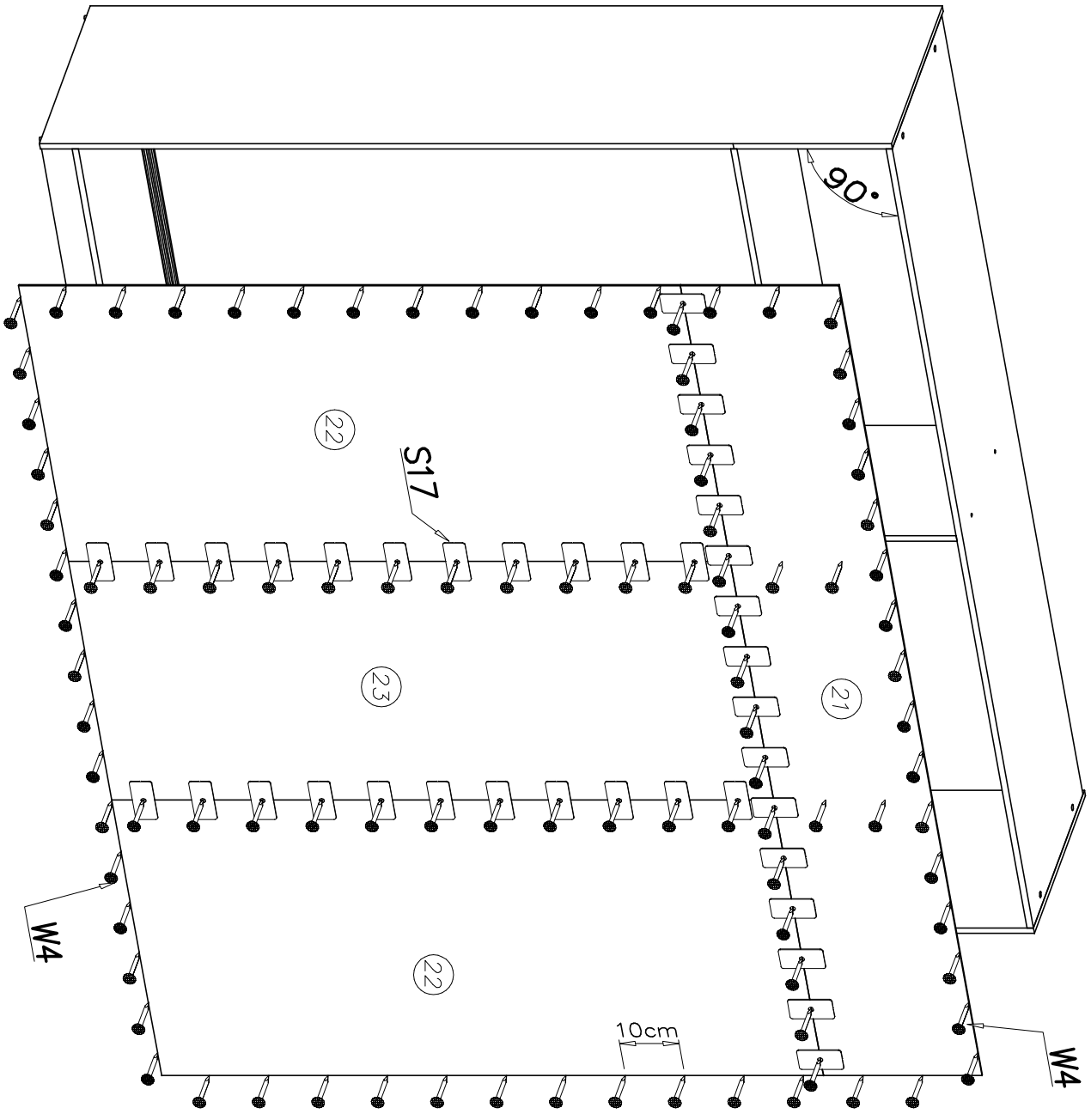

5

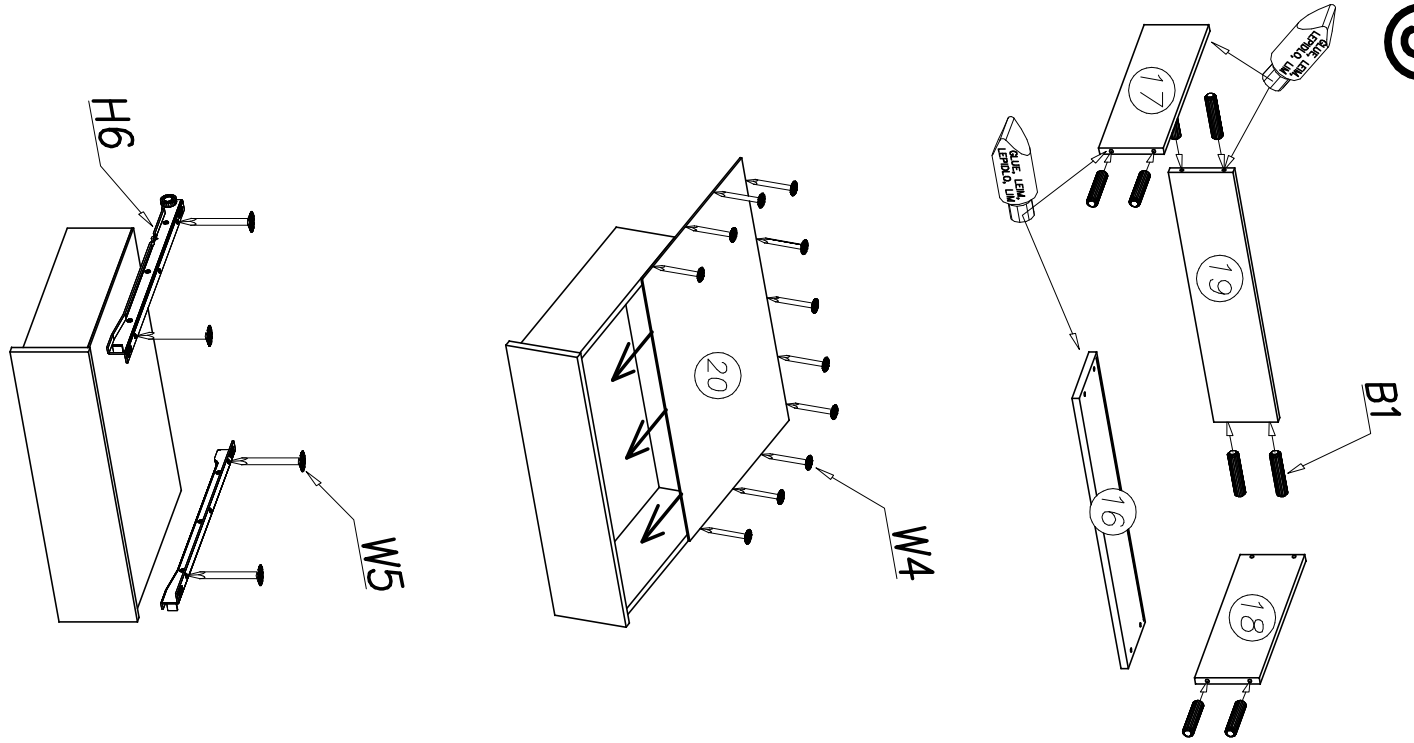

6

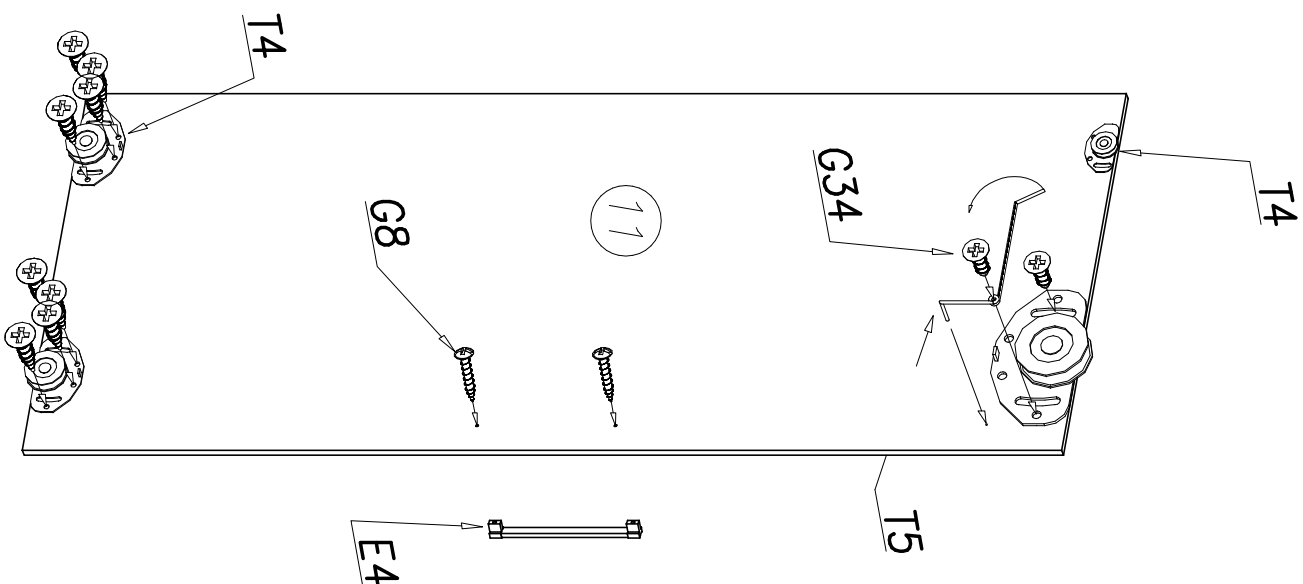
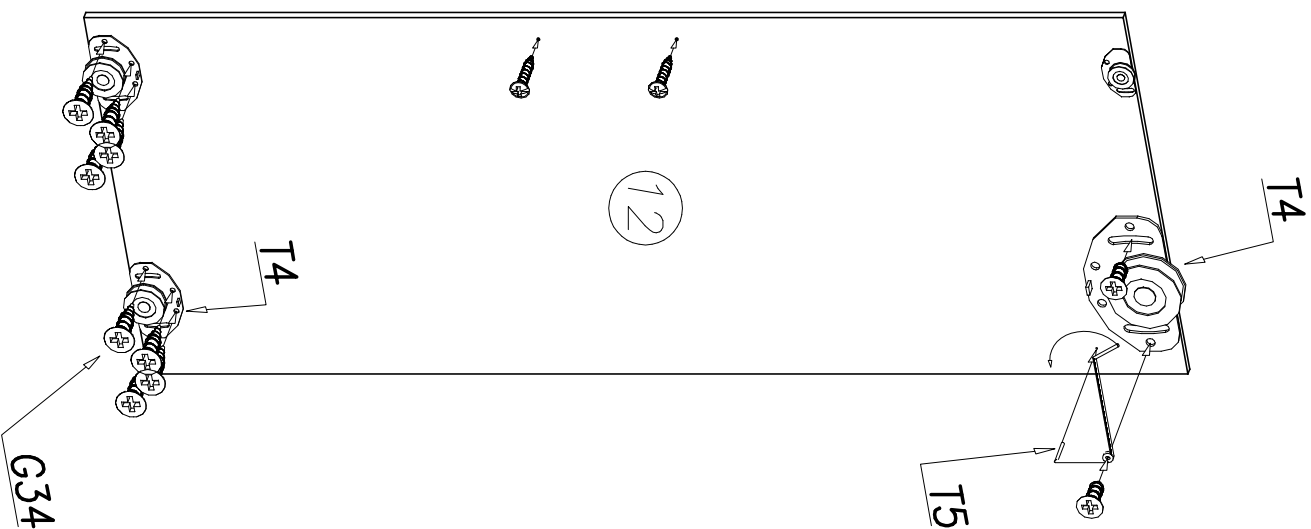
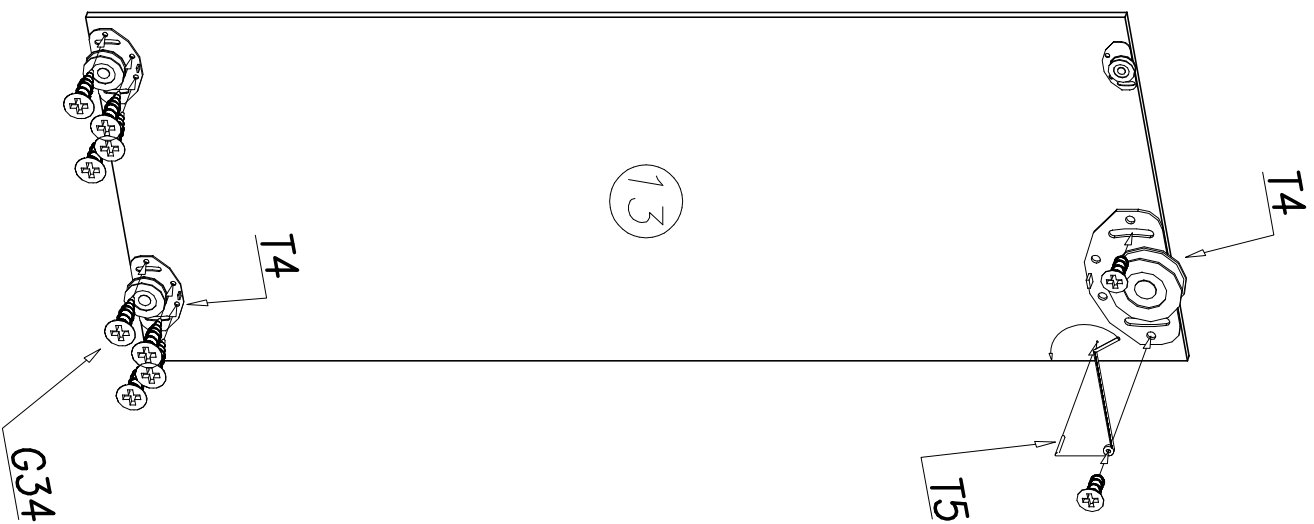

7

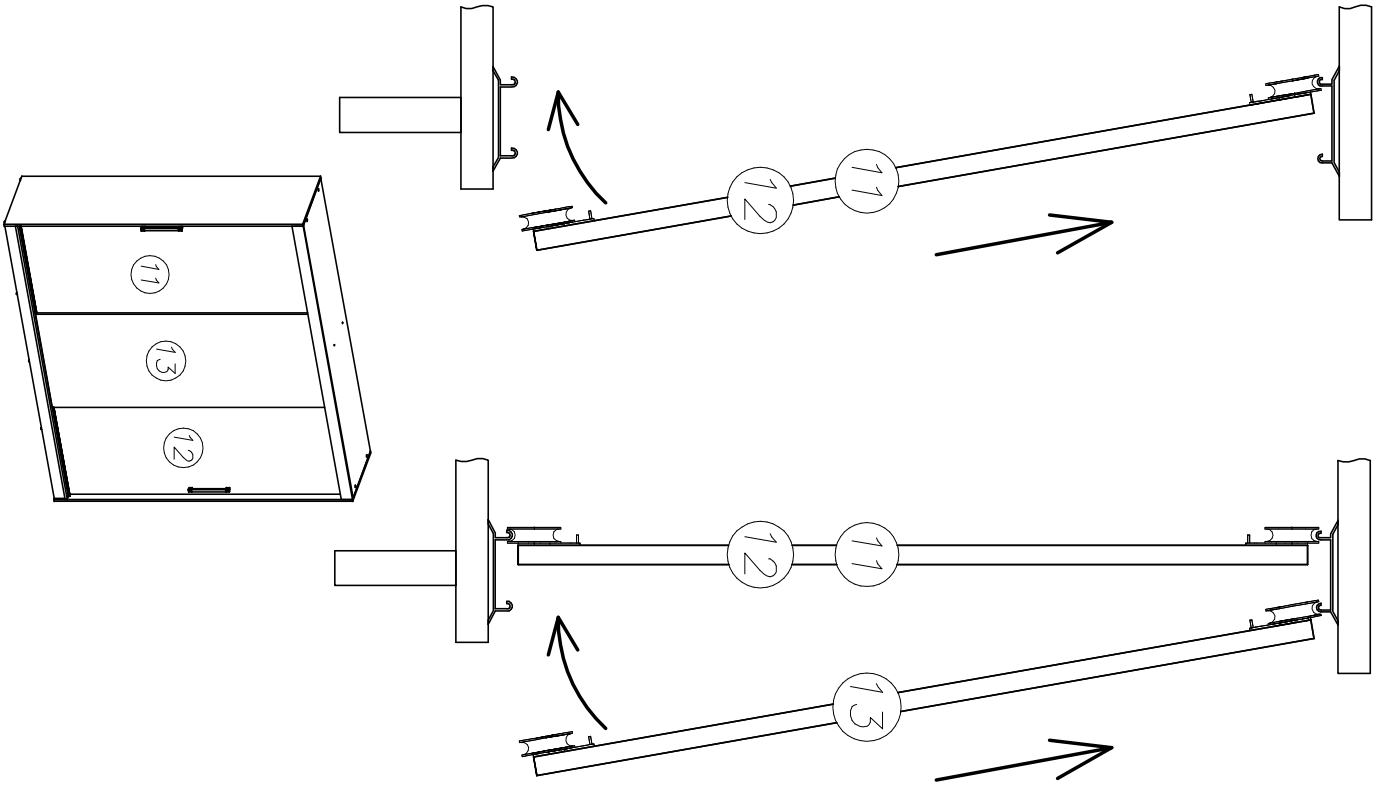

8

