

# PARVIN

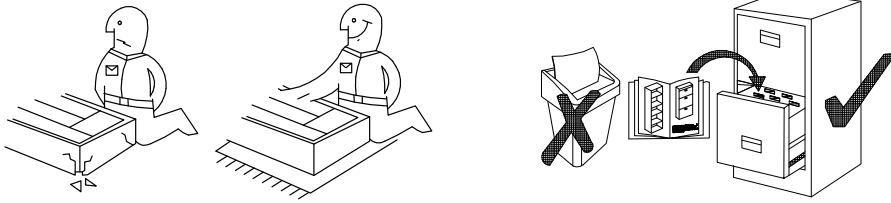

WH3F3S   
SO3F3S

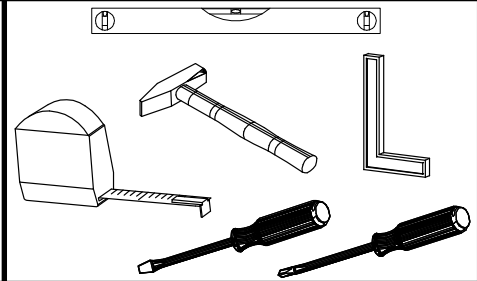
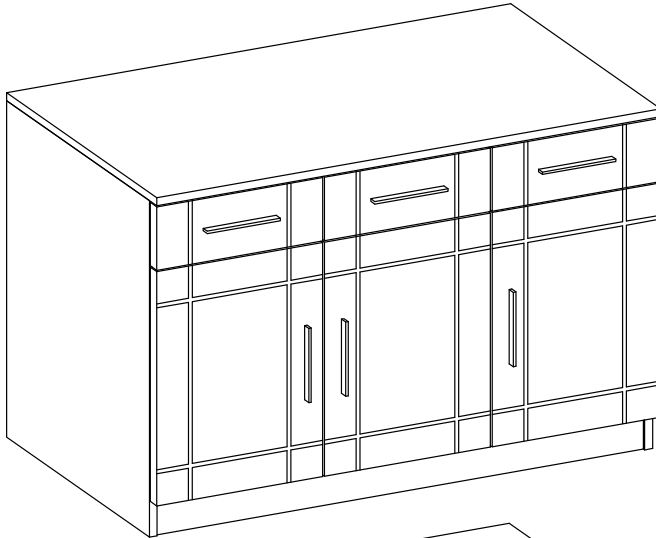

Coli	Ersatzteil Nummer	Dimension
1/2	PAS.7A7 x3	473x340x16
	PAS.7A8 x3	340x128x16
Coli	Ersatzteil Nummer	Dimension
2/2	PAS.107	680x352x16
	PAS.108	680x352x16
	PAS.202	1034x370x16
	PAS.304 x2	319x315x16
	PAS.305	327x315x16
	PAS.408	1000x329x16
	PAS.508 x2	594x329x16
	PAS.607 x2	614x332x2,5
	PAS.608	614x342x2,5
	PAS.609 x3	296x289x2,5
	PAS.909 x3	300x100x12
	PAS.910 x3	300x100x12
PAS.911 x3	279x100x12	
PAS.912	1000x70x16	

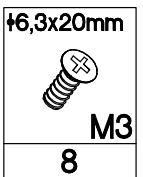
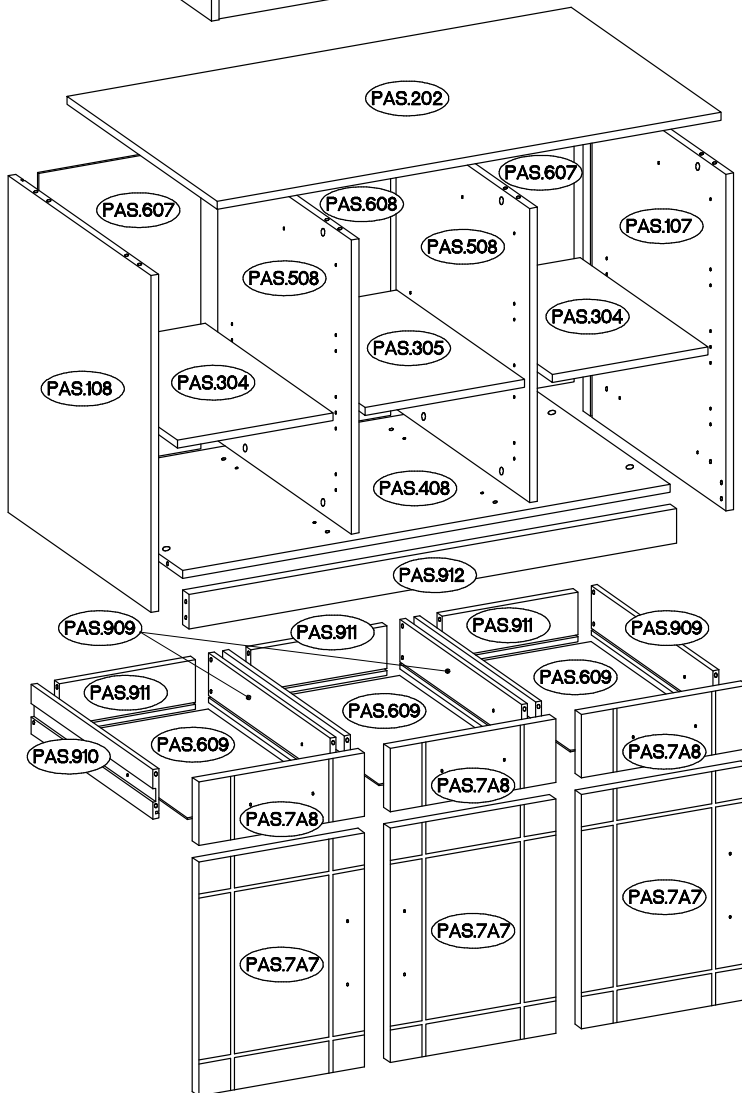

+20/8mm J14	 L9	+10x50mm O7	0,05 Leth O11	 J3
8	1 L=128mm	1 +6,3x13mm	1 27/214mm	12 +6x42mm
L	S11	M2	I3	B2
7	6	4	3	6
 L2	+4.0x30mm R2	+3.5x13mm P5	+15x5mm F4	6.5x48x16 F2
8	12 H=2	13 +35/9mm	2 +35/0mm	4 H=0
 P7	H4	G1	G	H
17 M4x9mm	2 +15/12mm	2 +8x30mm	4 L=20mm	4
 U1	C	A	D2	E
6	16	38	16	8

ISM-PAS-05

1

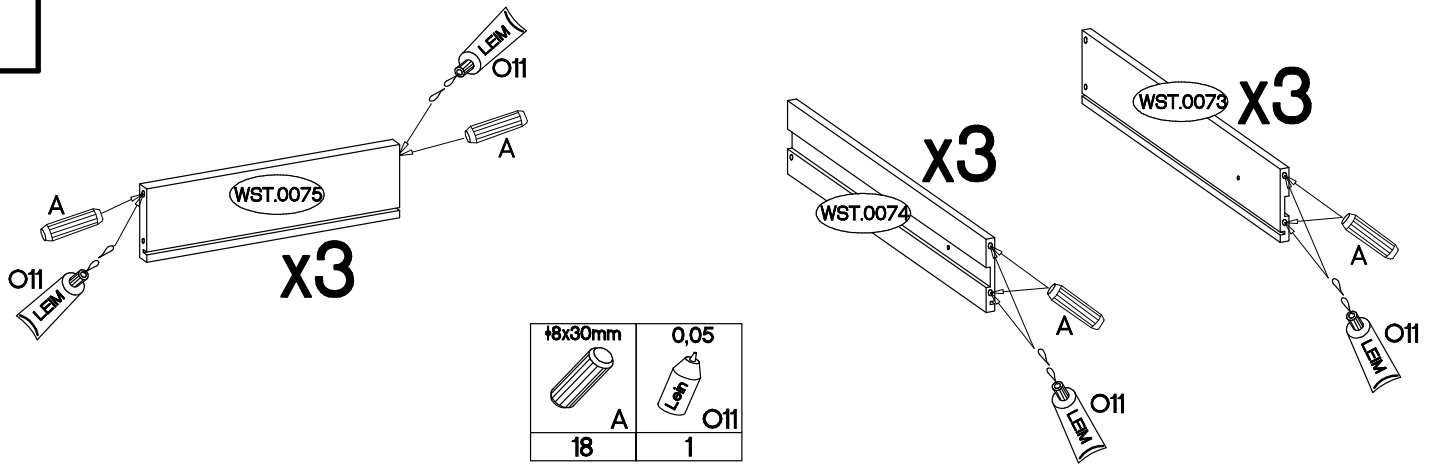



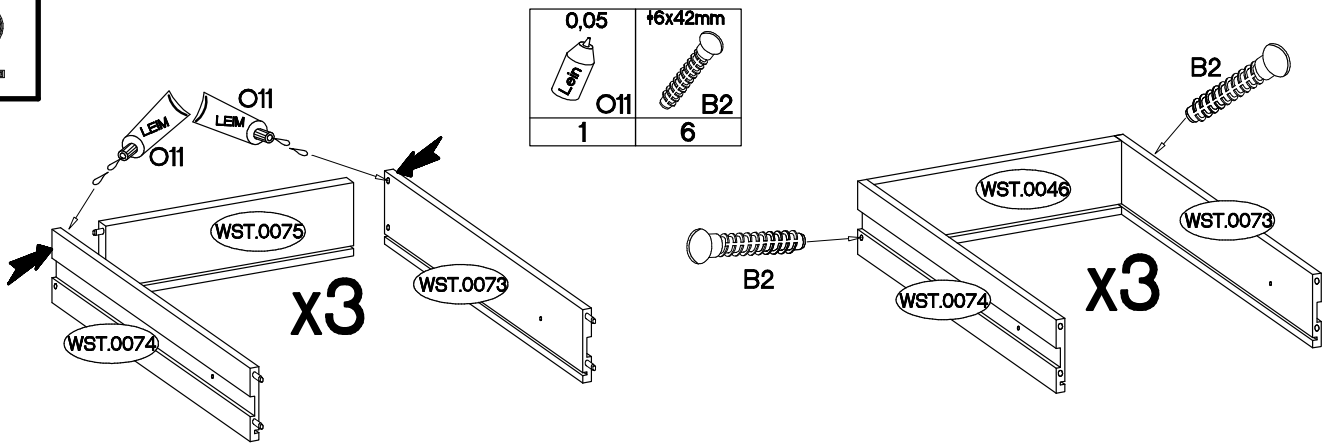



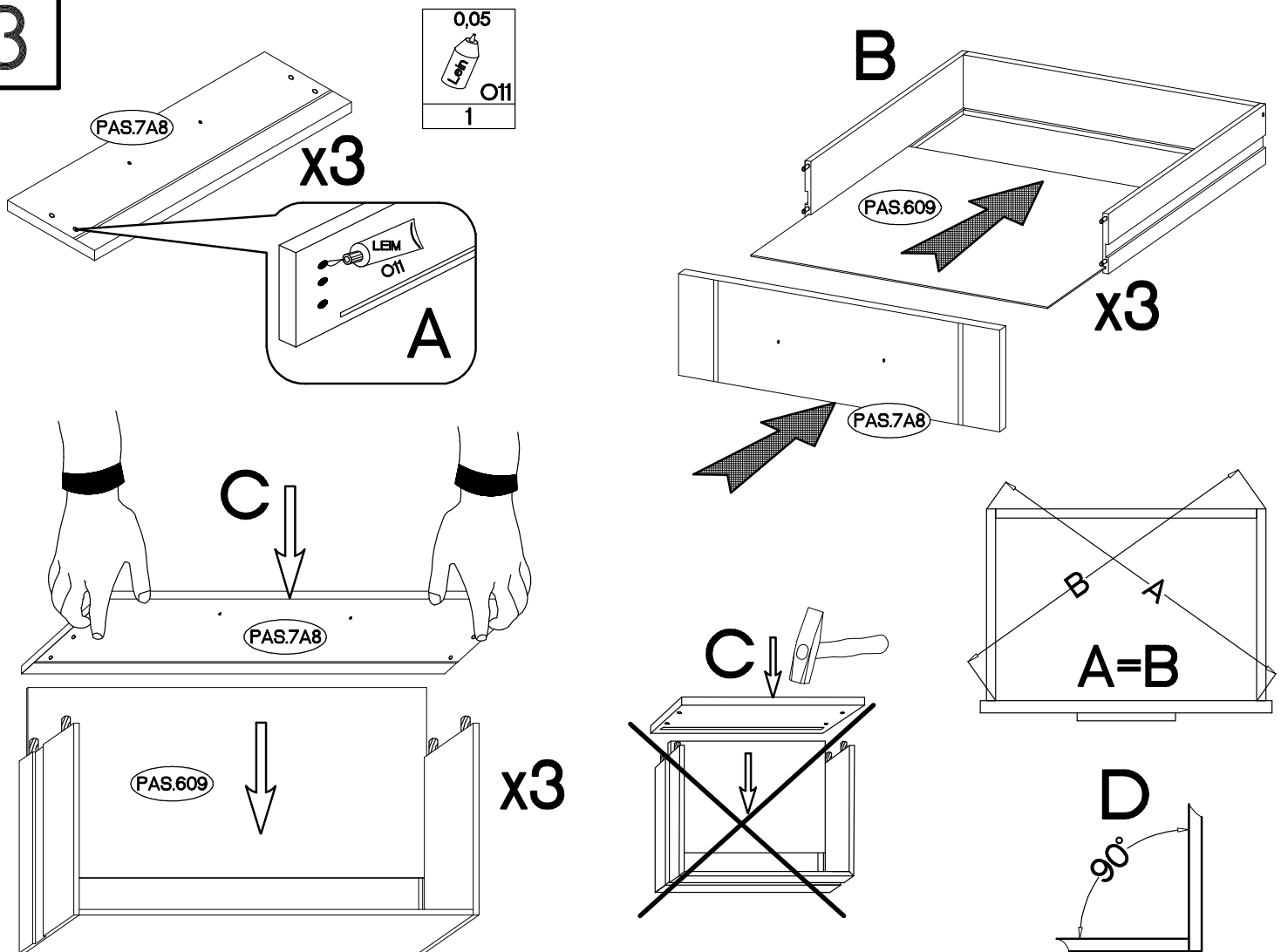

2



3



$\pm 15/12\text{mm}$  C 16	$\pm 8 \times 30\text{mm}$  A 20	L=20mm  D2 16	$\pm 15 \times 5\text{mm}$  F4 2	6.5x48x16  F2 4	$\pm 6,3 \times 13\text{mm}$  M2 4	27/214mm  I3 3	$\pm 6,3 \times 20\text{mm}$  M3 8	$\pm 20/8\text{mm}$  J14 8
---	---	--	---	--	---	--	---	---

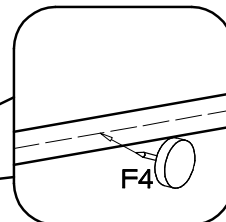
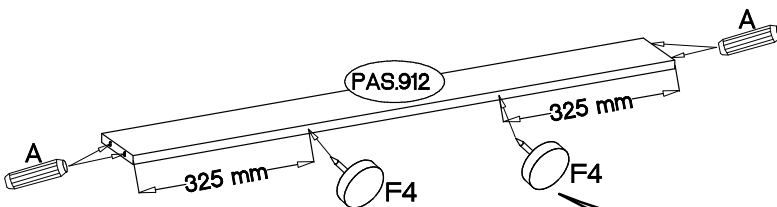
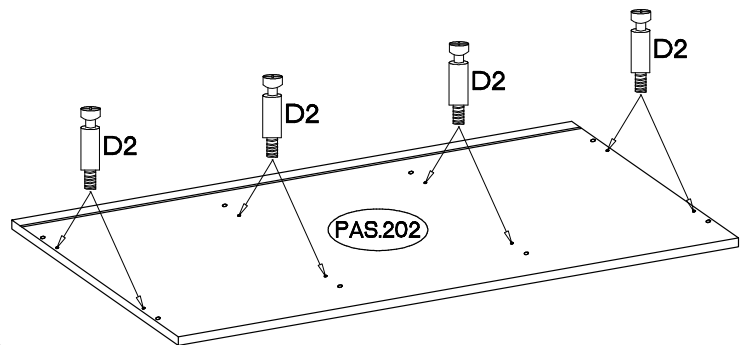
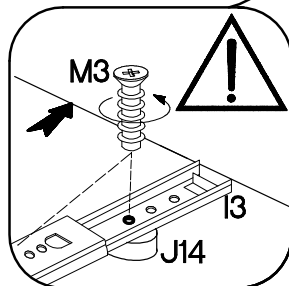
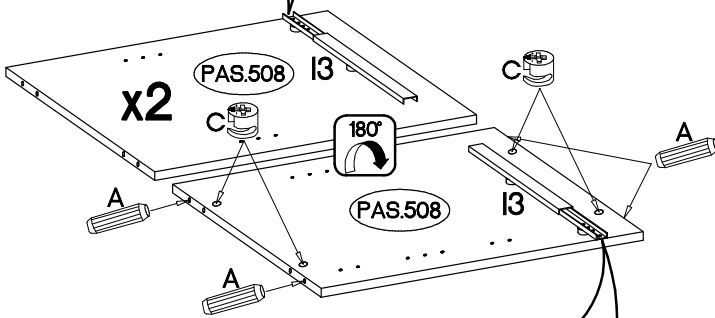
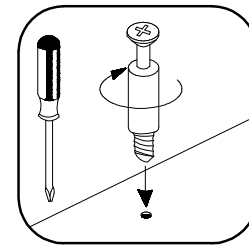
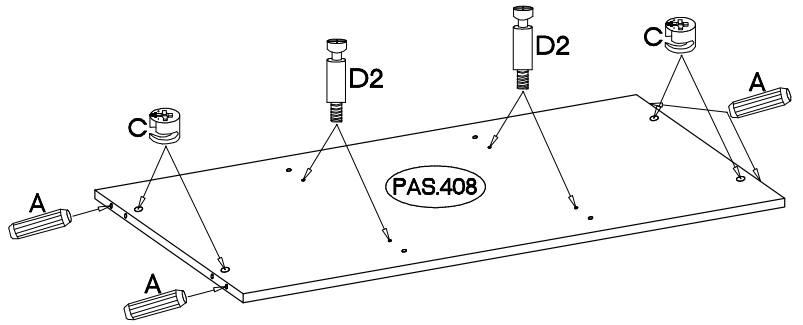
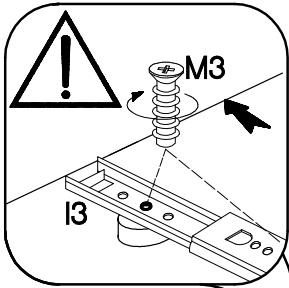
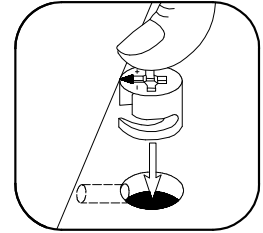
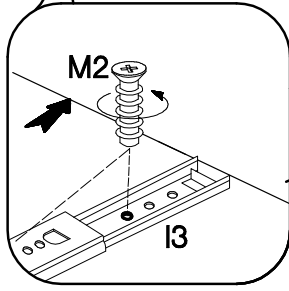
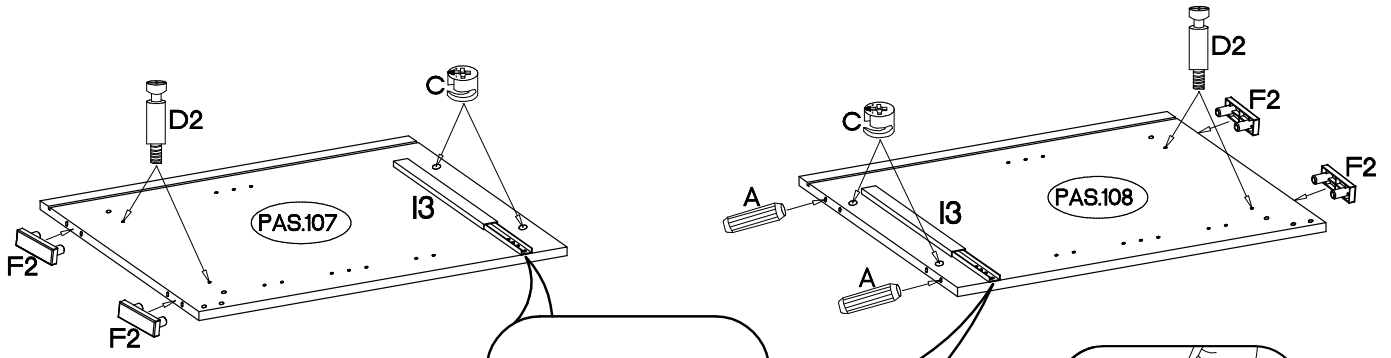

5

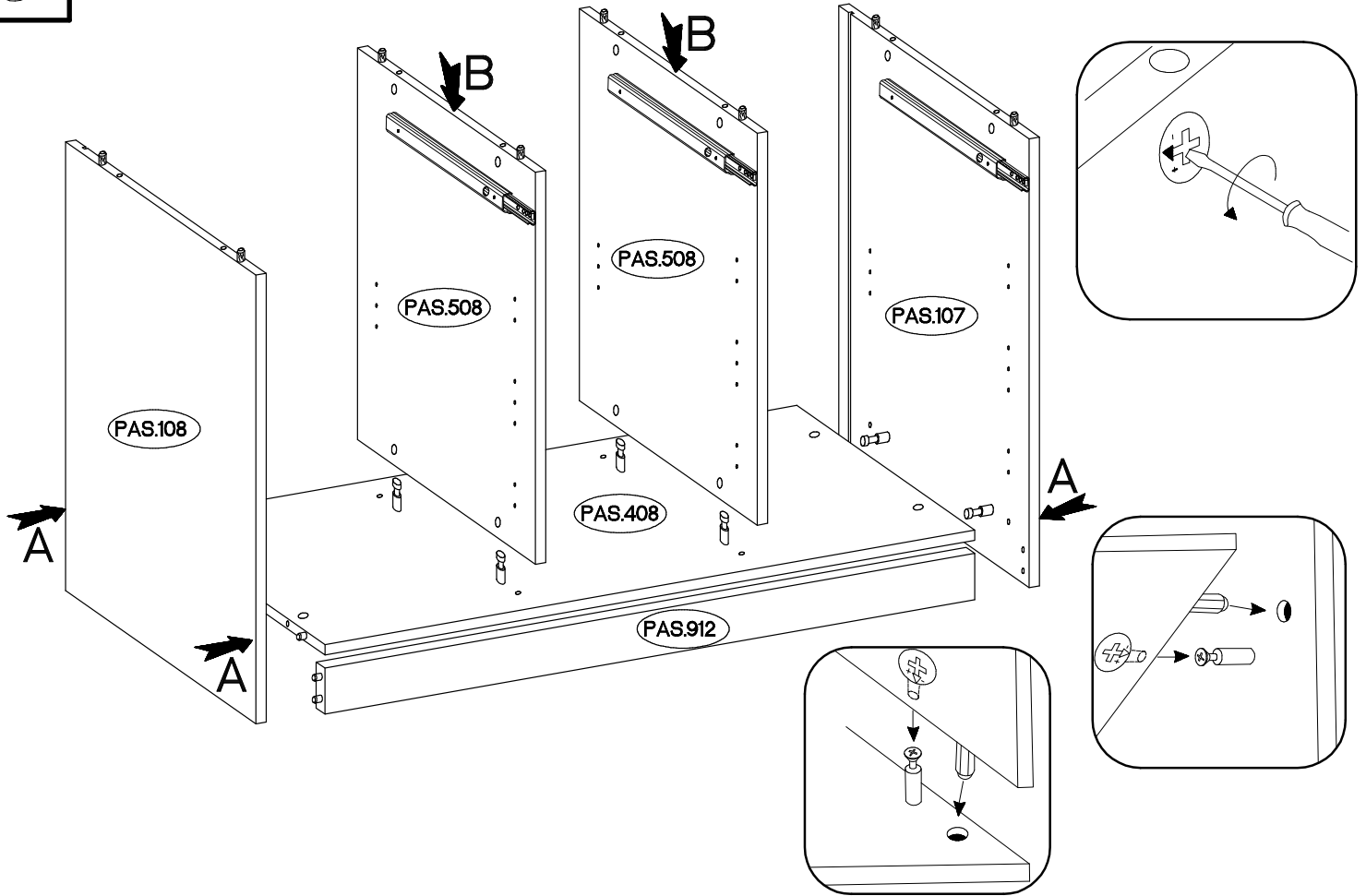

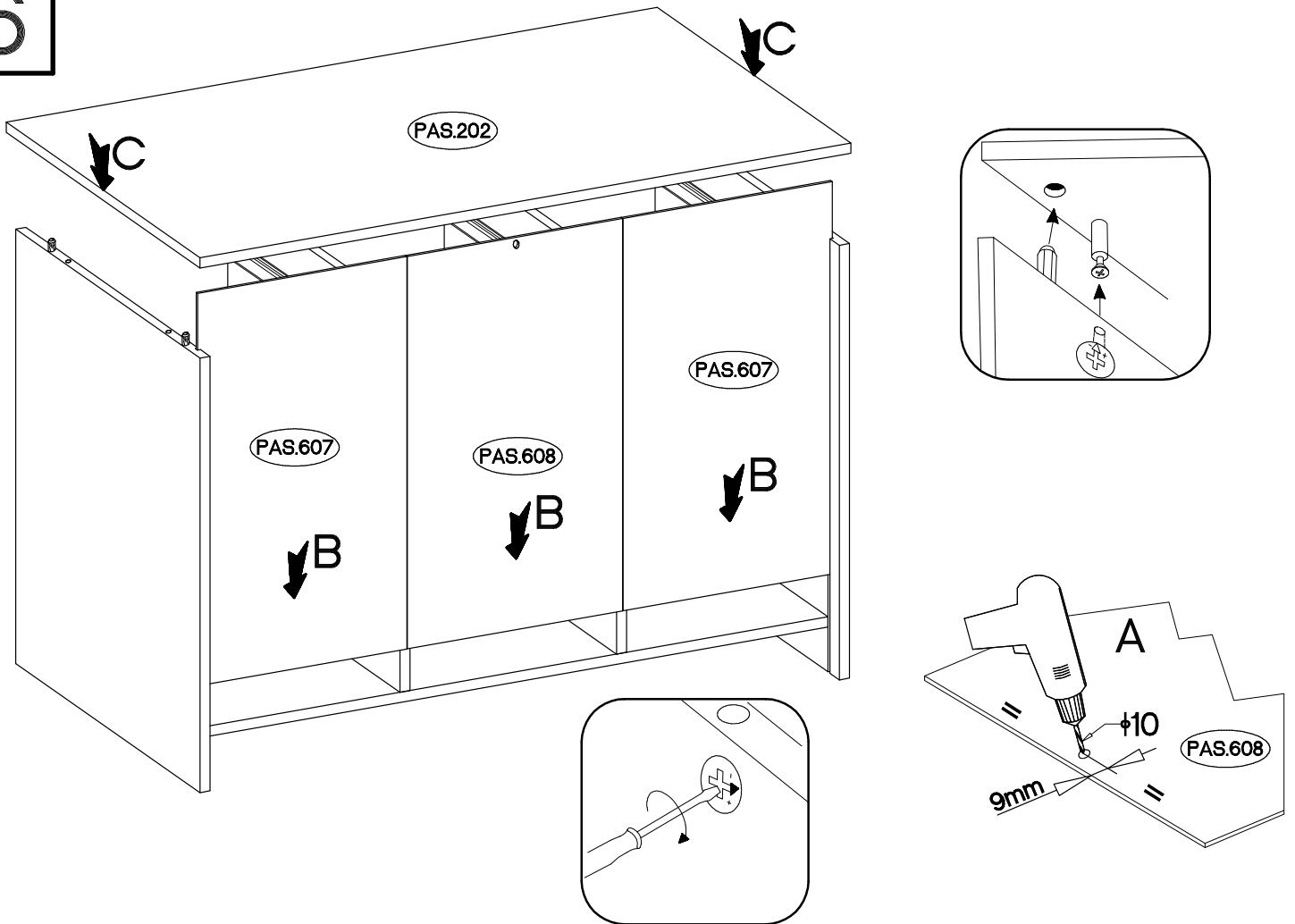

6



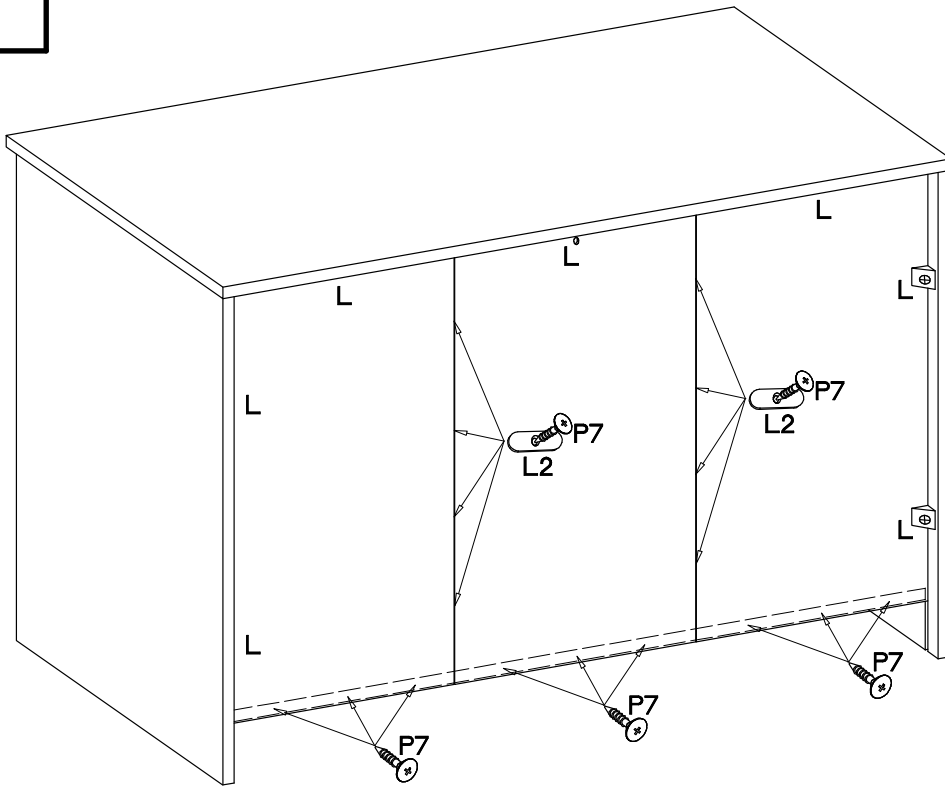

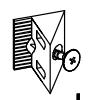
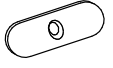

7

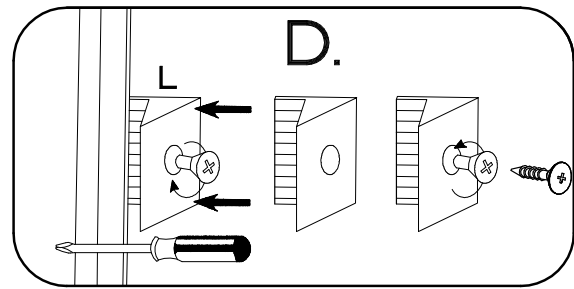
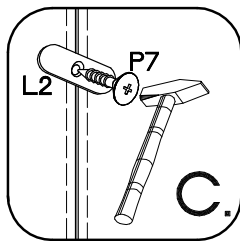
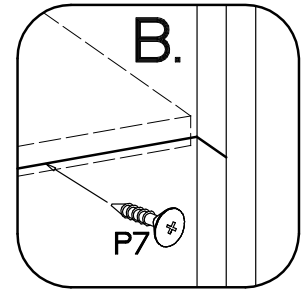
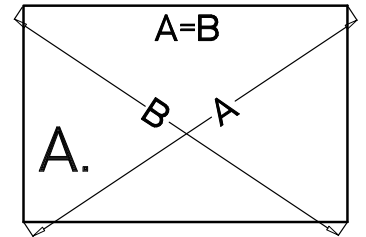

		
L	L2	P7
7	8	17



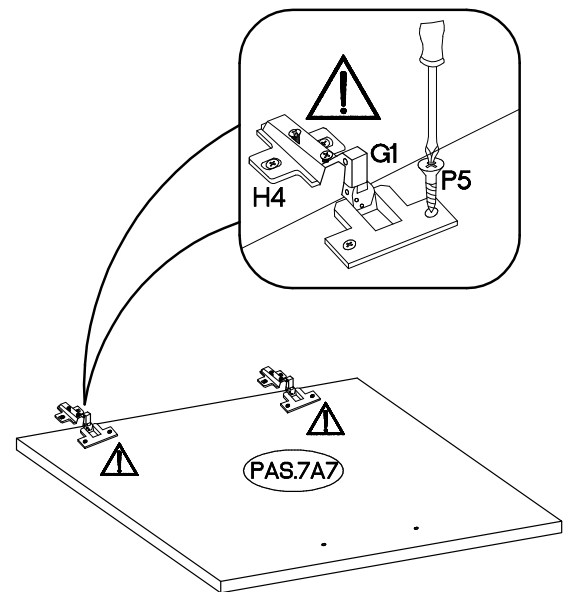
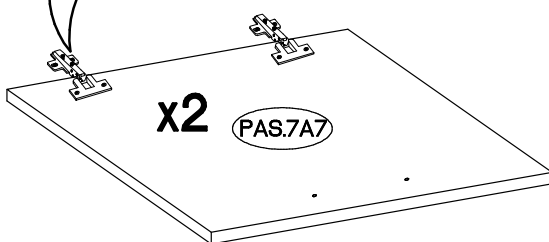
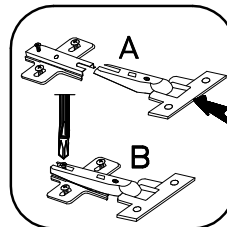
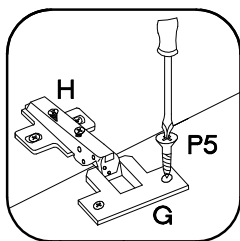

8

				
P5	H4	G1	G	H
12	2	2	4	4



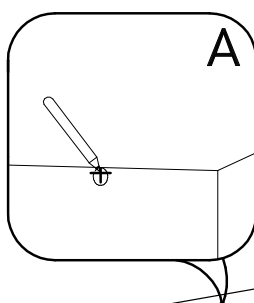

9

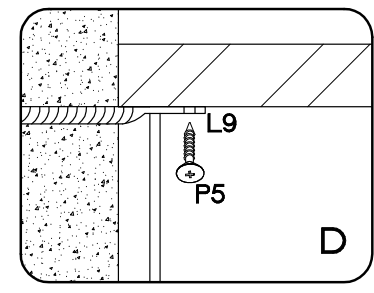
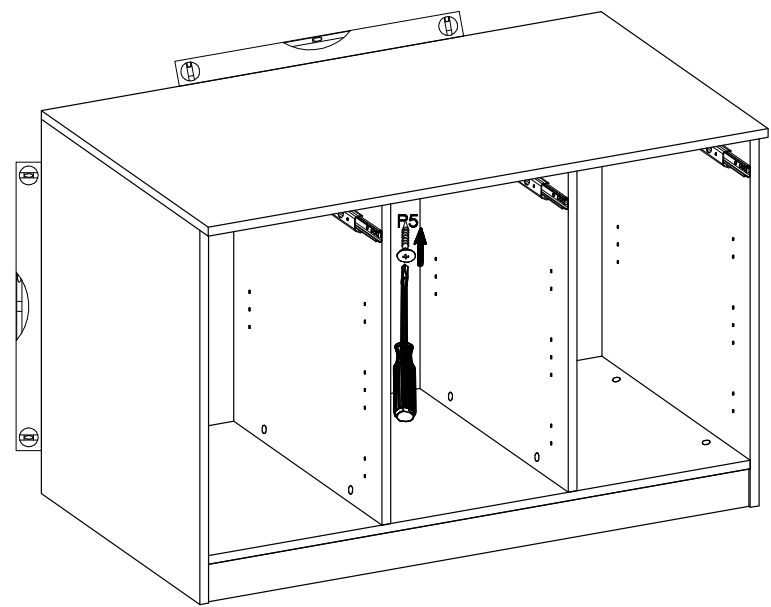
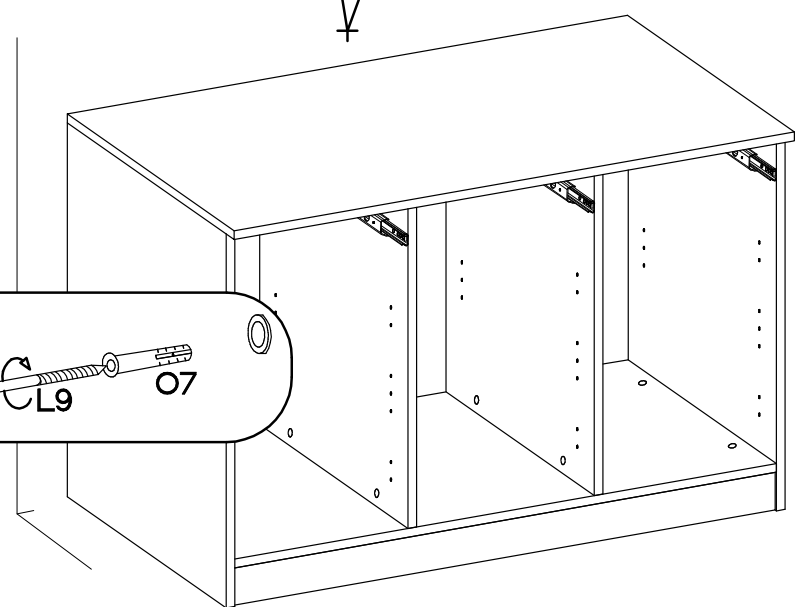
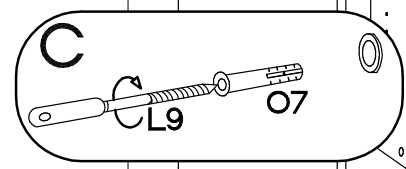
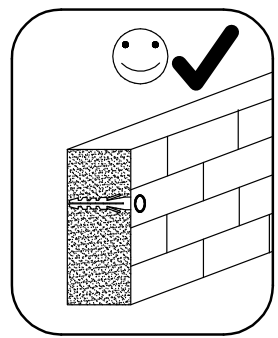
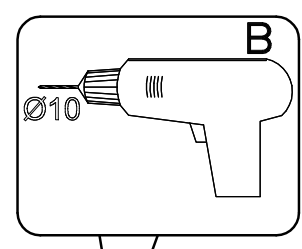
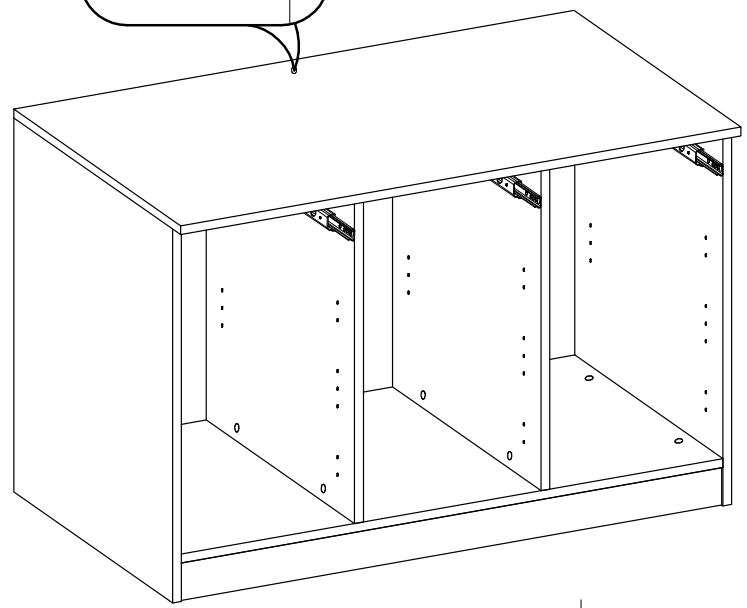
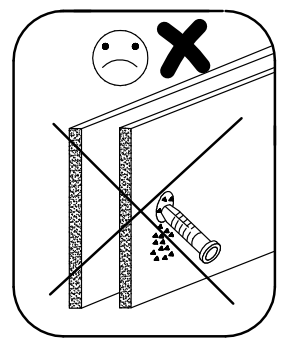

	$\pm 10 \times 50 \text{mm}$	$\pm 3.5 \times 13 \text{mm}$
L9	O7	P5
1	1	1



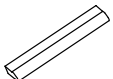

10

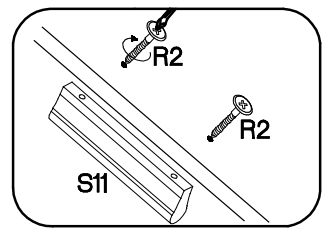
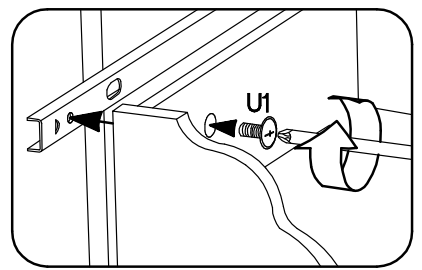
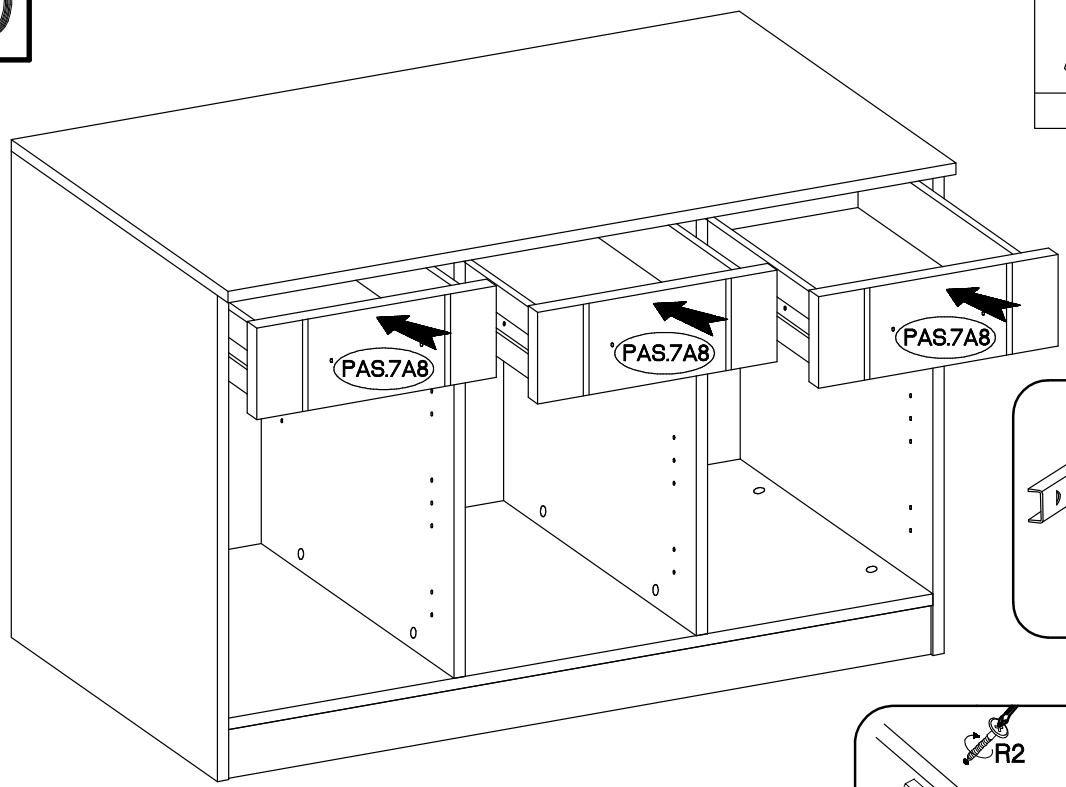
+4.0x30mm  R2 6	L=128mm  S11 3	M4x9mm  U1 6
--	---	---



11

 J3 12	 E 8
---	---

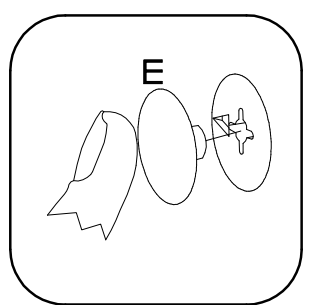
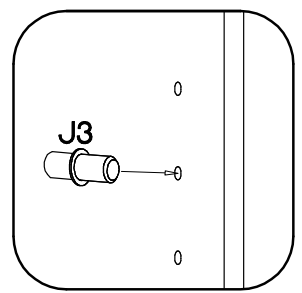
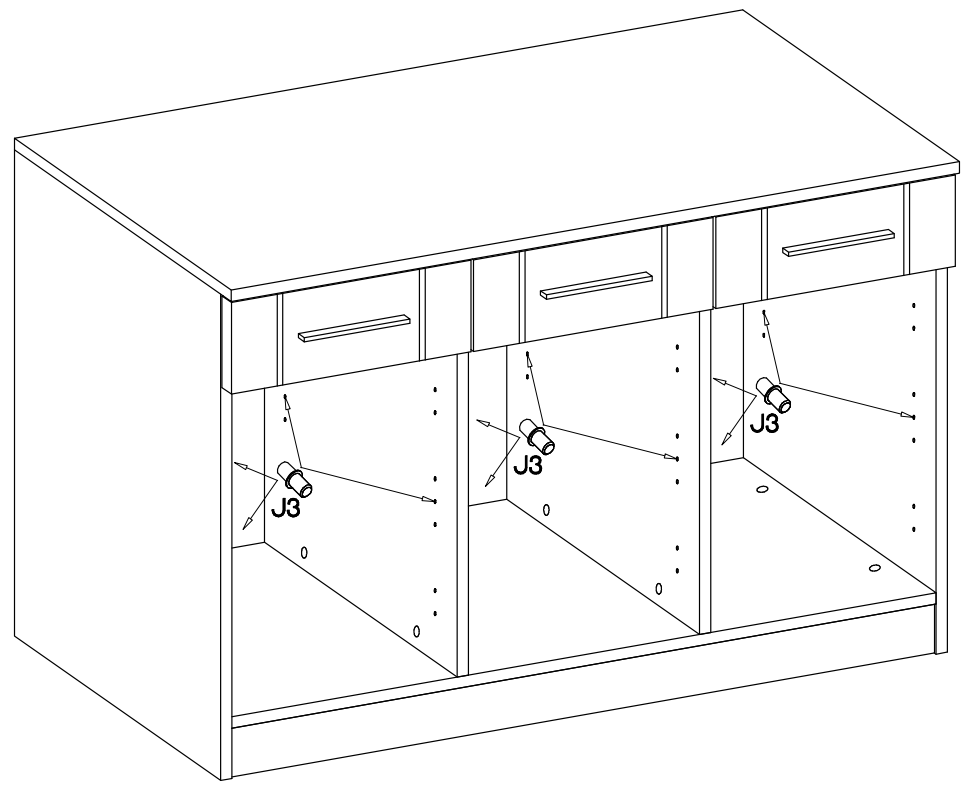

+4.0x30mm R2 6	L=128mm S11 3
----------------------	---------------------

