

# MORTEN

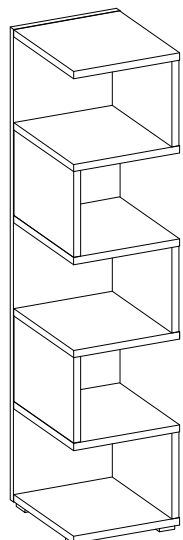

 <b>Ø10x50mm</b> <b>O7</b>	 <b>Ø5.0x70mm</b> <b>P29</b>	 <b>Ø20</b> <b>E11</b>
1	1	1

 <b>Ø8x30mm</b> <b>A</b>	 <b>6.4 x 50mm</b> <b>B</b>	 <b>Ø5/Ø8mm</b> <b>C6</b>	 <b>L=20mm</b> <b>D2</b>	 <b>E</b>	 <b>60x40x20</b> <b>F1</b>	 <b>Ø4.0x25mm</b> <b>P14</b>	 <b>O</b>
20	12	10	10	10	4	8	1

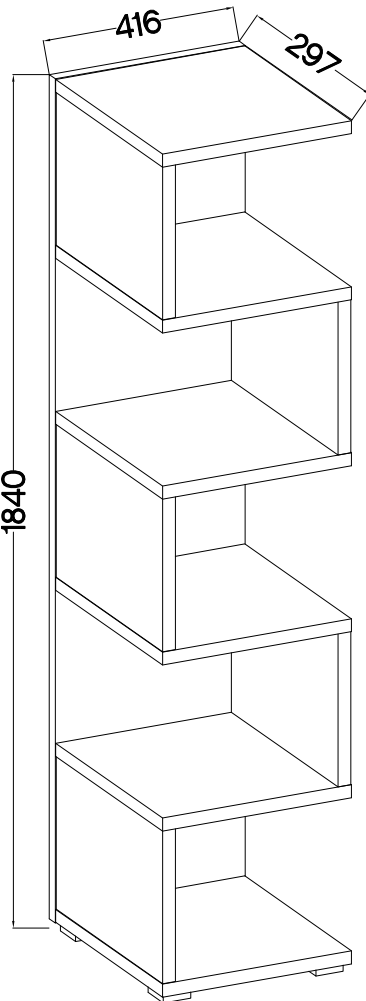
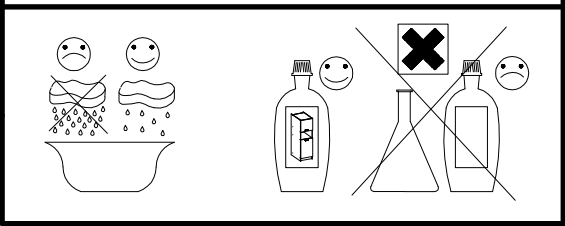
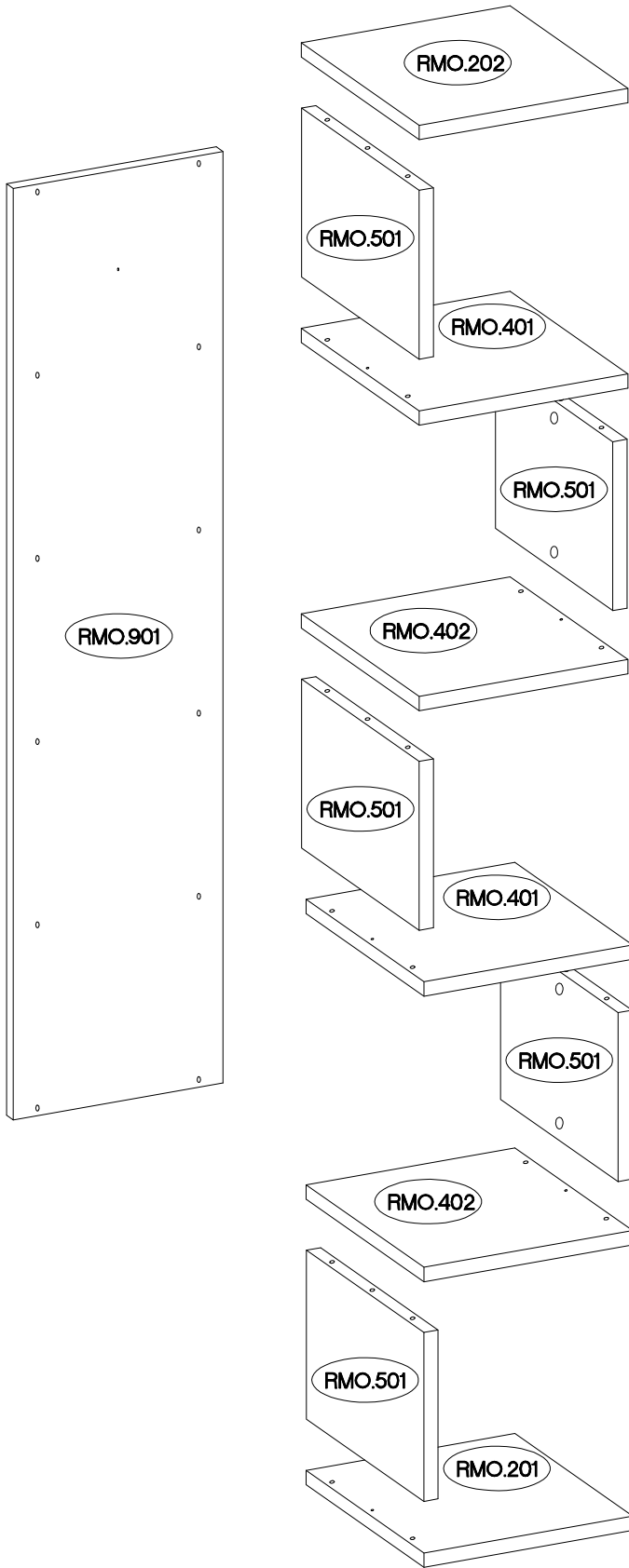

- RMO.201
- RMO.202
- RMO.401
- RMO.402

Colli	Ersatzteil Nummer	Dimension
Colli 1/1	RMO.201	414x281x28
	RMO.202	414x281x28
	RMO.401 x 2	414x281x28
	RMO.402 x 2	414x281x28
	RMO.501 x 5	330x280x28
	RMO.901	1820x416x16

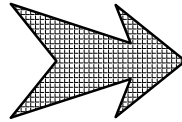
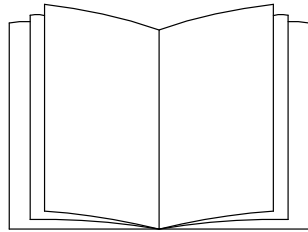
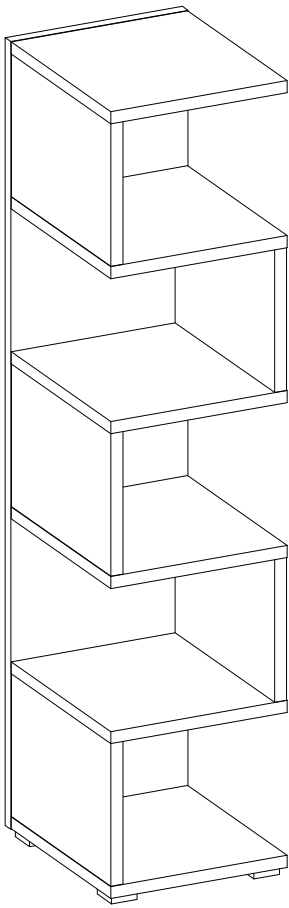

1 — 17

35

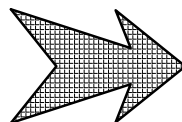
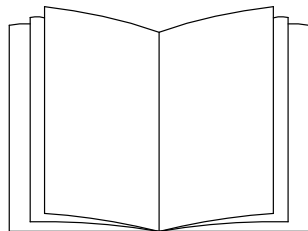
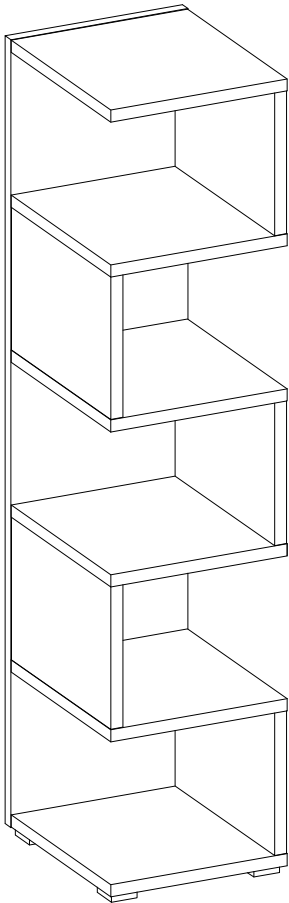



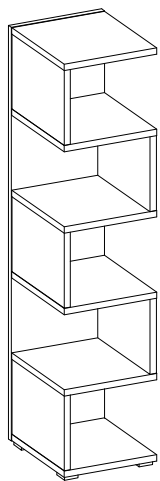

18 — 34

35

1

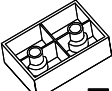

$\varnothing 8 \times 30 \text{mm}$  A	$\varnothing 15/18 \text{mm}$  C6	L=20mm  D2	60x40x20  F1	$\varnothing 4.0 \times 25 \text{mm}$  P14
20	10	10	4	8

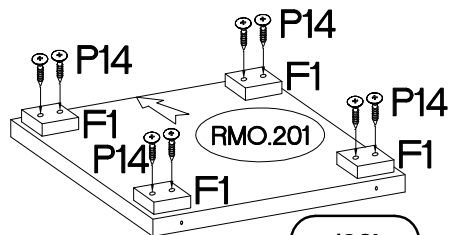
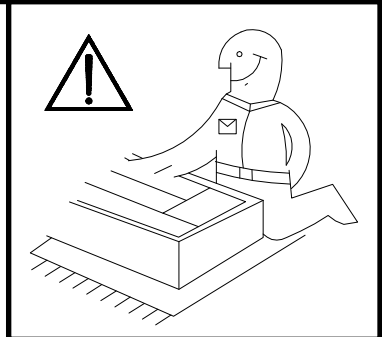

x1

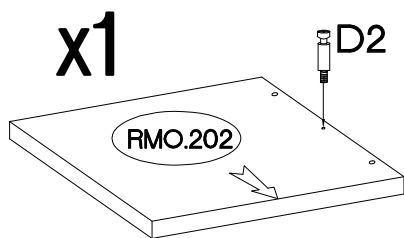
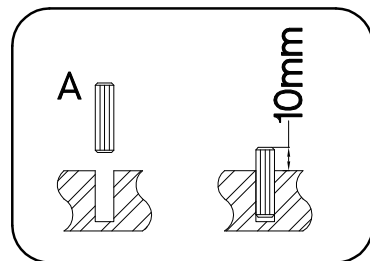
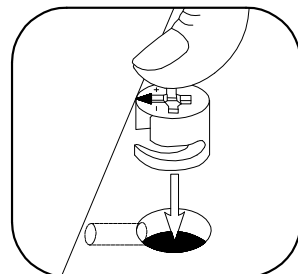
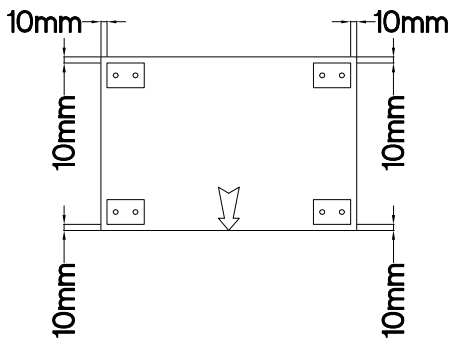
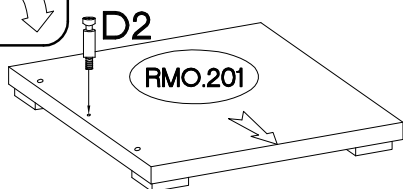
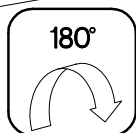

x1



x2

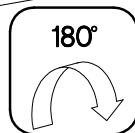

x2

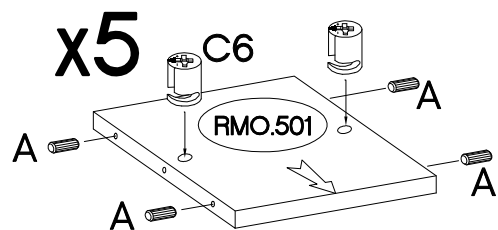
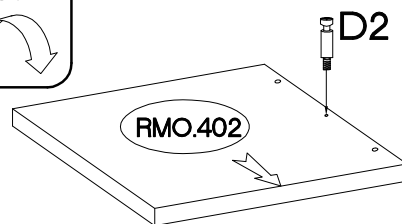
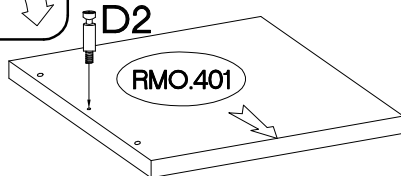
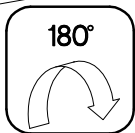

x5

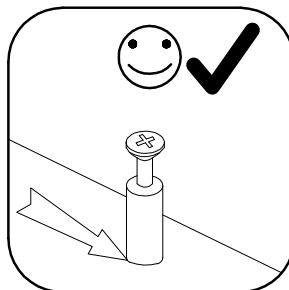
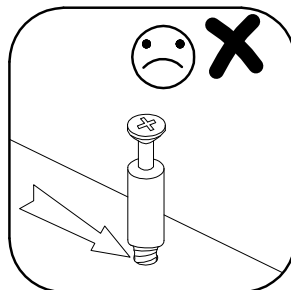
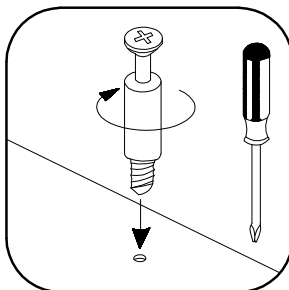



2

6,4 x 50mm

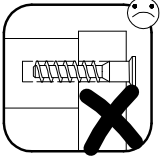
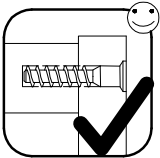
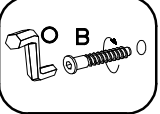
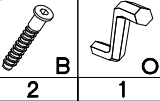

RMO.901

RMO.201

B

B

3

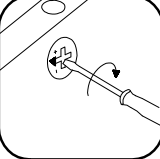
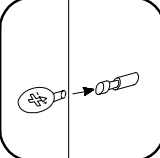
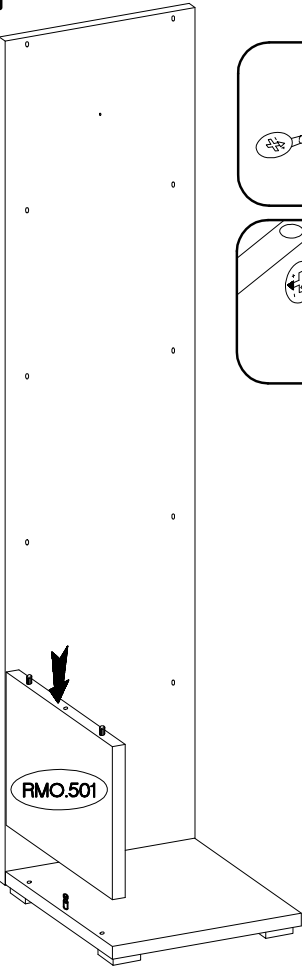

4

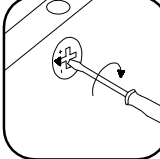
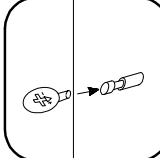
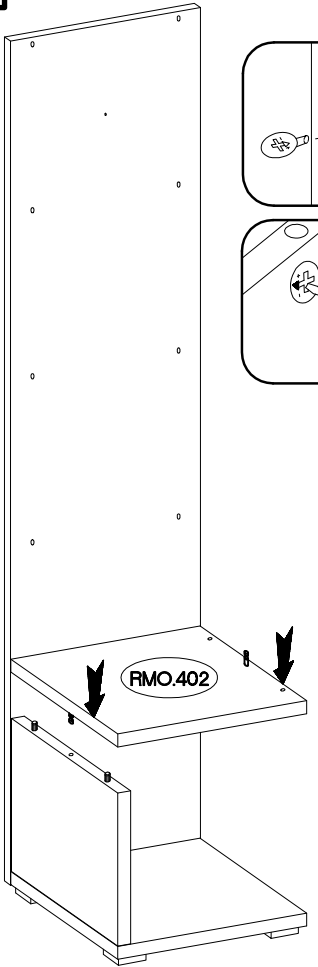

5

6,4 x 50mm

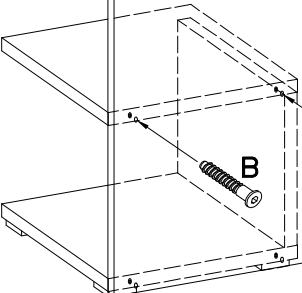
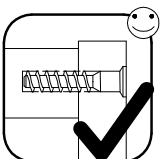
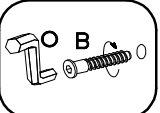
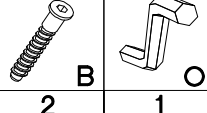

B

B

6

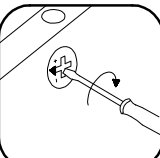
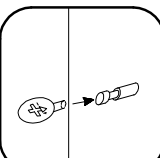
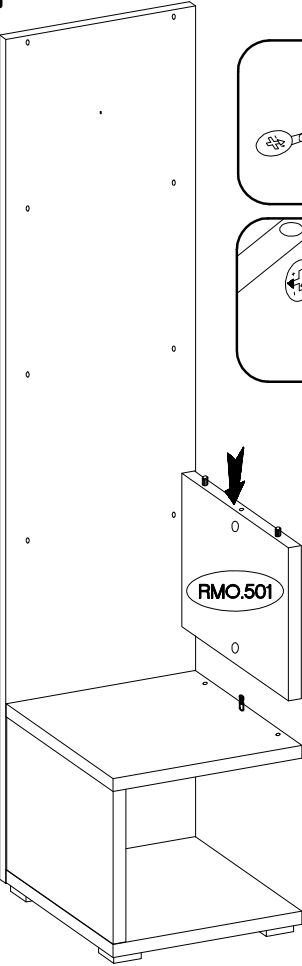

7

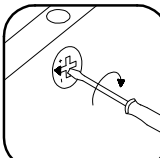
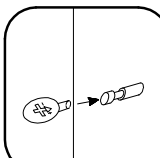
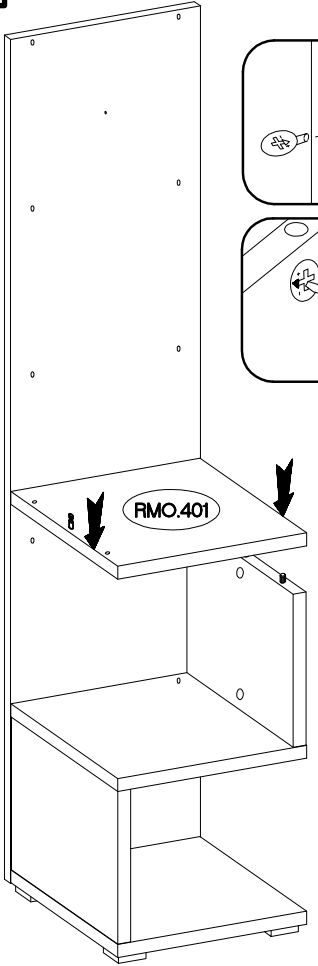

8

6,4 x 50mm



B



O

2

1

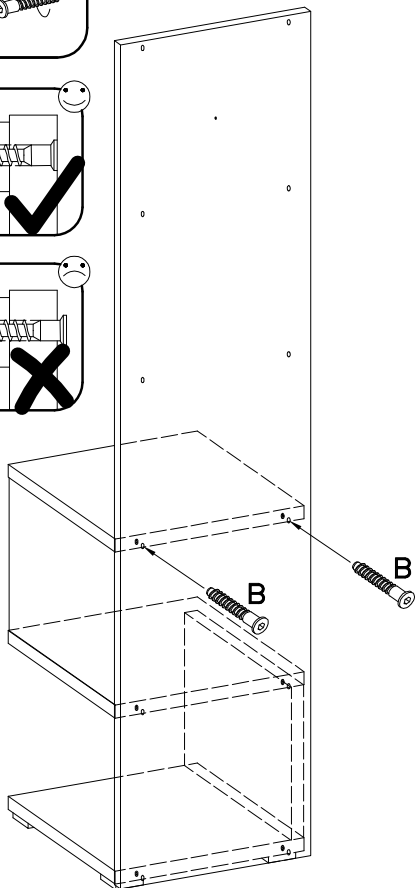
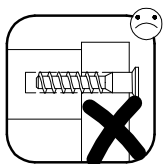
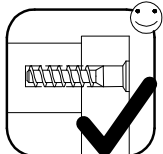
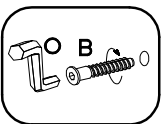

9

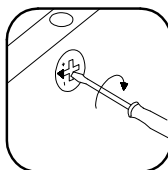
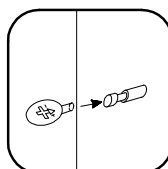
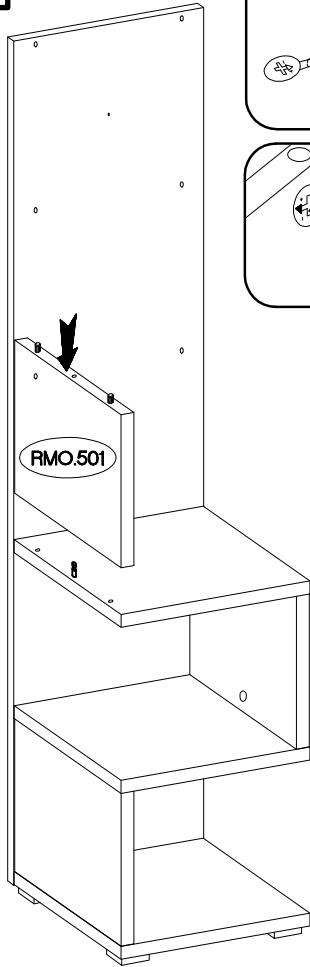

10

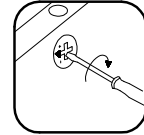
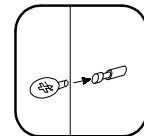
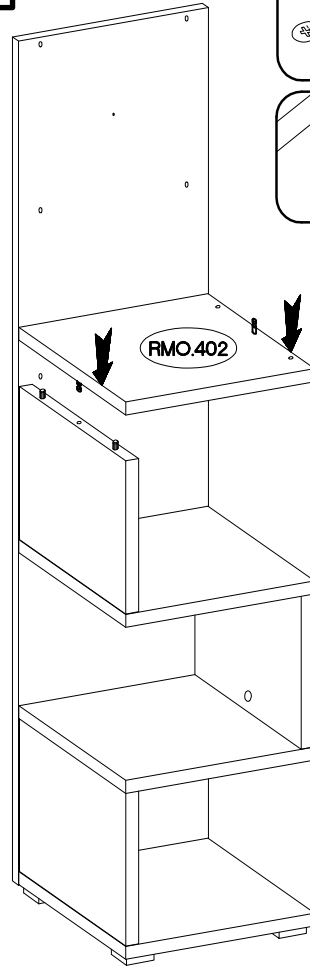

11

6,4 x 50mm



B



O

2

1

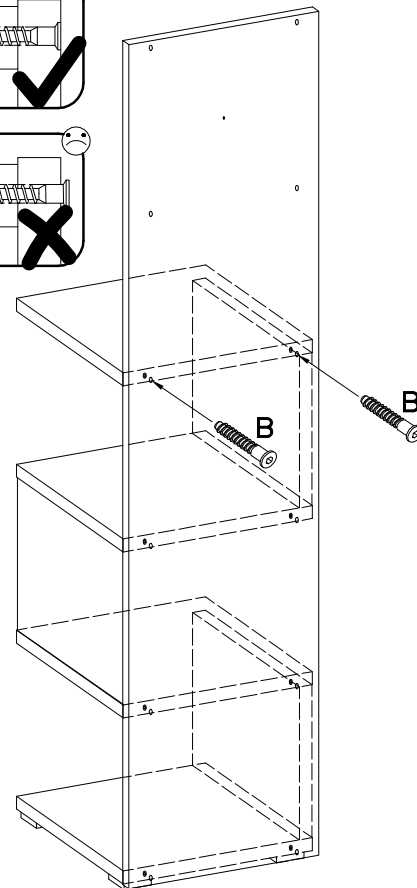
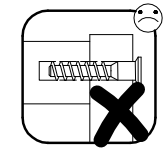
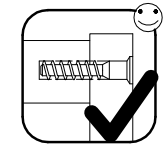
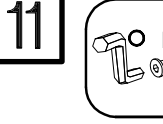

12

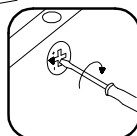
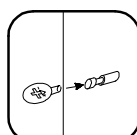
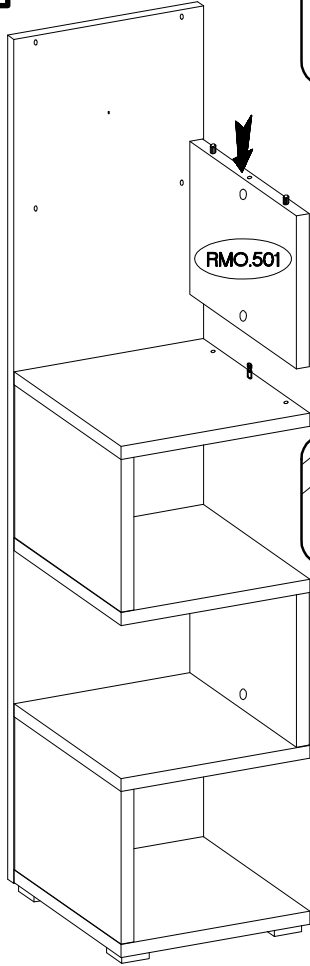

13

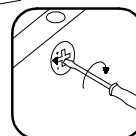
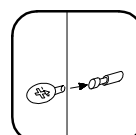
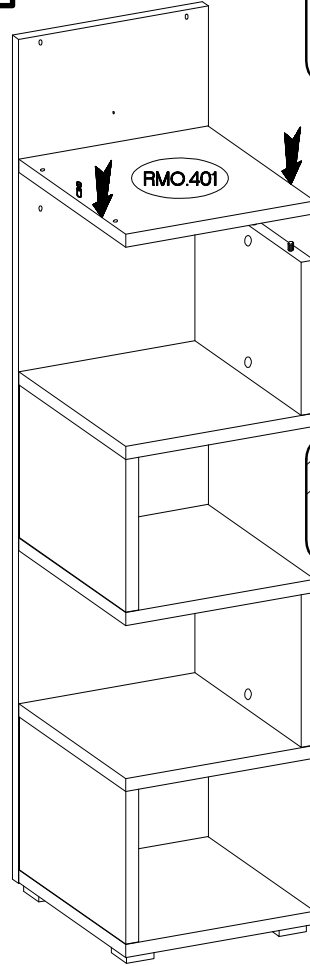

14

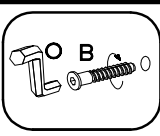

6,4 x 50mm

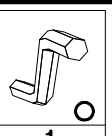
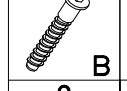

2

1

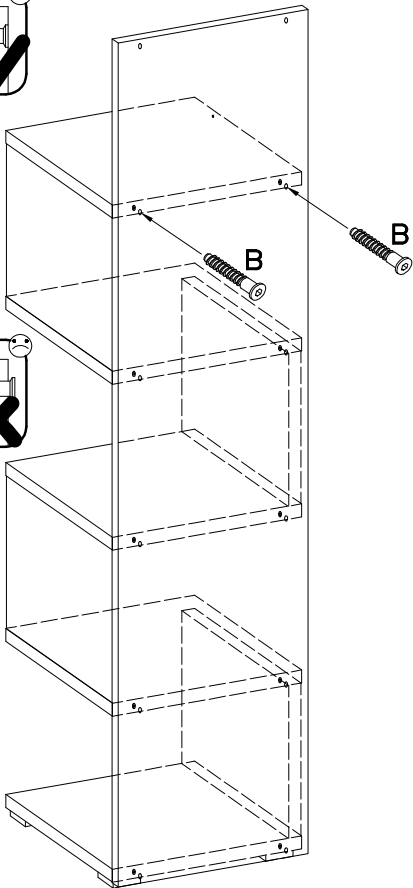
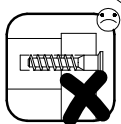

15

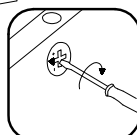
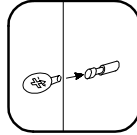
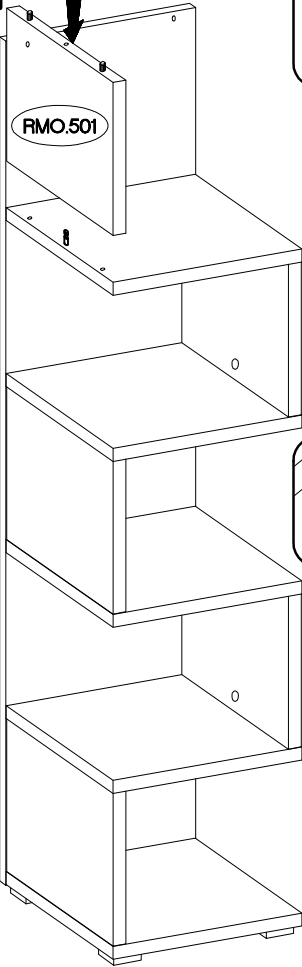

16

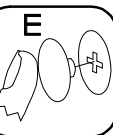
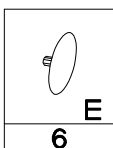
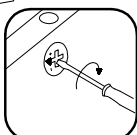
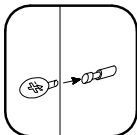
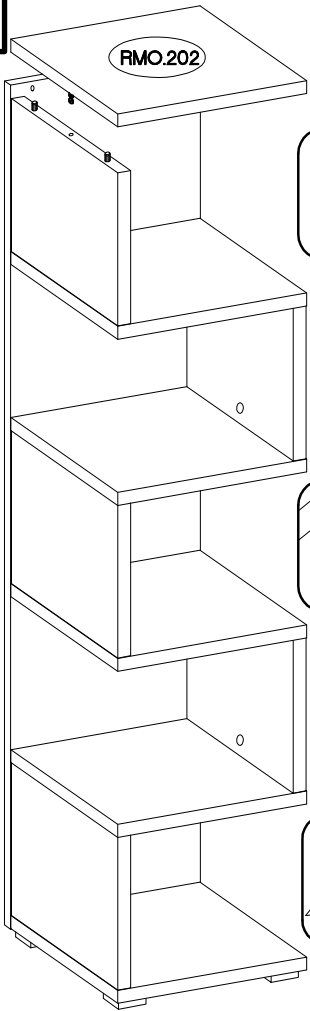

17

6,4 x 50mm

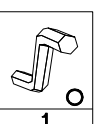
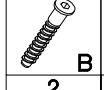

2

1

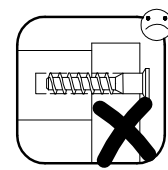
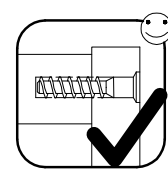
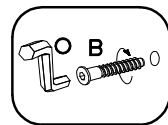
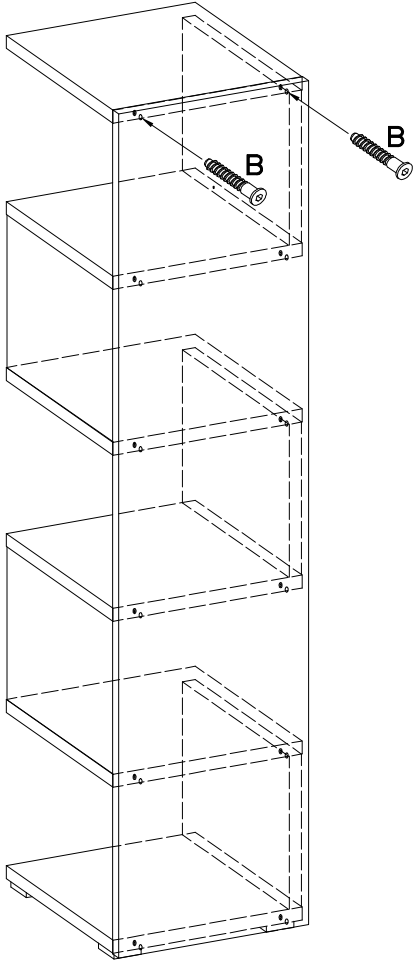

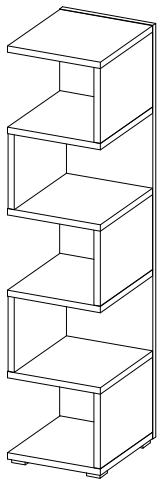

$\varnothing 8 \times 30 \text{mm}$  <b>A</b> 20	$\varnothing 15/18 \text{mm}$  <b>C6</b> 10	$L=20 \text{mm}$  <b>D2</b> 10	$60 \times 40 \times 20$  <b>F1</b> 4	$\varnothing 4.0 \times 25 \text{mm}$  <b>P14</b> 8
---	--	---	--	--

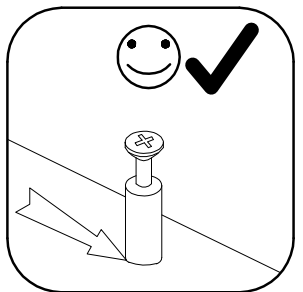
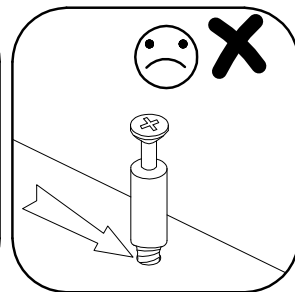
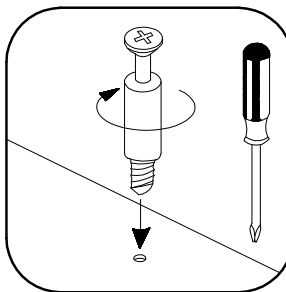
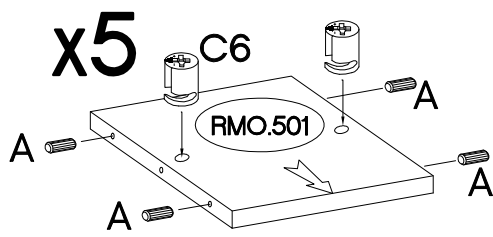
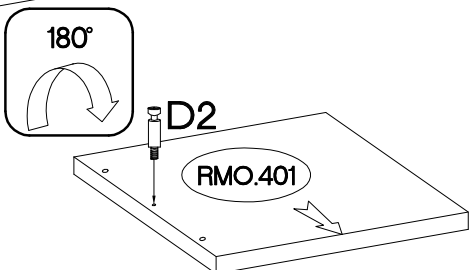
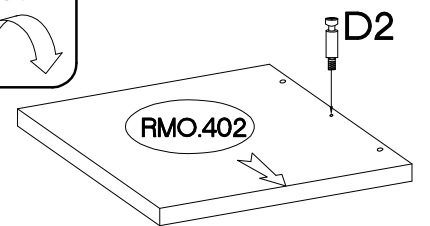
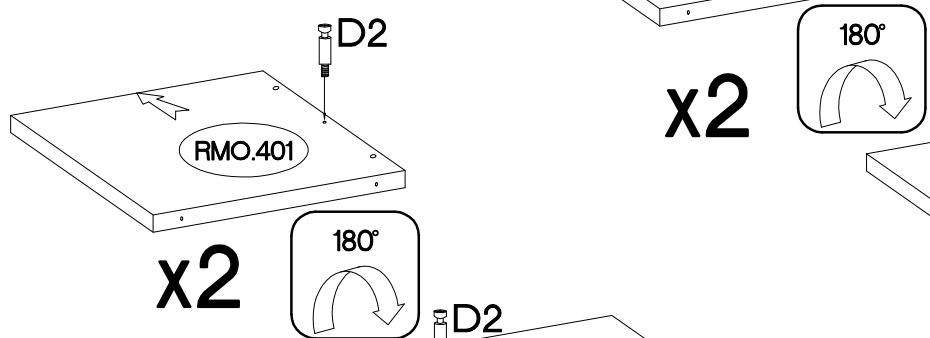
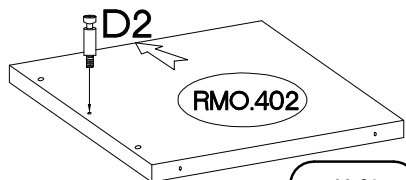
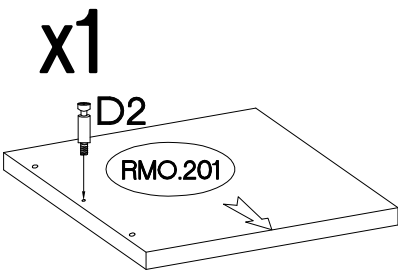
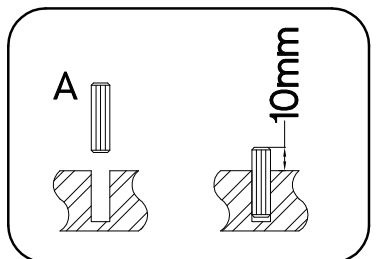
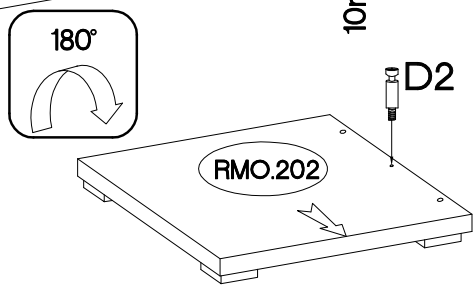
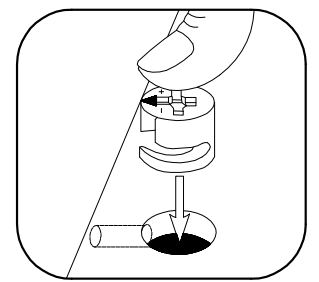
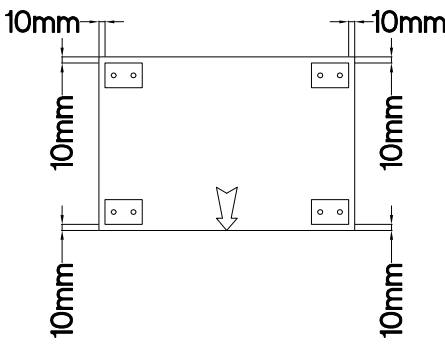
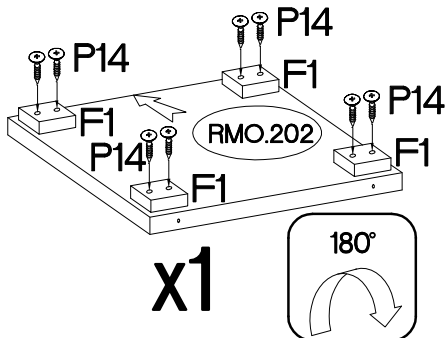
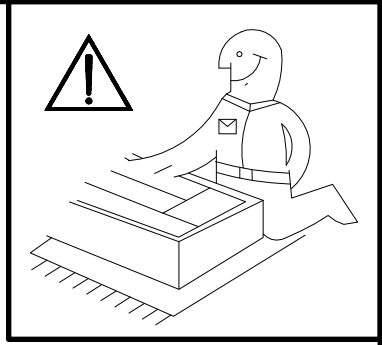

19

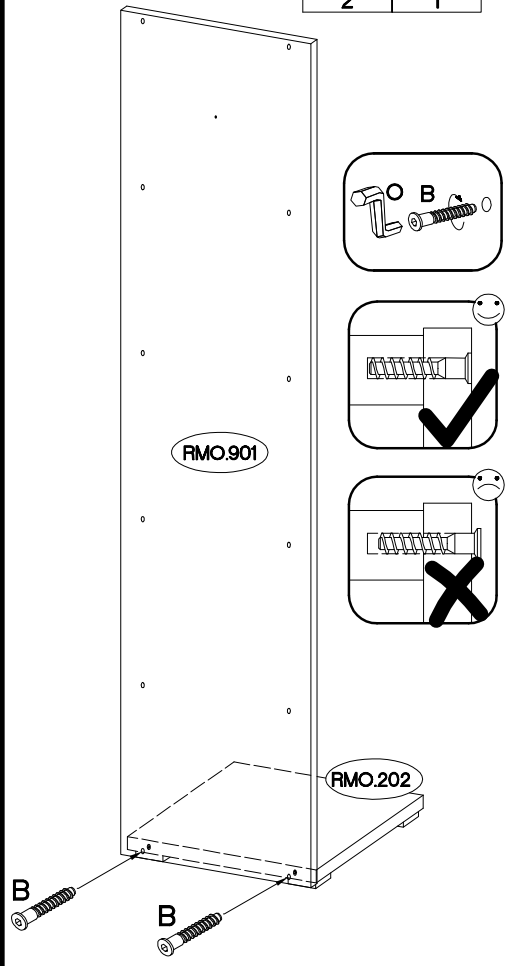
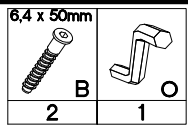

20

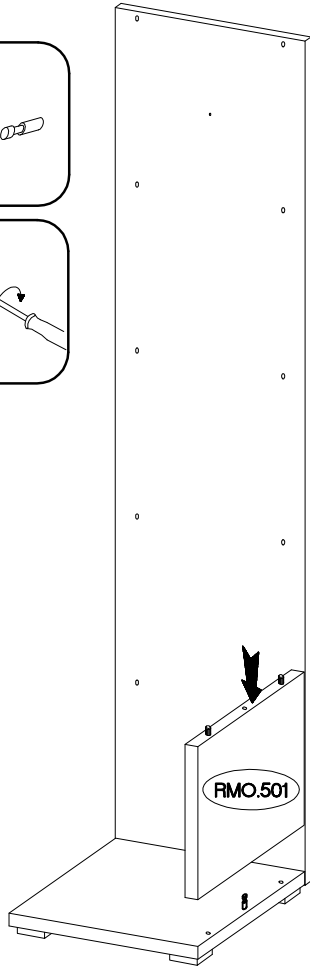
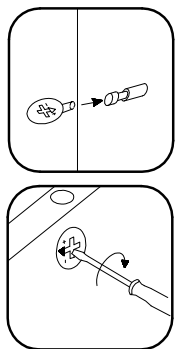

21

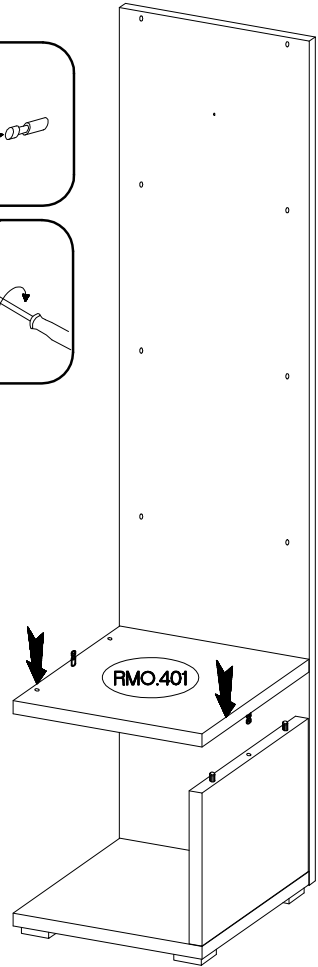
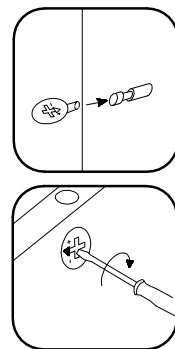

22

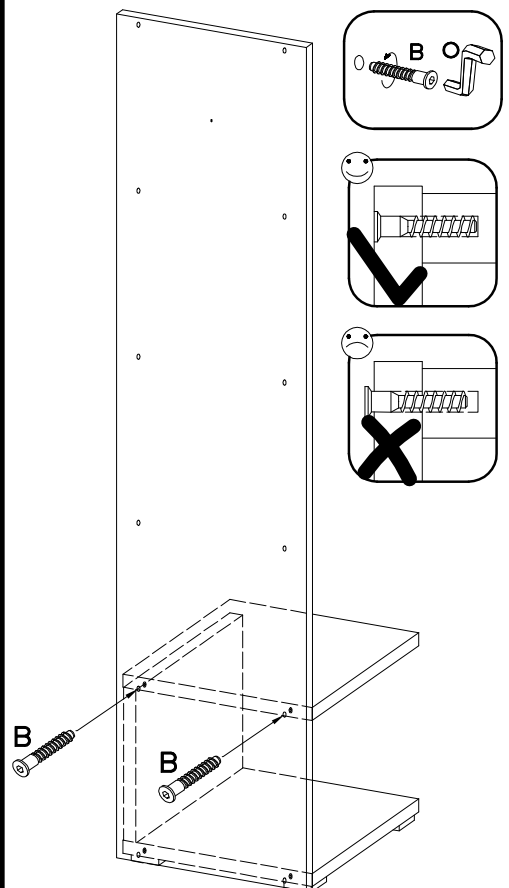
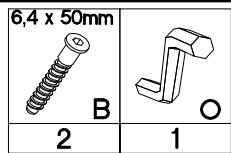

23

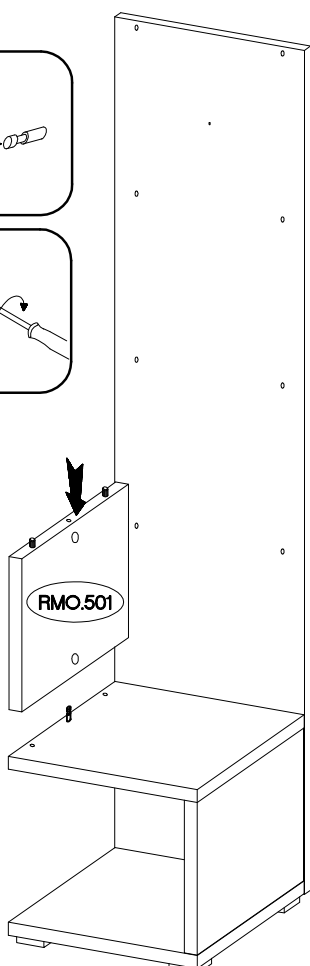
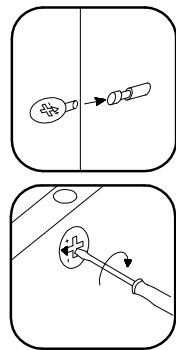

24

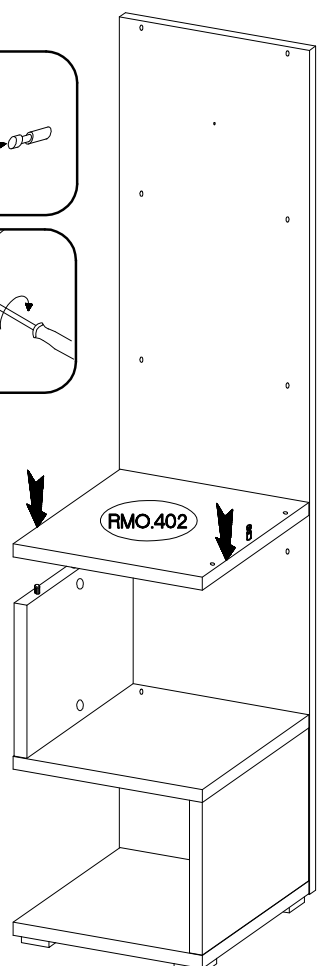
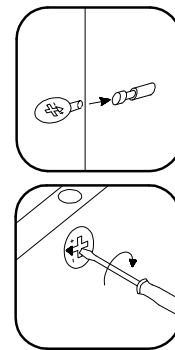

25

6,4 x 50mm



B

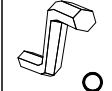

O

2

1

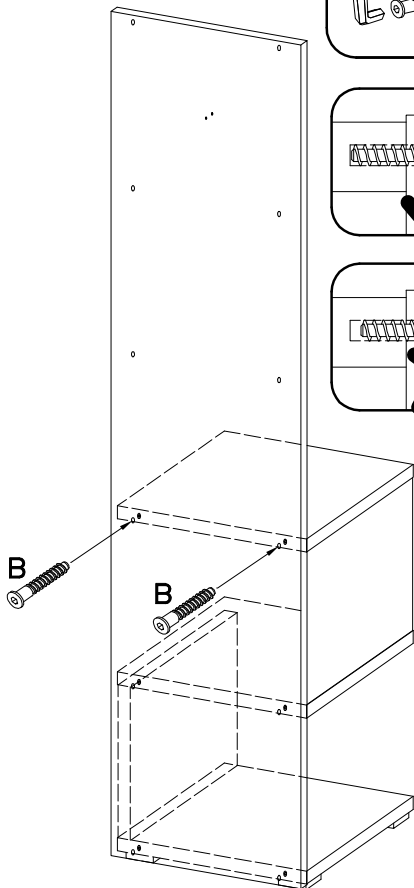
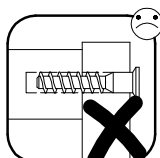
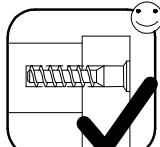
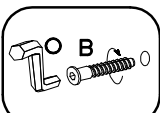

26

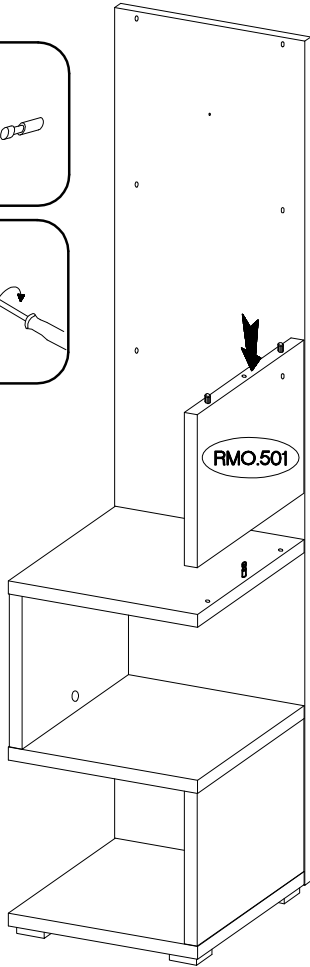
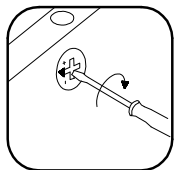
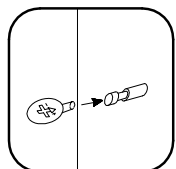

27

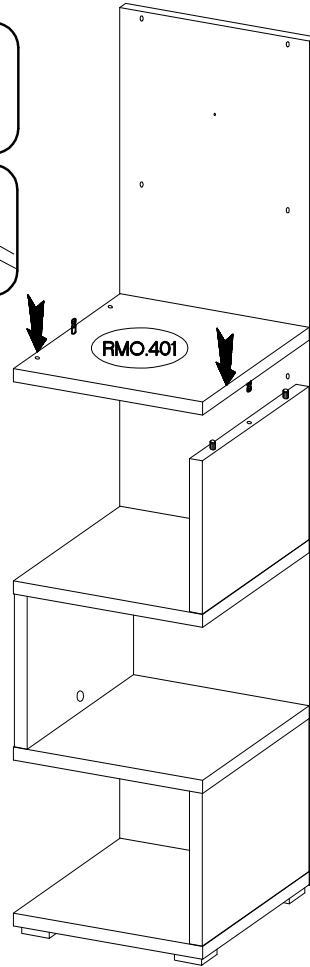
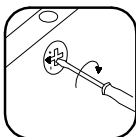
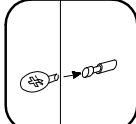

28

6,4 x 50mm



B

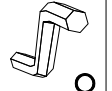

O

2

1

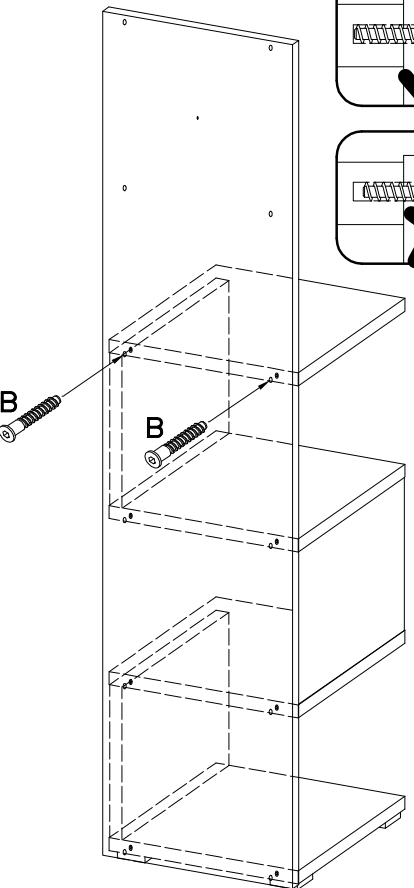
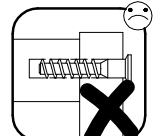
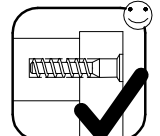
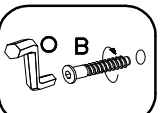

29

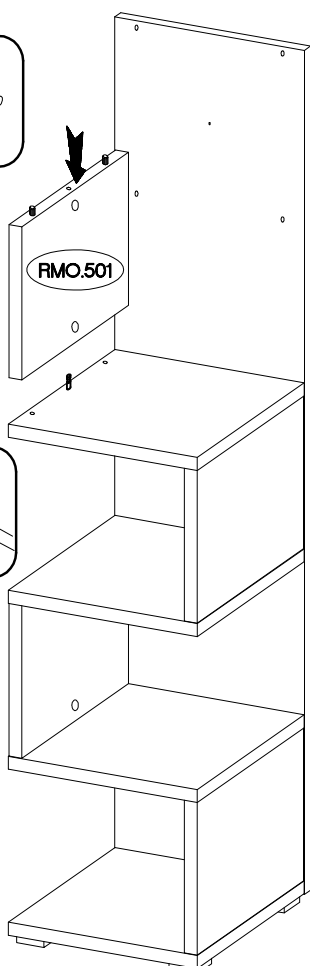
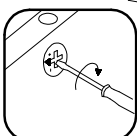
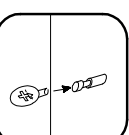

30

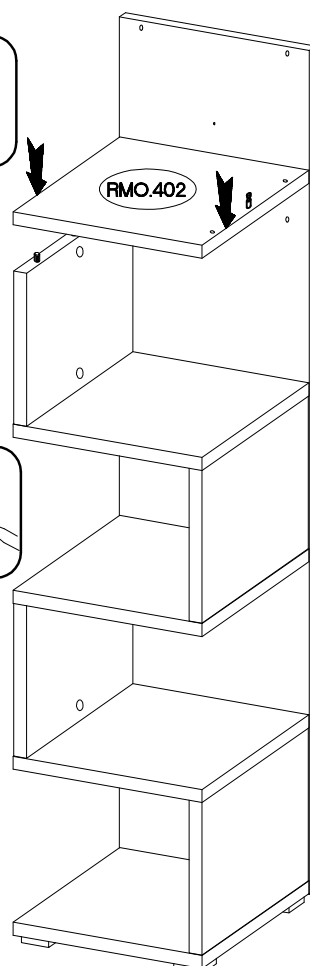
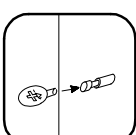

31

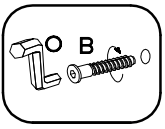

6,4 x 50mm



2

1

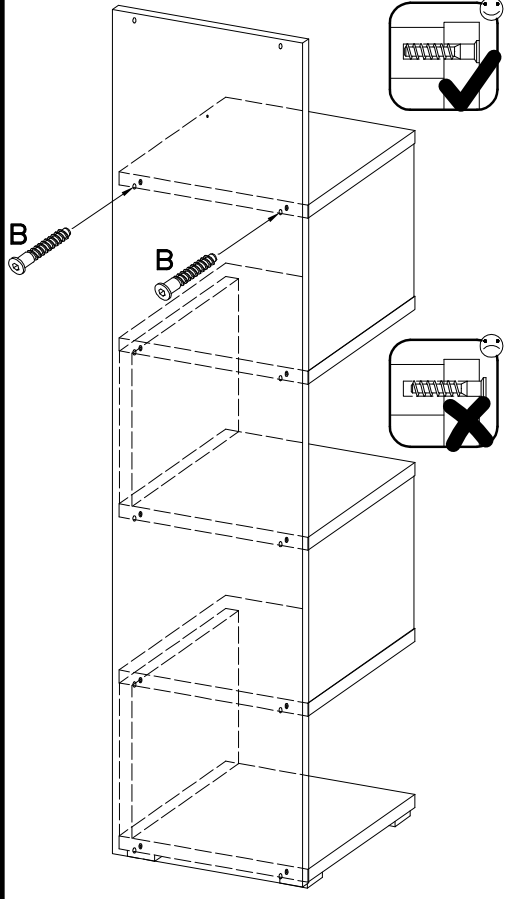

32

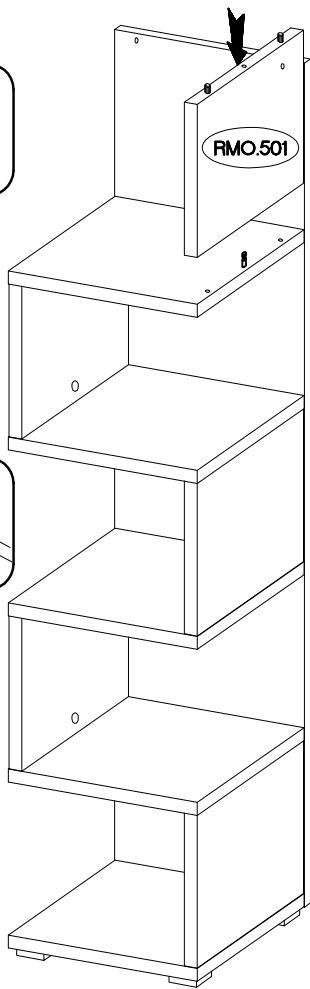
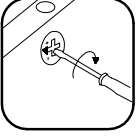
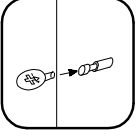

33

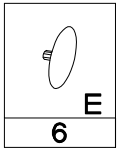
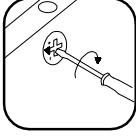
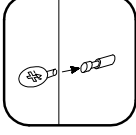

6

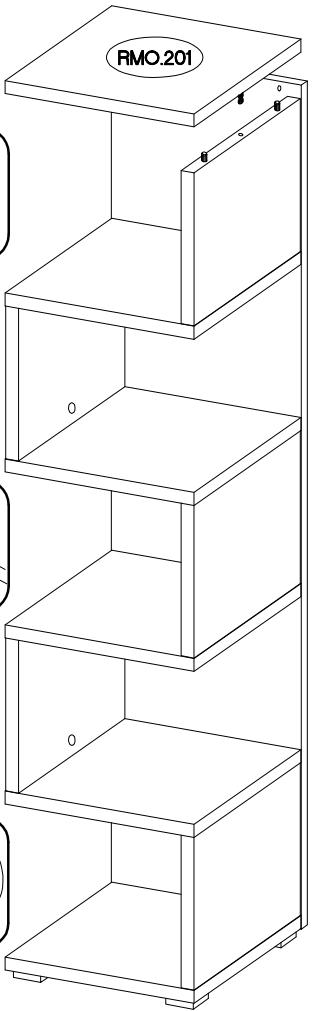
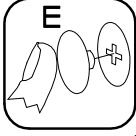

34



6,4 x 50mm

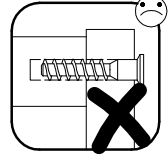
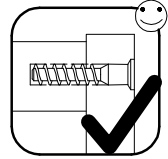
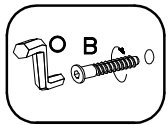
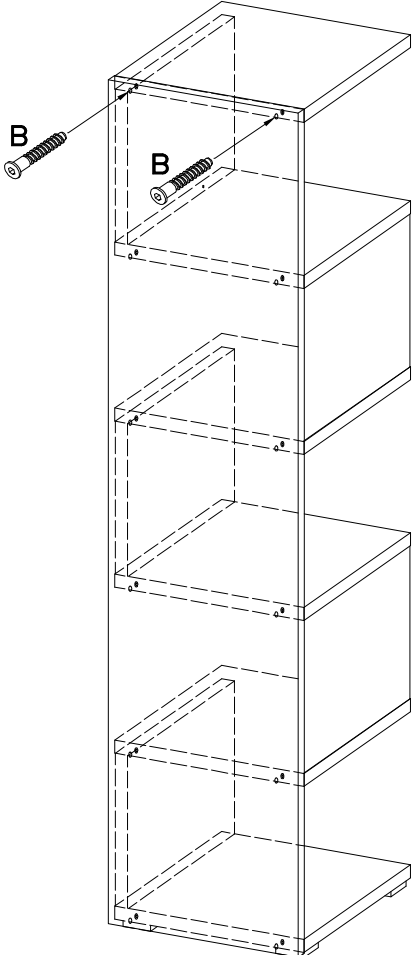

2

1



 #10x50mm O7 1	 #5.0x70mm P29 1	 #20 E11 1
--	--	--

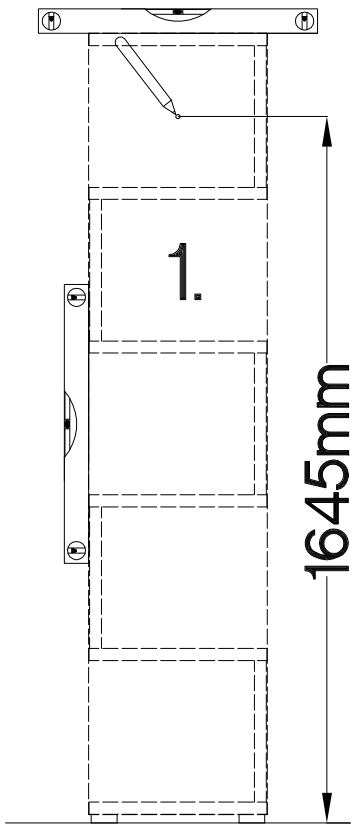
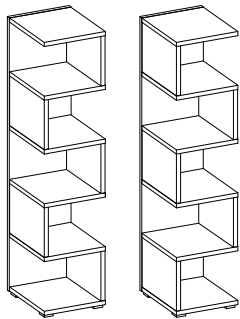

Ø10mm

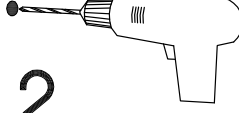

2.

O7

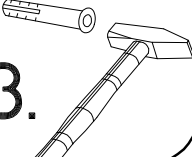

3.

