

MORRISON

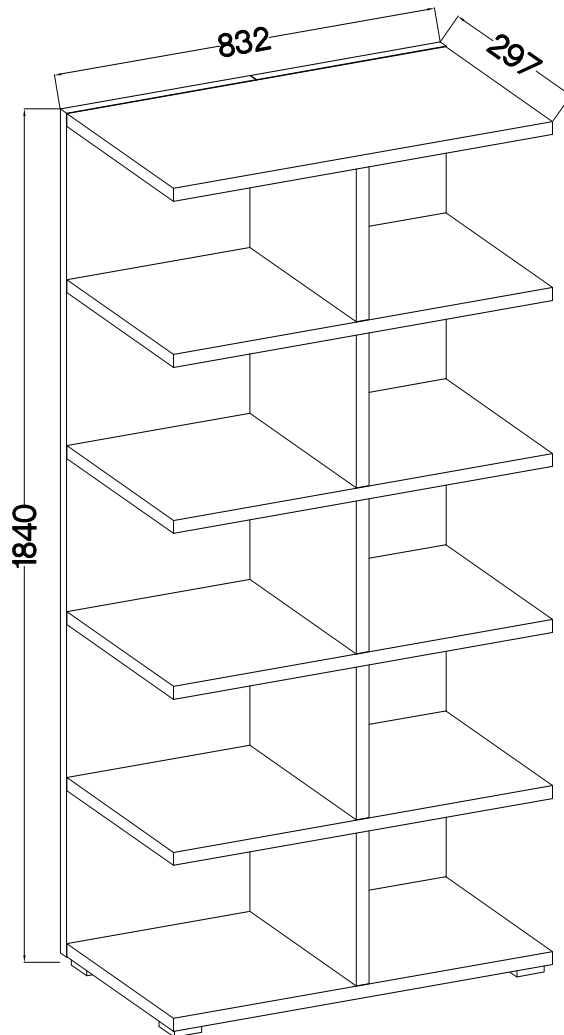

 <b>†10x50mm</b> <b>O7</b>	 <b>†5.0x70mm</b> <b>P29</b>	 <b>†20</b> <b>E11</b>
2	2	2

 <b>†8x30mm</b> <b>A</b>	 <b>6,4 x 50mm</b> <b>B</b>	 <b>†5/18mm</b> <b>C6</b>	 <b>L=20mm</b> <b>D2</b>	 <b>E</b>	 <b>60x40x20</b> <b>F1</b>	 <b>†4.0x25mm</b> <b>P14</b>	 <b>O</b>
20	24	10	10	10	4	8	1

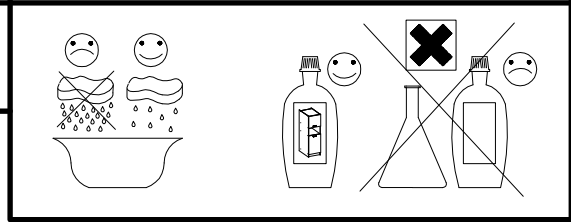
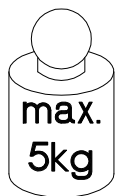
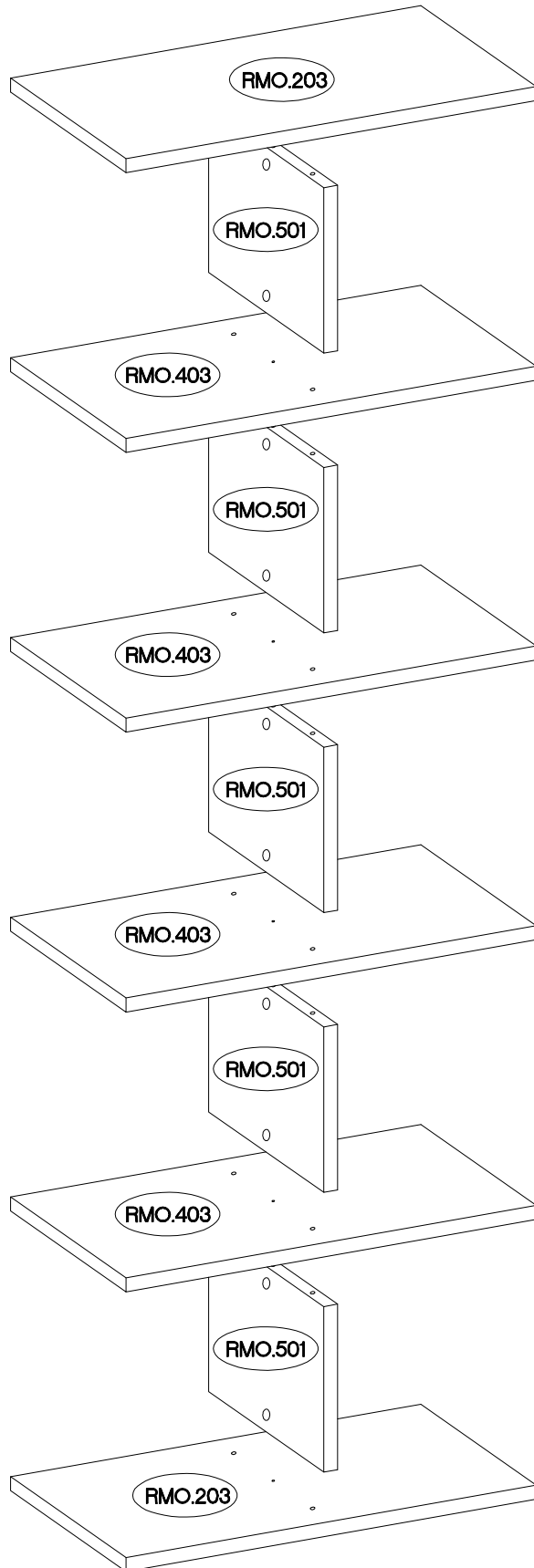
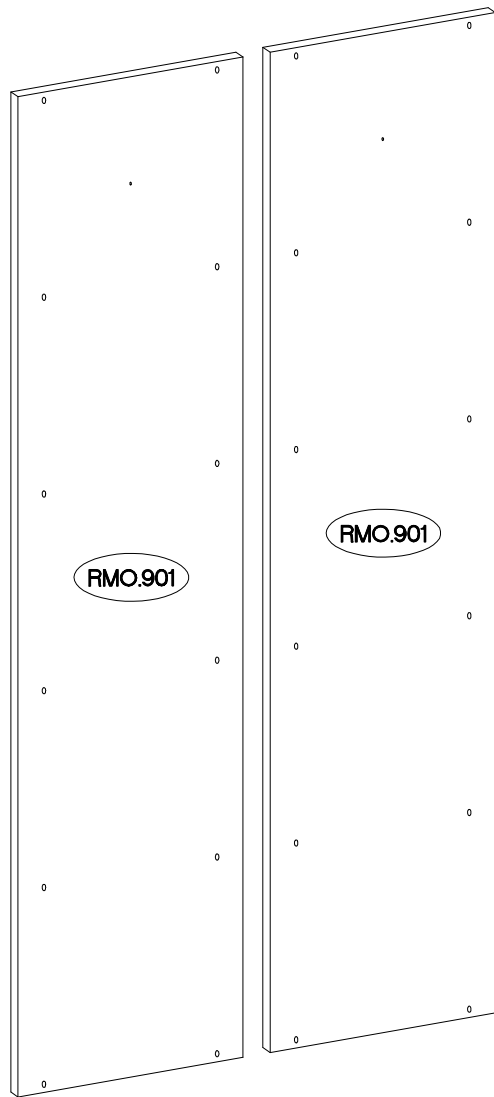





MSN.203

MSN.403

Colli	Ersatzteil Nummer	Dimension
Colli 1/2	RMO.203	830x281x28
	RMO.403 x 4	830x281x28
	RMO.501 x 2	330x280x28
Colli 2/2	RMO.203	830x281x28
	RMO.501 x 3	330x280x28
	RMO.901 x 2	1820x416x16

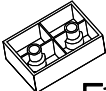
1

+8x30mm  A	+15/18mm  C6	L=20mm  D2	60x40x20  F1	+4.0x25mm  P14
20	10	10	4	8

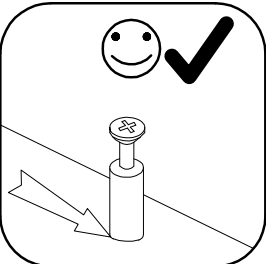
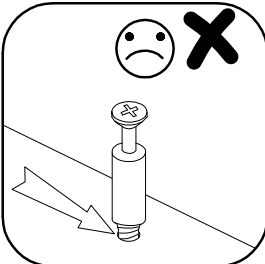
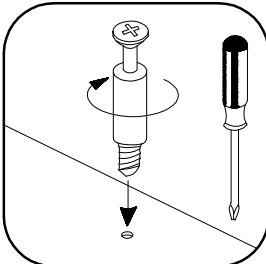
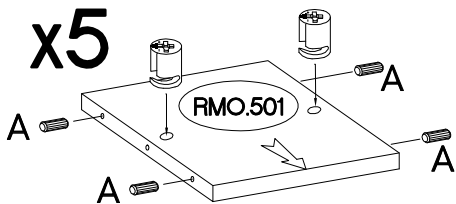
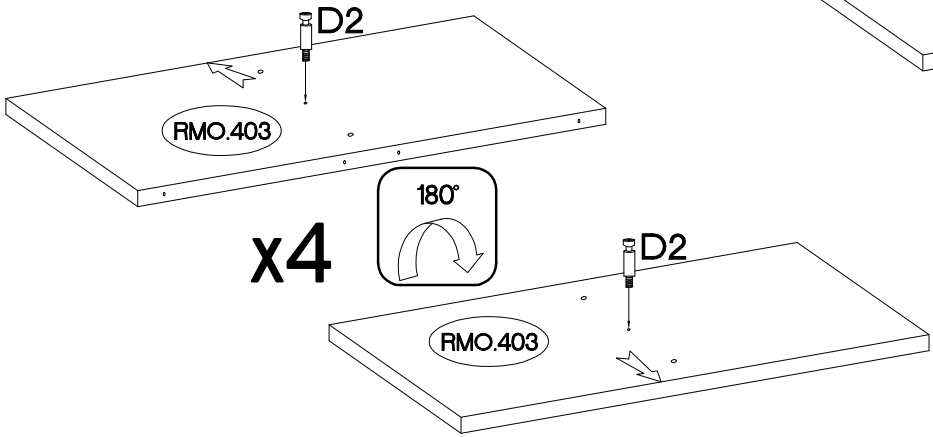
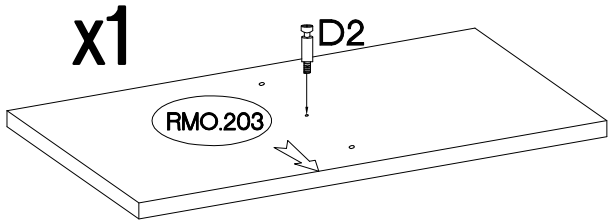
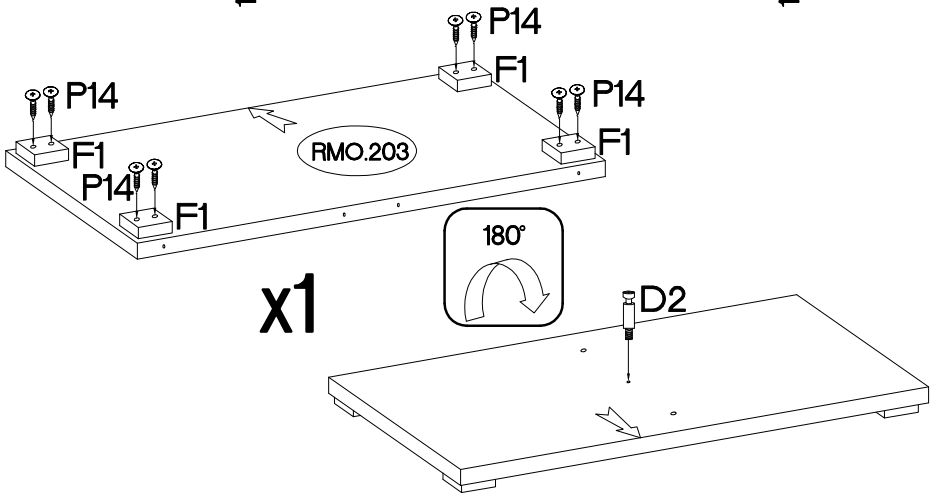
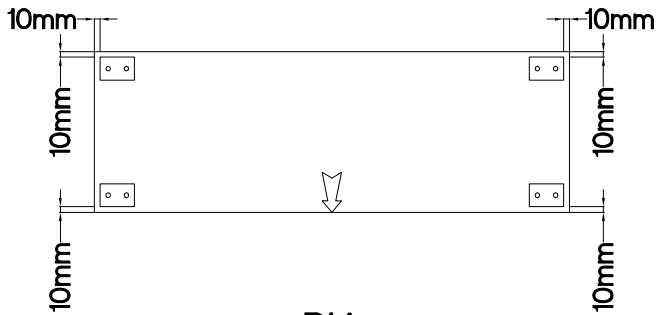
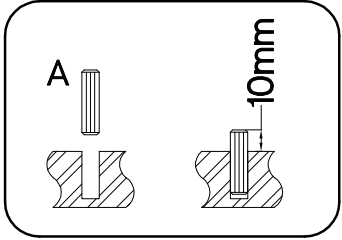
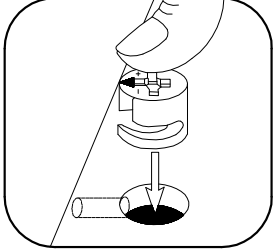
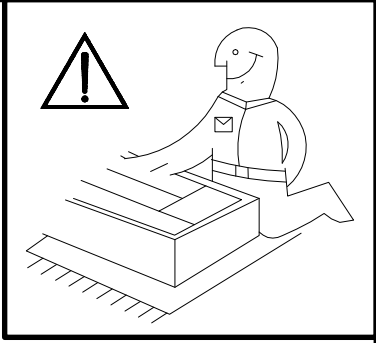

2

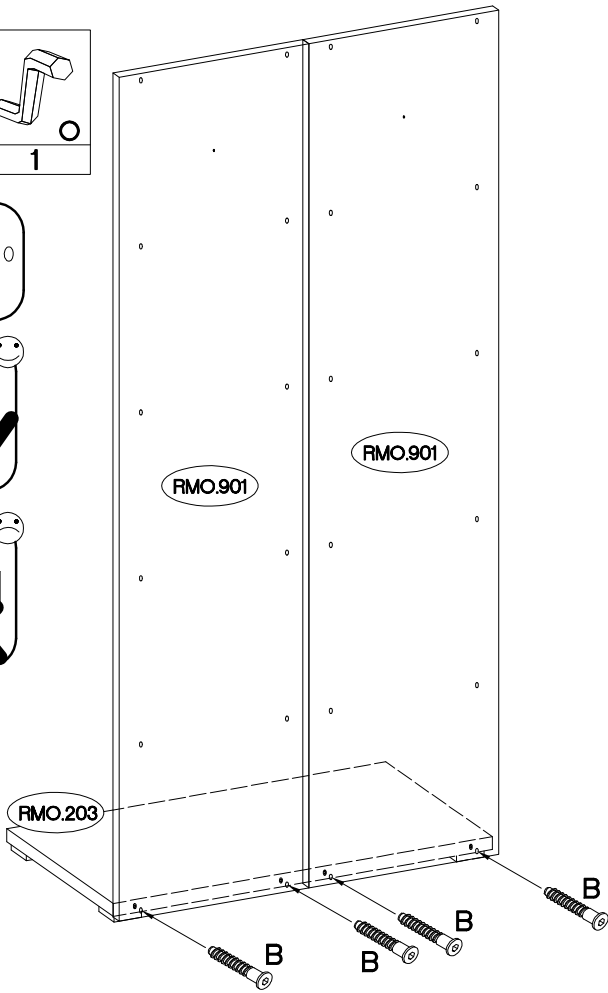
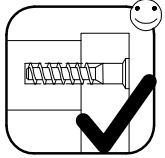
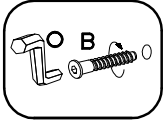
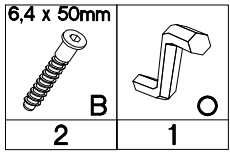

3

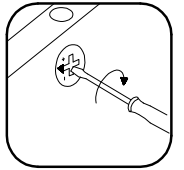
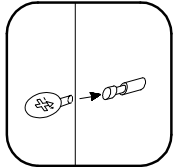
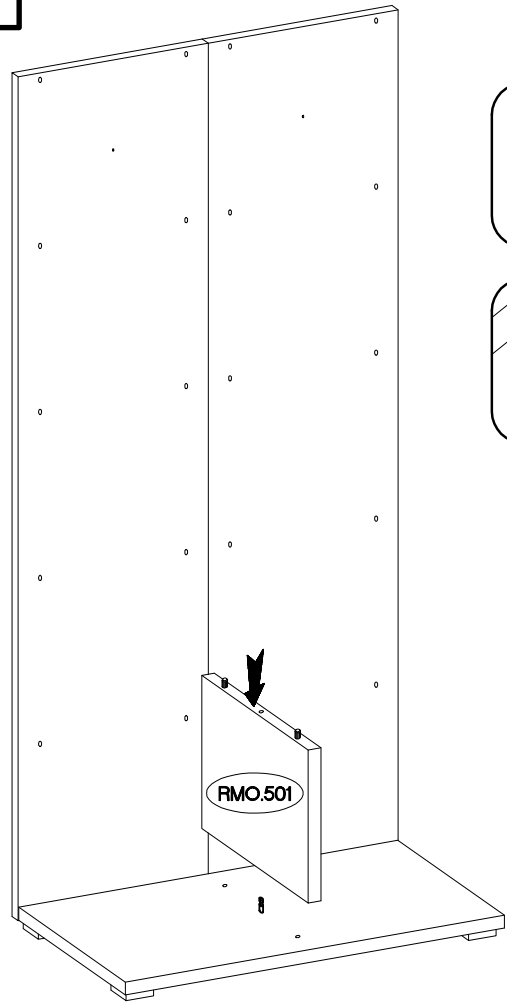

4

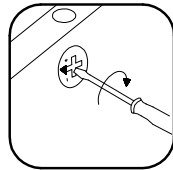
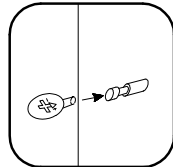
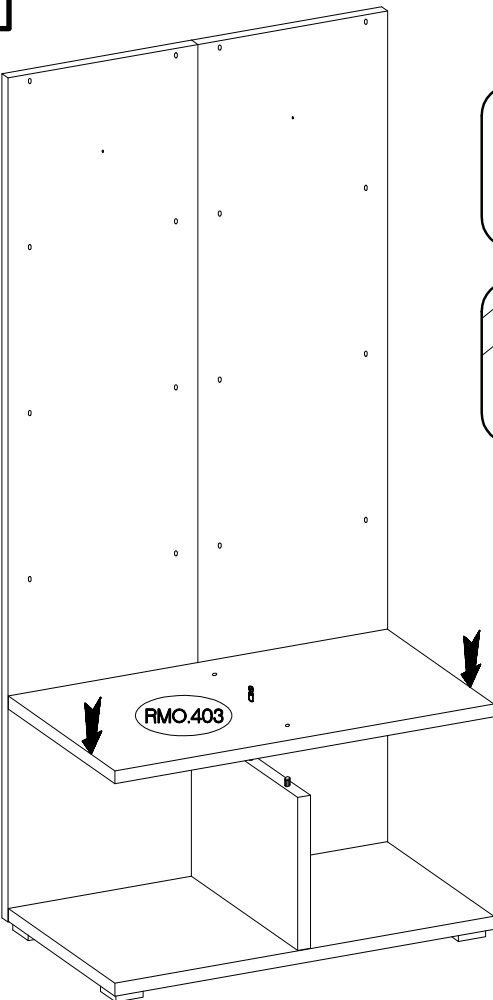

5

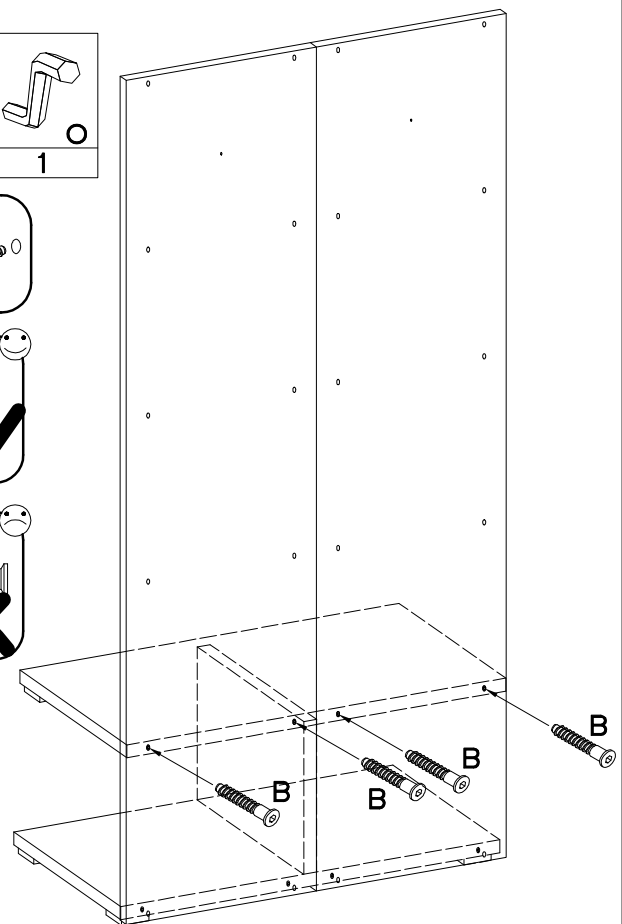
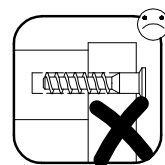
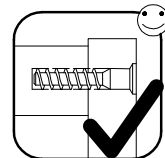
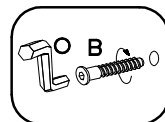
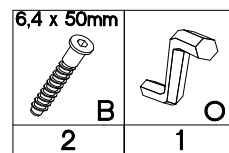

6

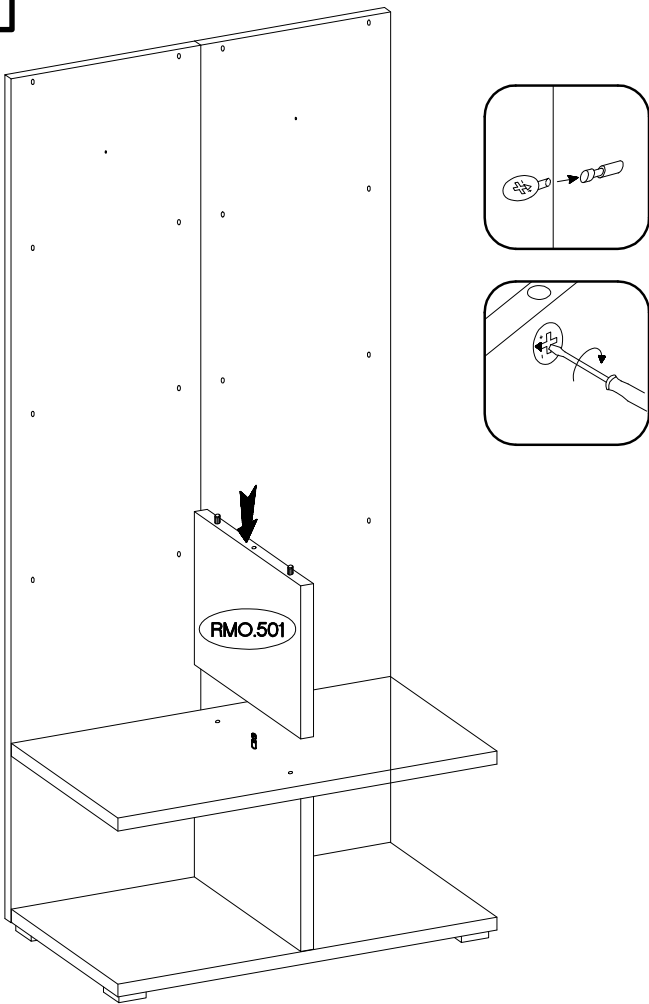

7

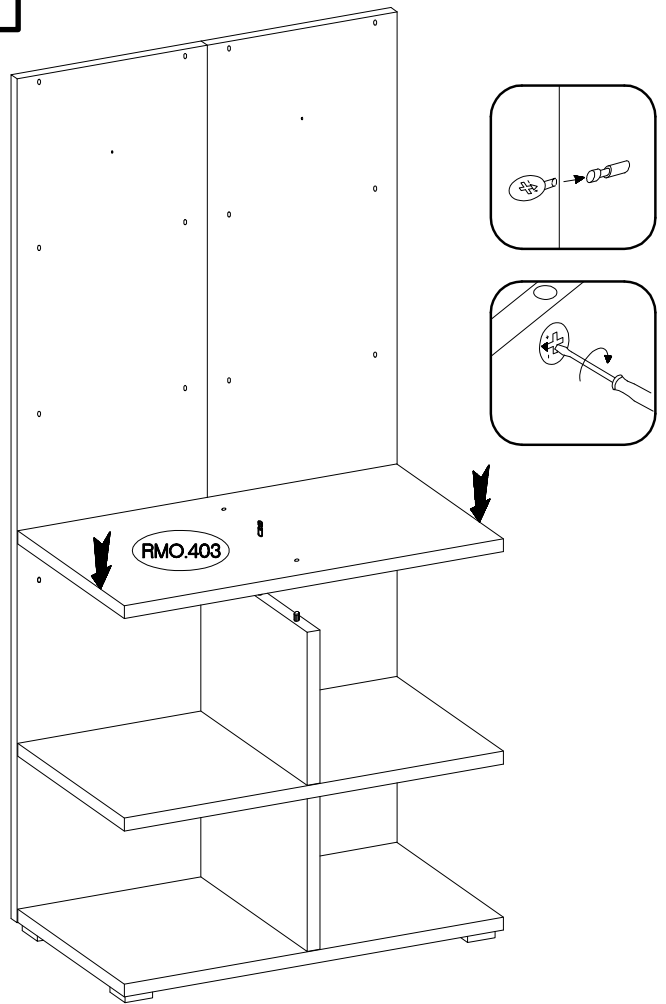

8

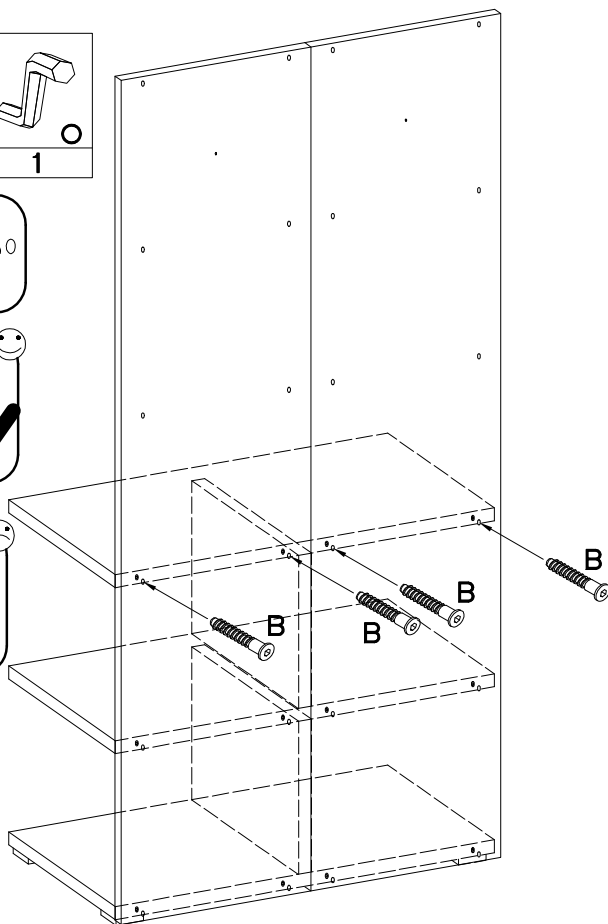
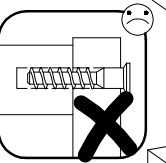
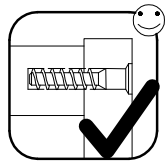
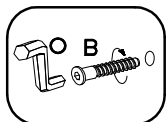
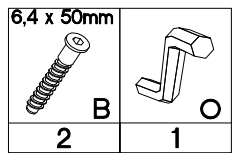

9

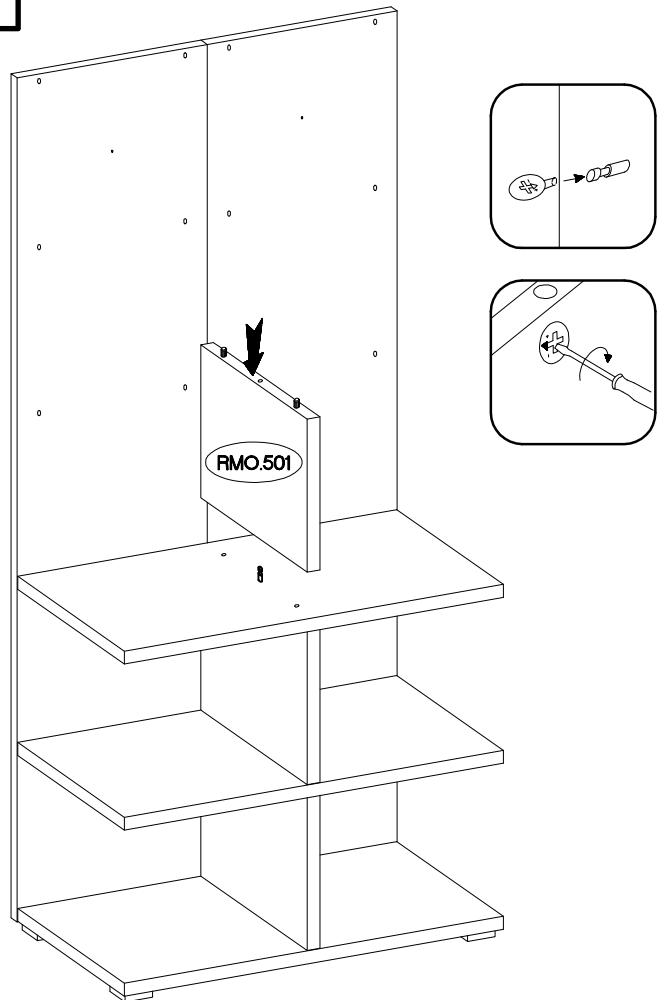

10

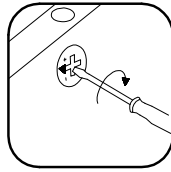
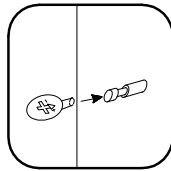
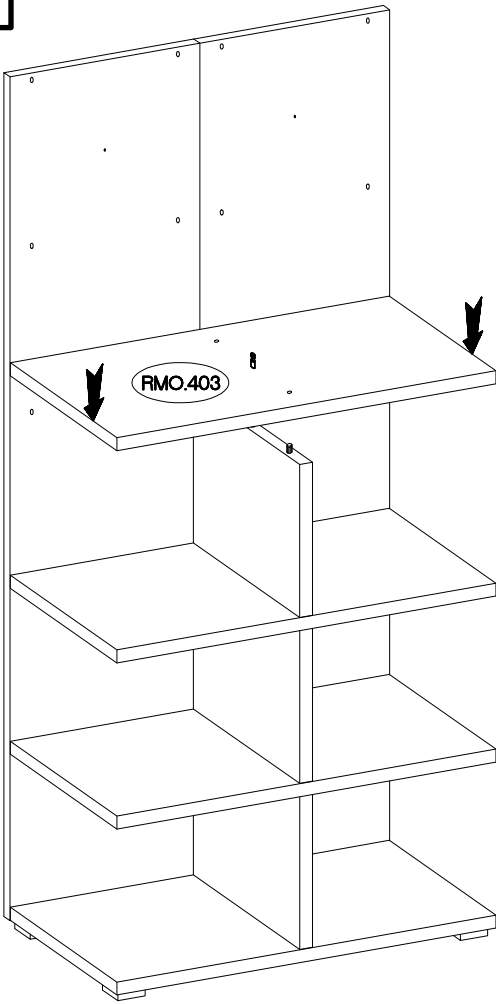

11

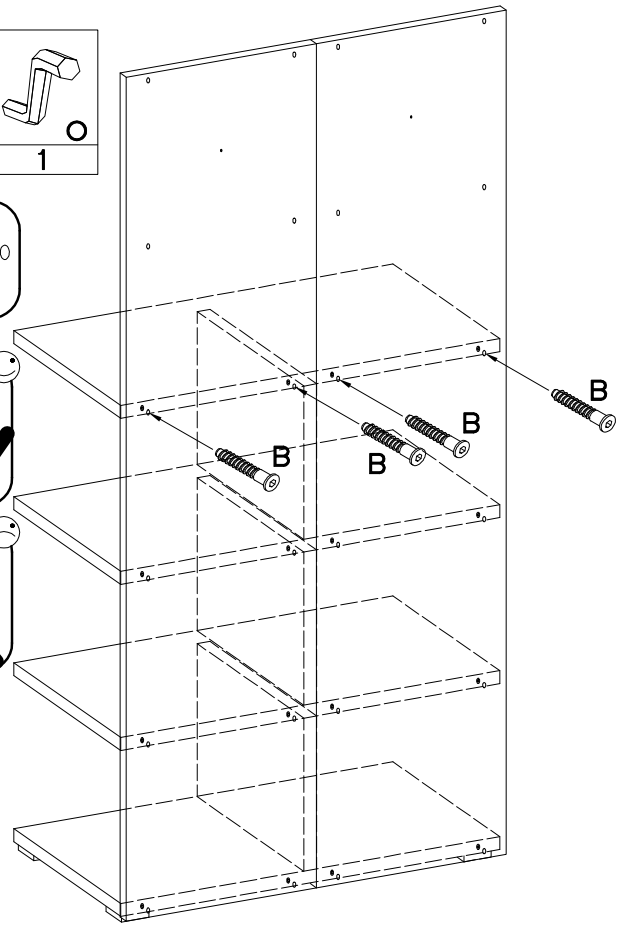
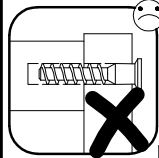
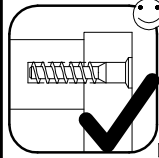
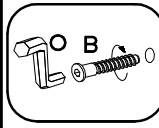
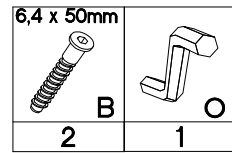

12

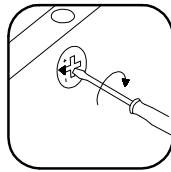
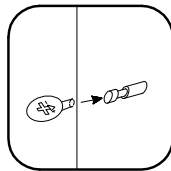
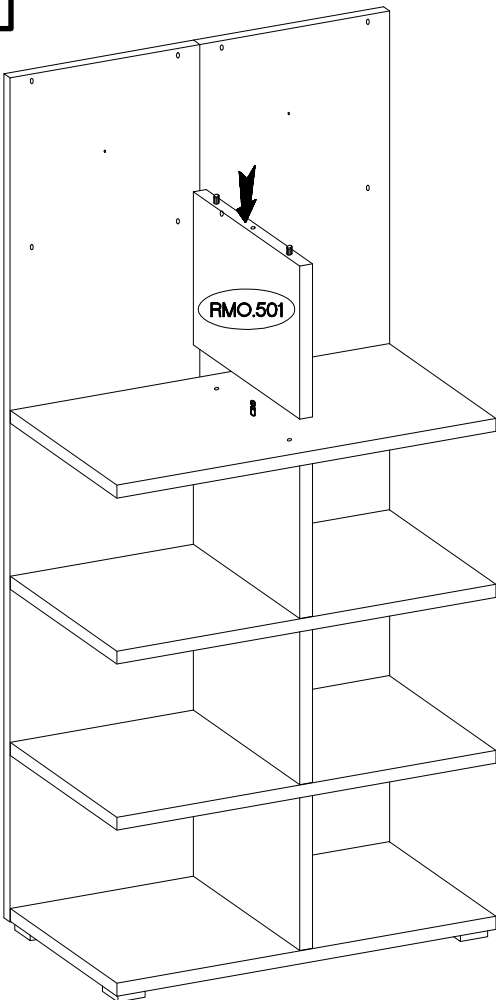

13

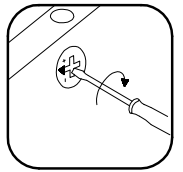
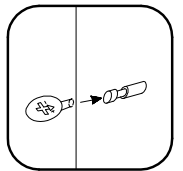
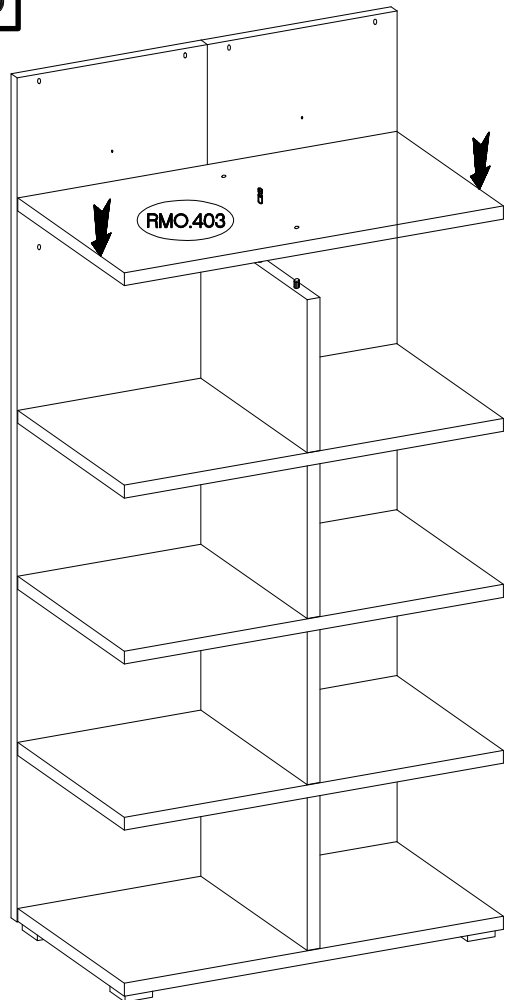

14

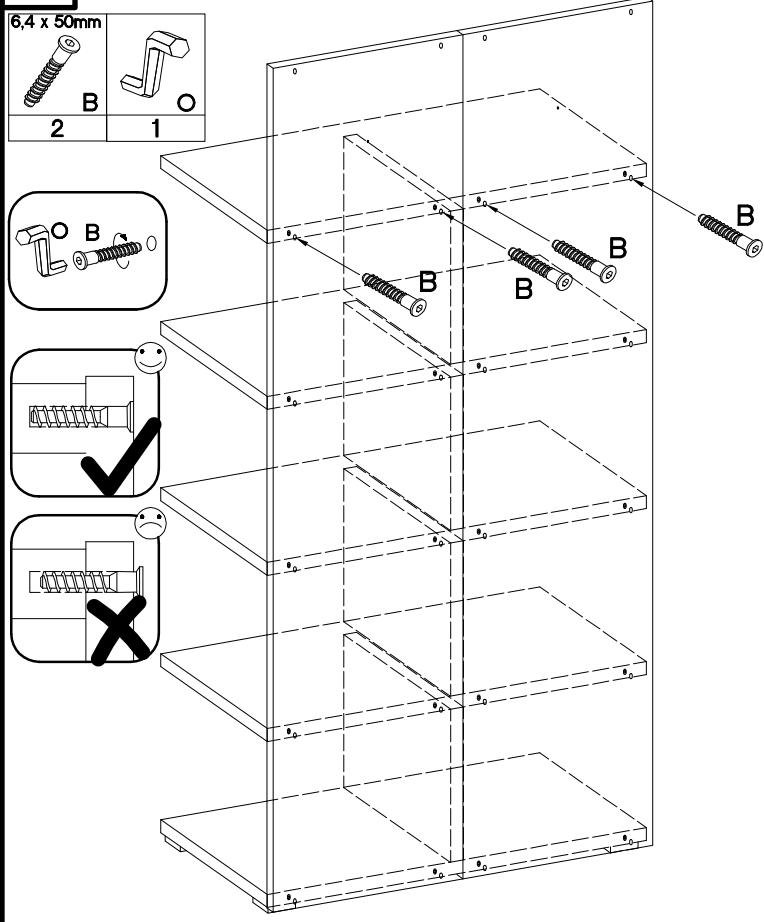

15

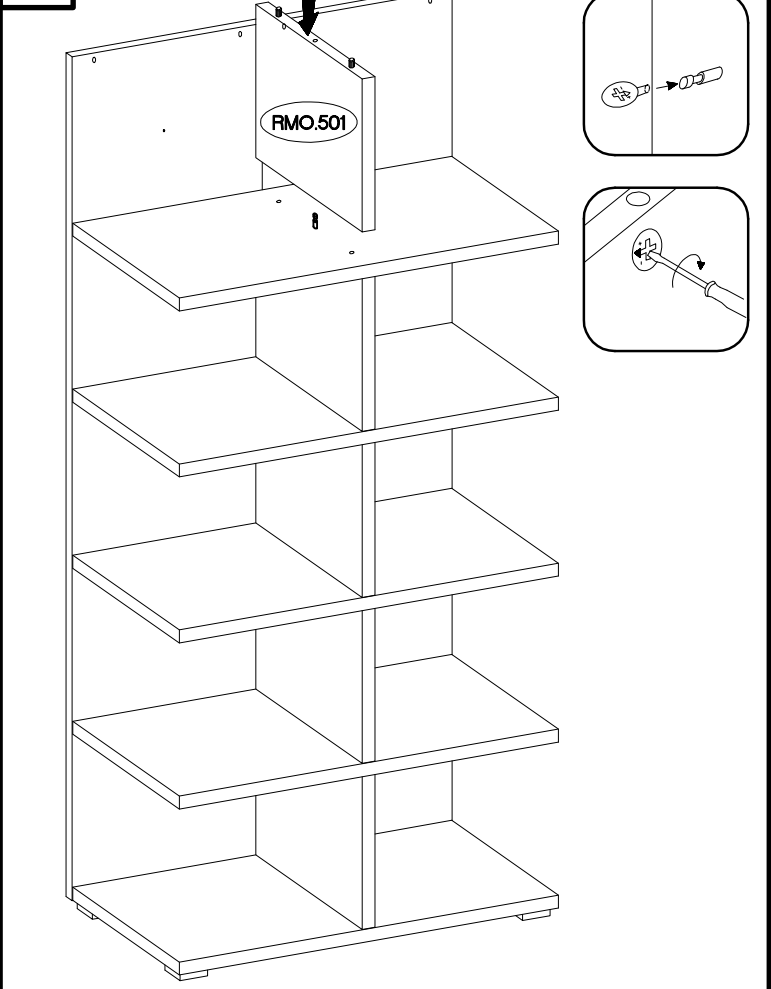

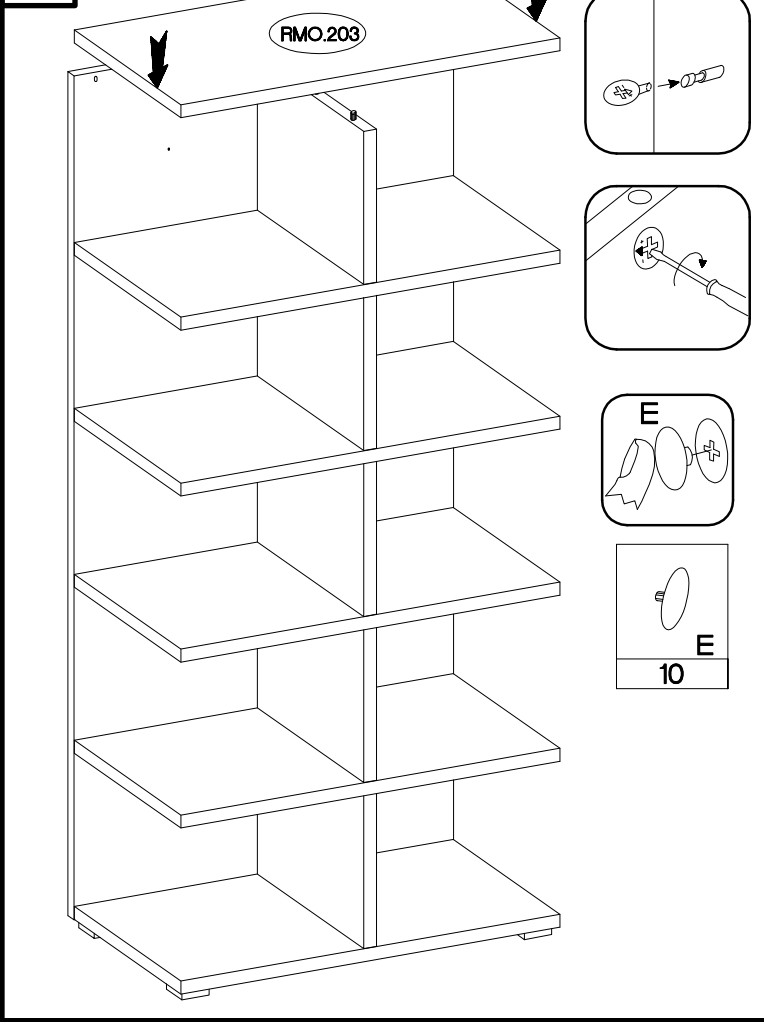

16

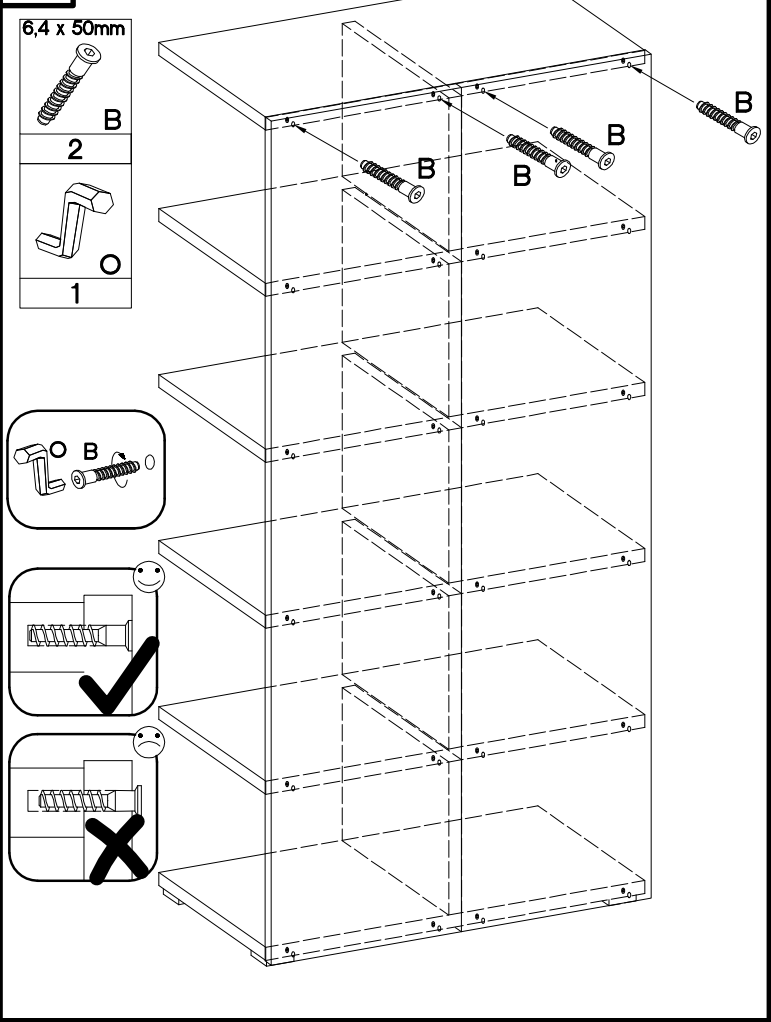

17



 $\varnothing 10 \times 50 \text{mm}$	 $\varnothing 5.0 \times 70 \text{mm}$	 $\varnothing 20$
O7 2	P29 2	E11 2

$\varnothing 10 \text{mm}$

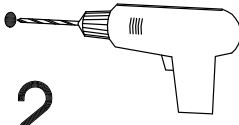

**2.**

O7

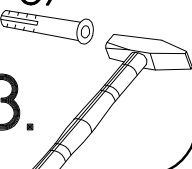

**3.**

