

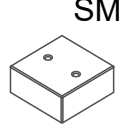





<p>8x30</p> <p>D</p> <p>20</p>	<p>A</p> <p>20</p>	<p>B</p> <p>28</p>	<p>S</p> <p>12</p>	<p>8x45</p> <p>D1</p> <p>2</p>	<p>H</p> <p>32</p>	<p>4x30 H3</p> <p>12</p>	<p>SM</p> <p>6</p>
<p>X</p> <p>28</p>	<p>L</p> <p>16</p>	<p>Z</p> <p>8</p>	<p>Z1</p> <p>8</p>	<p>A1</p> <p>4</p>	<p>UD</p> <p>2</p>	<p>4x16 H1</p> <p>40</p>	<p>UM</p> <p>2</p>

H3	SM	A
		
12	6	12

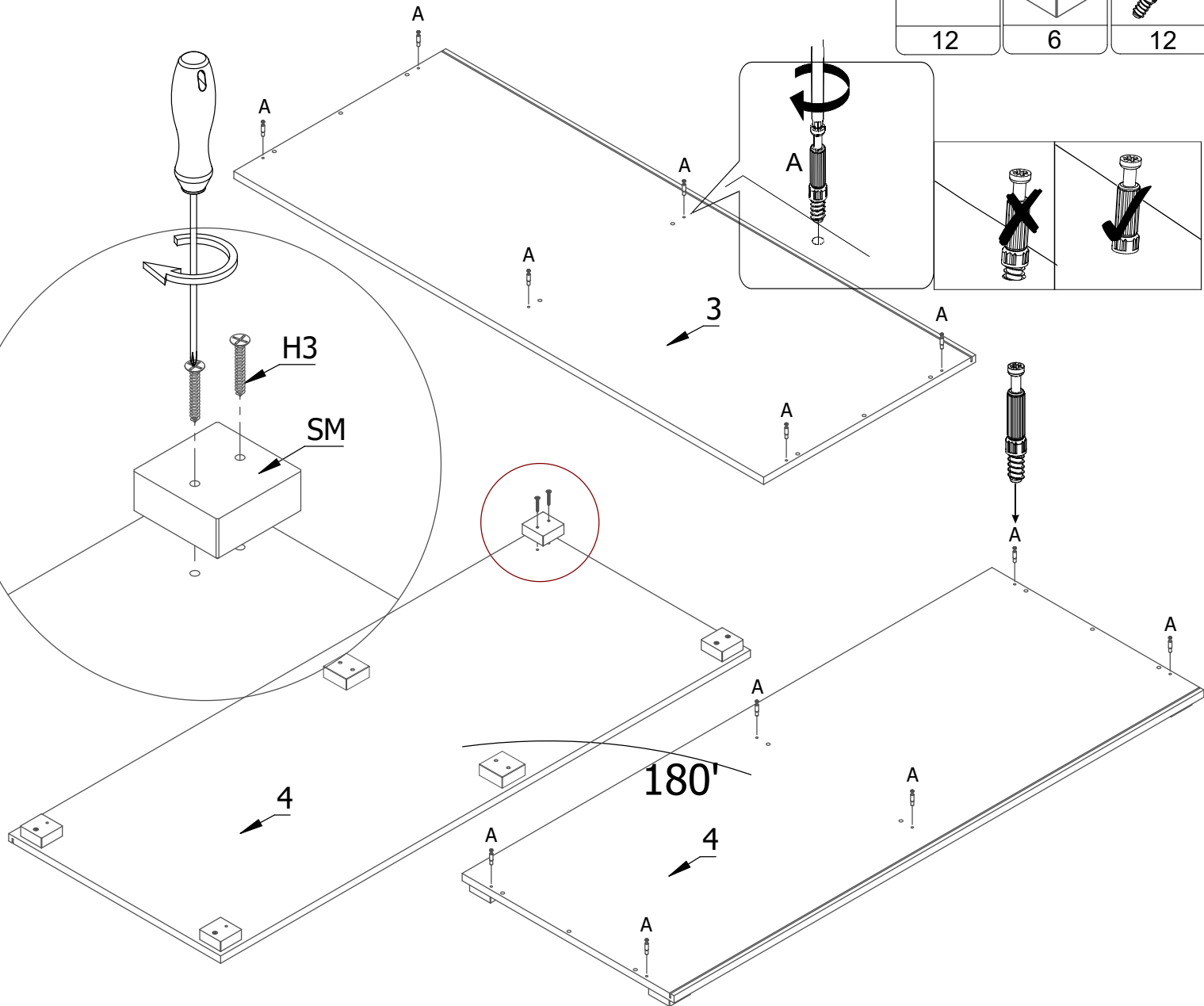

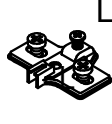
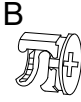
S	L	B	D	A
				
6	4	4	6	4

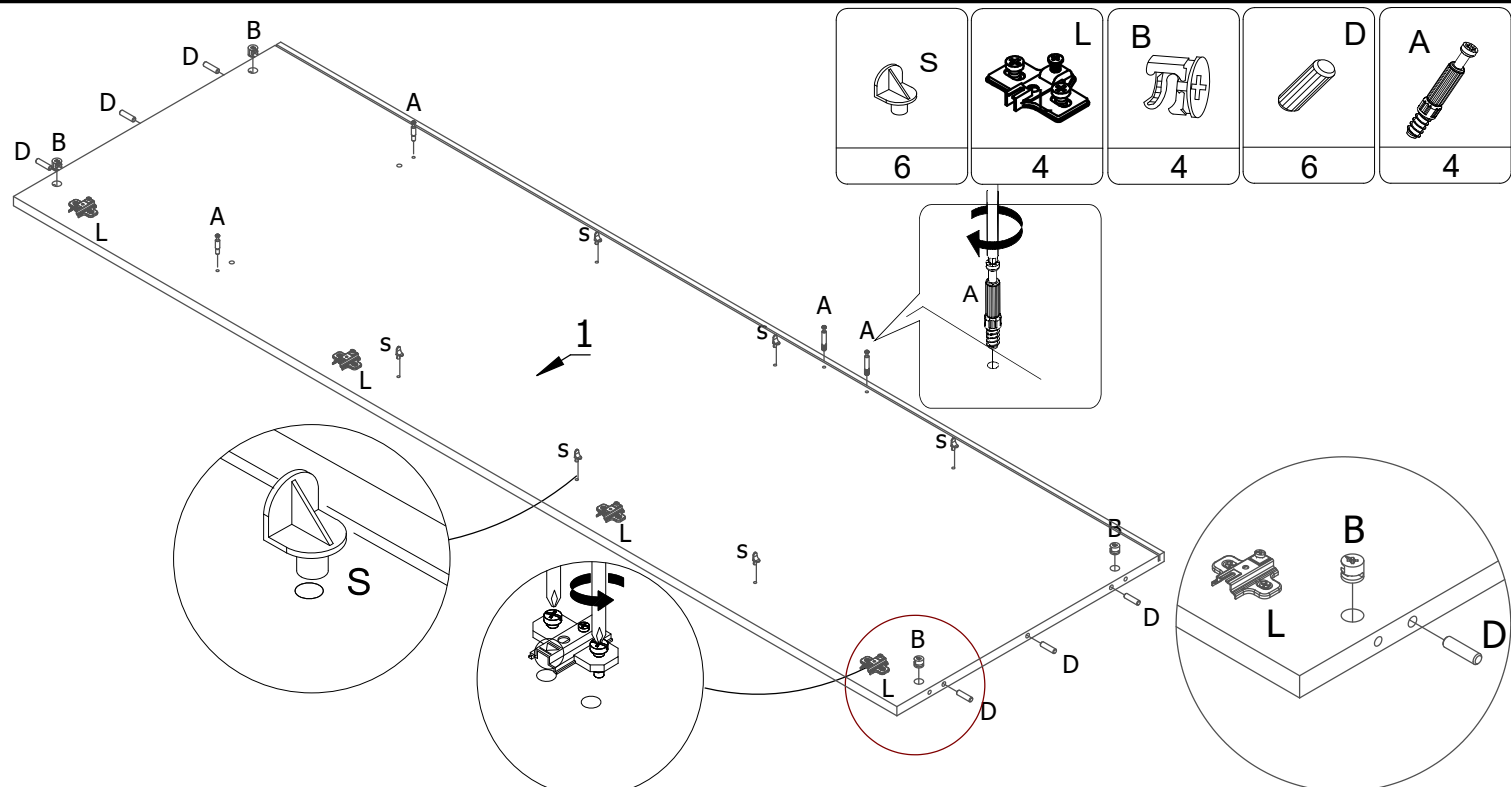

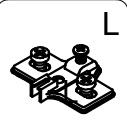
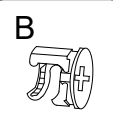
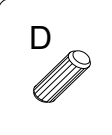
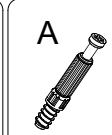
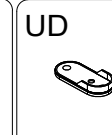
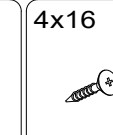
					
4	4	6	4	1	2

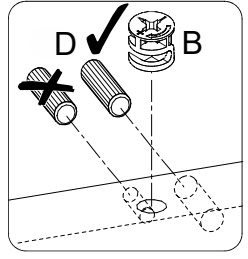
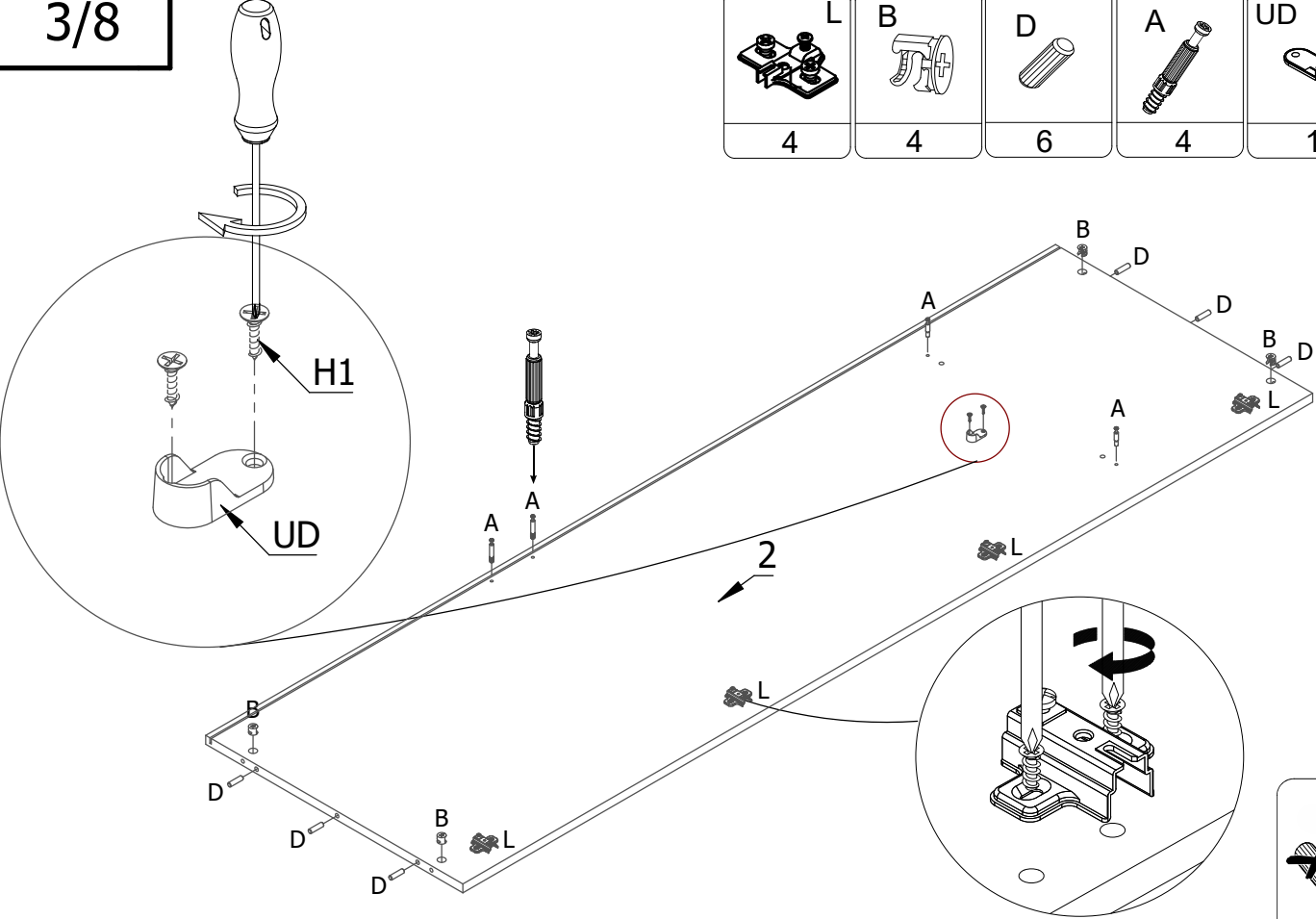

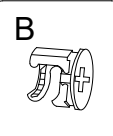
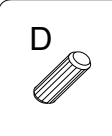
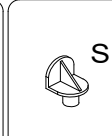
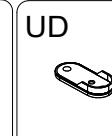
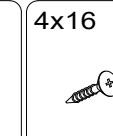
					
8	4	4	6	1	2

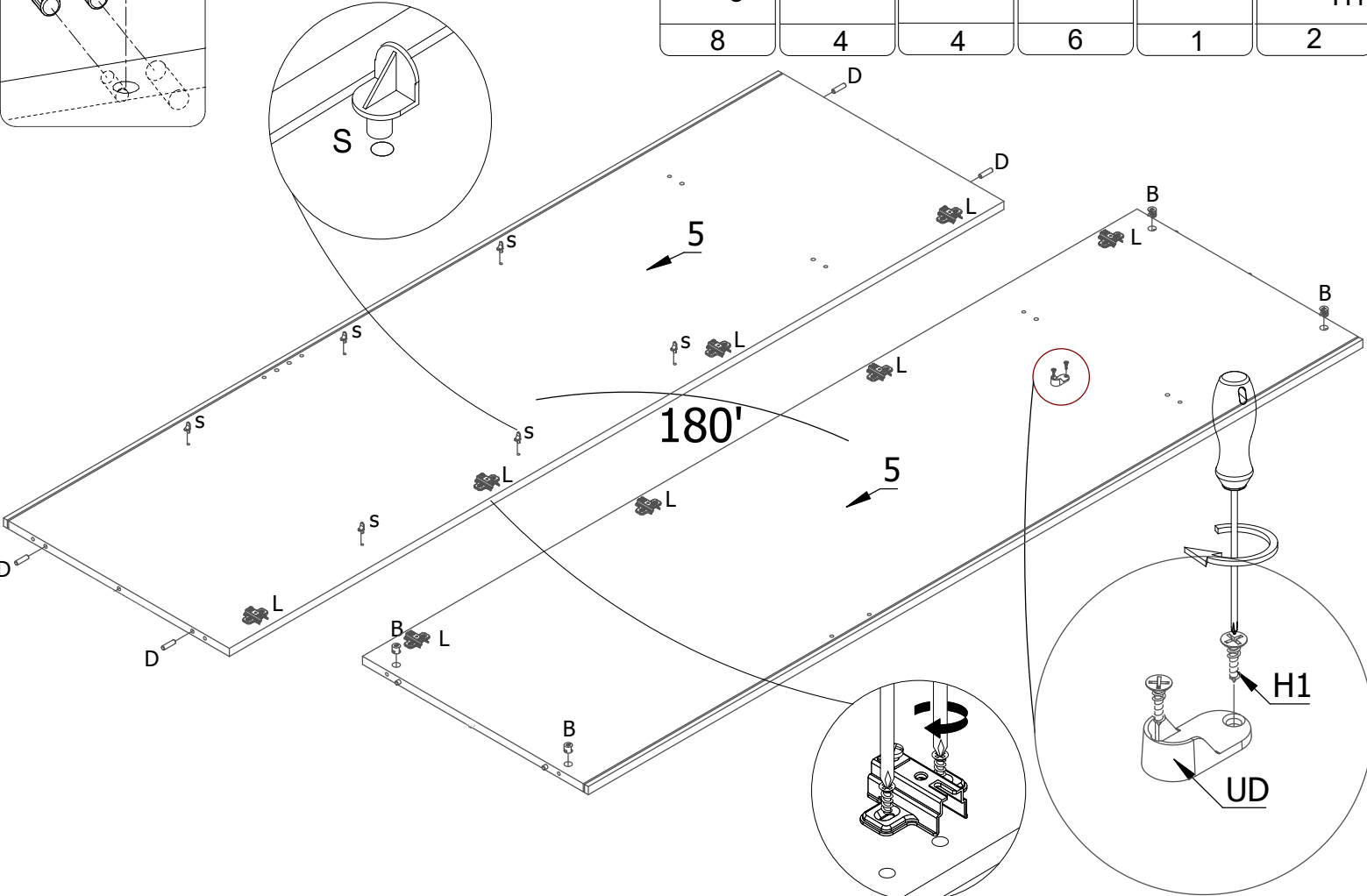
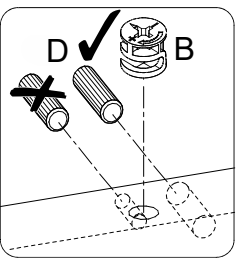

Z	Z1	4x16
8	8	32
		H1

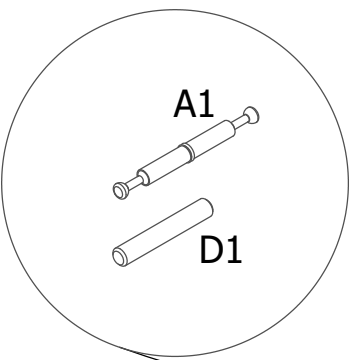
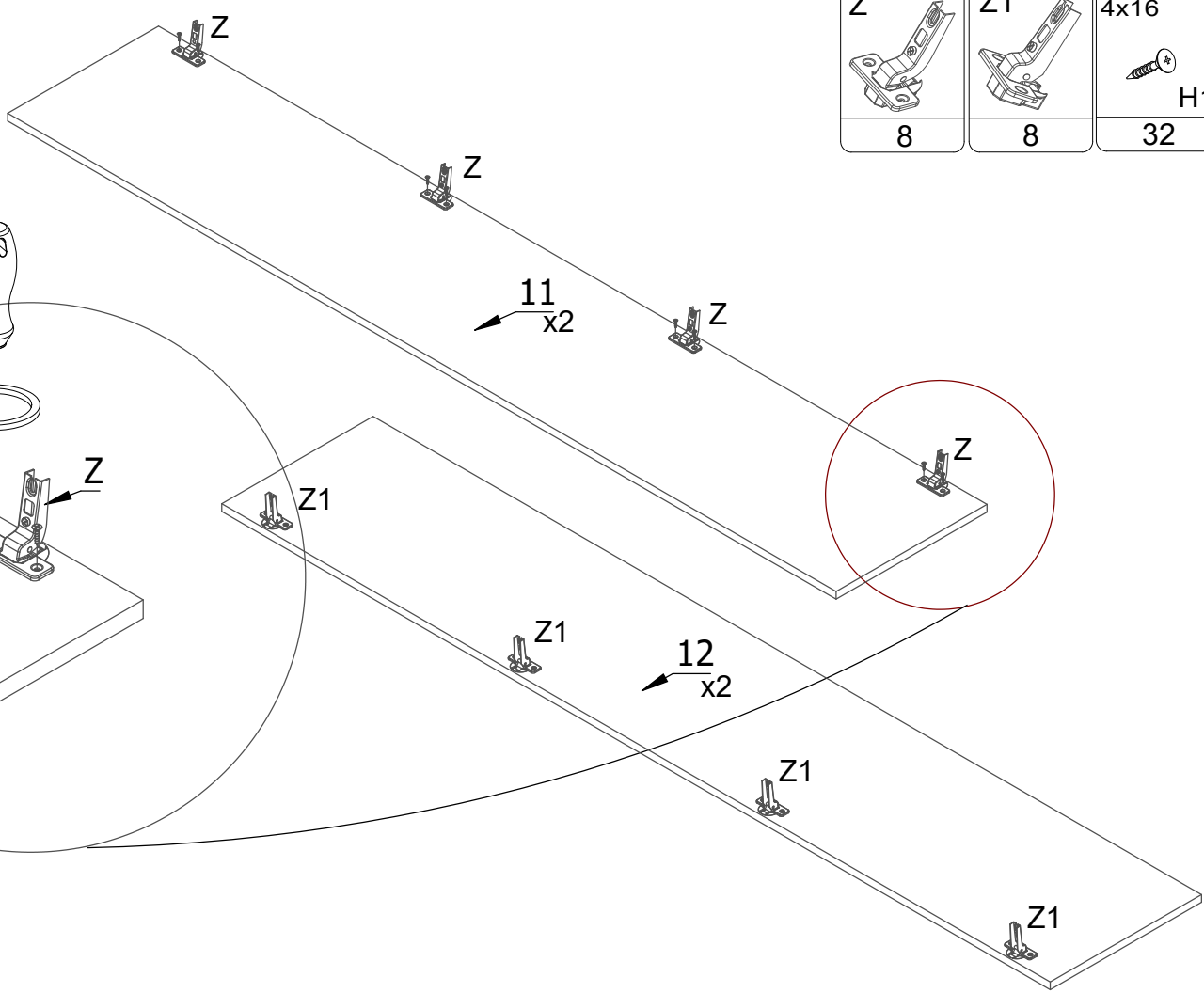
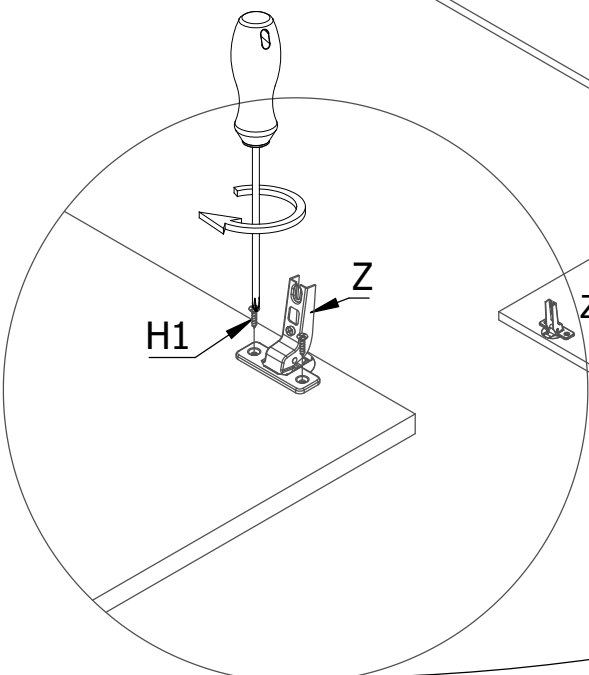

D	8.0x45
4	2
A1	B
2	8

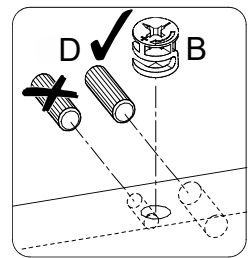
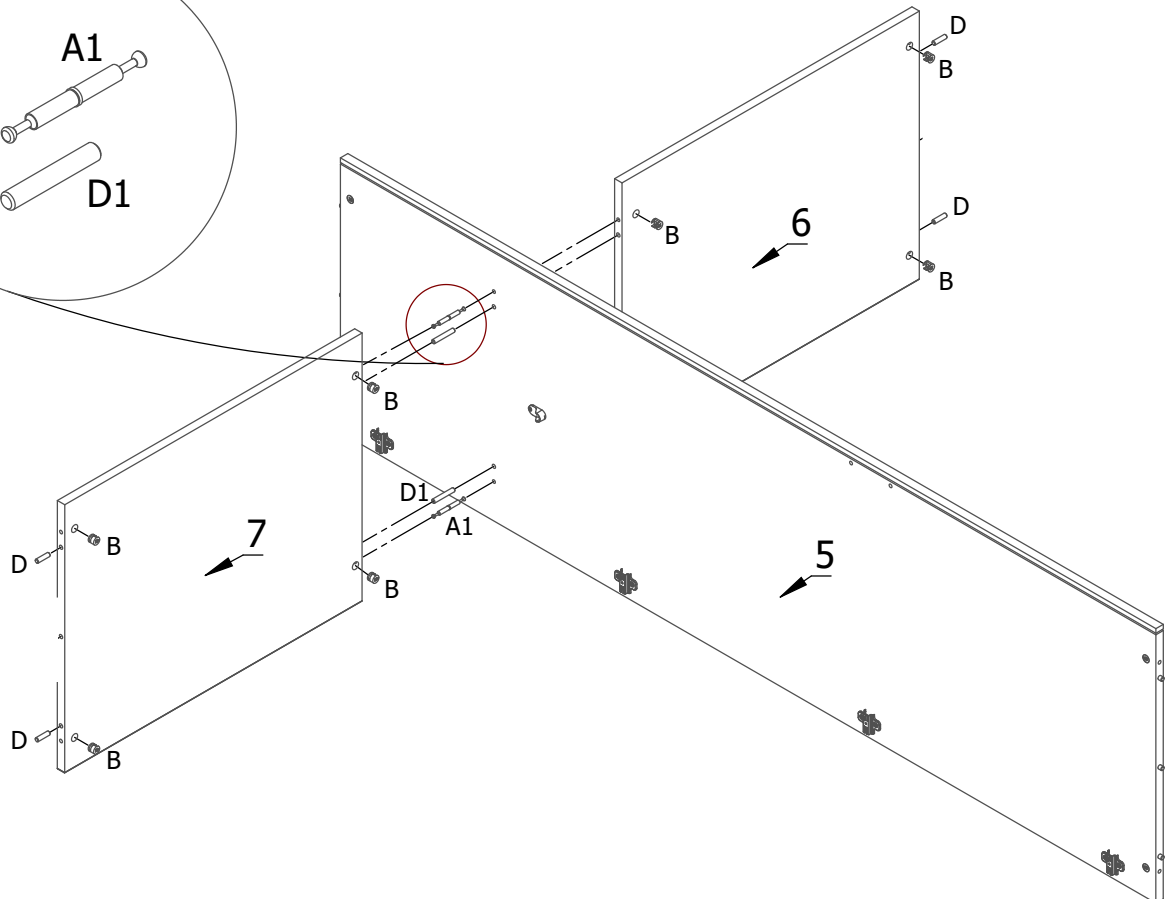

A1

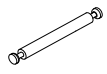

2

B



8

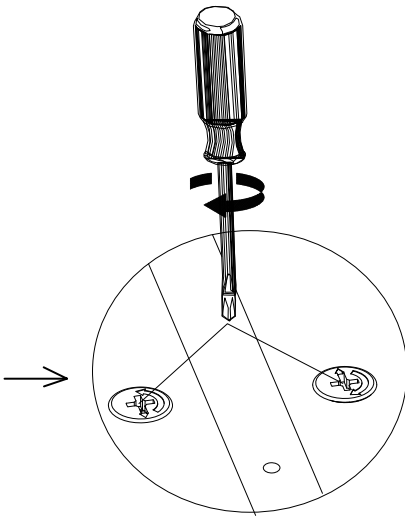
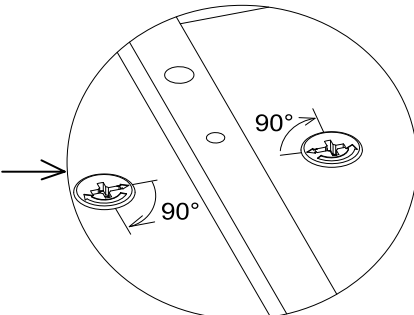
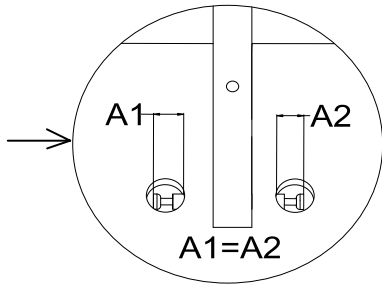
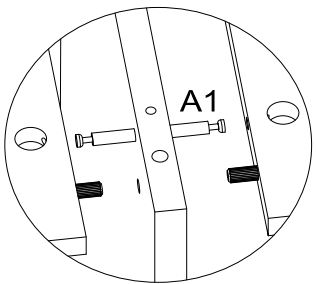
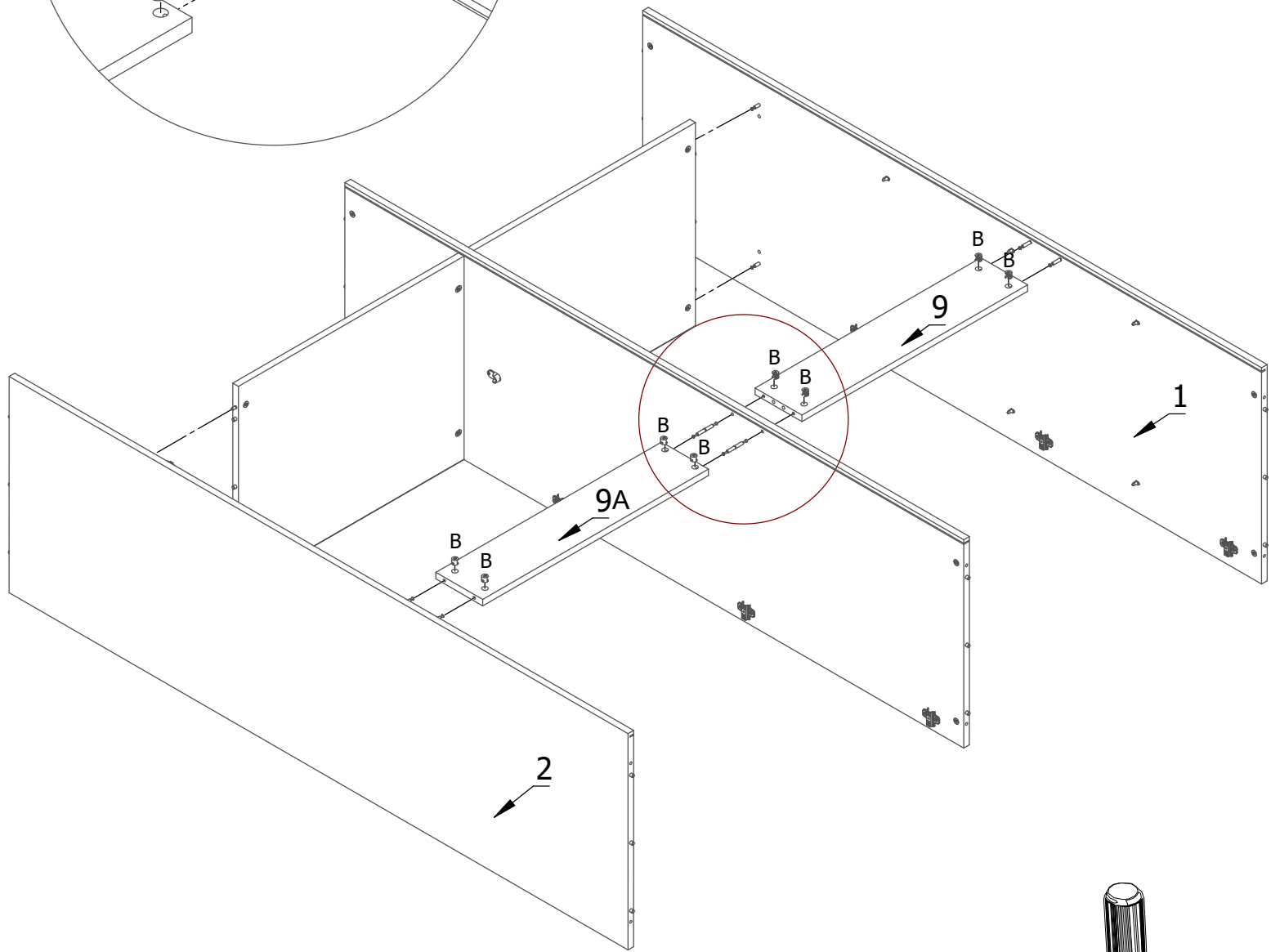
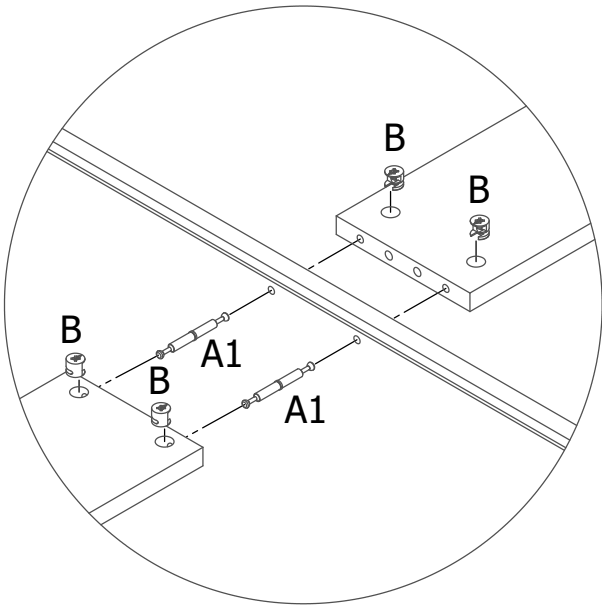

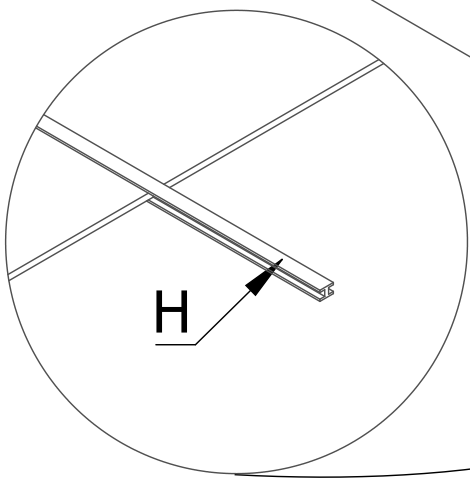
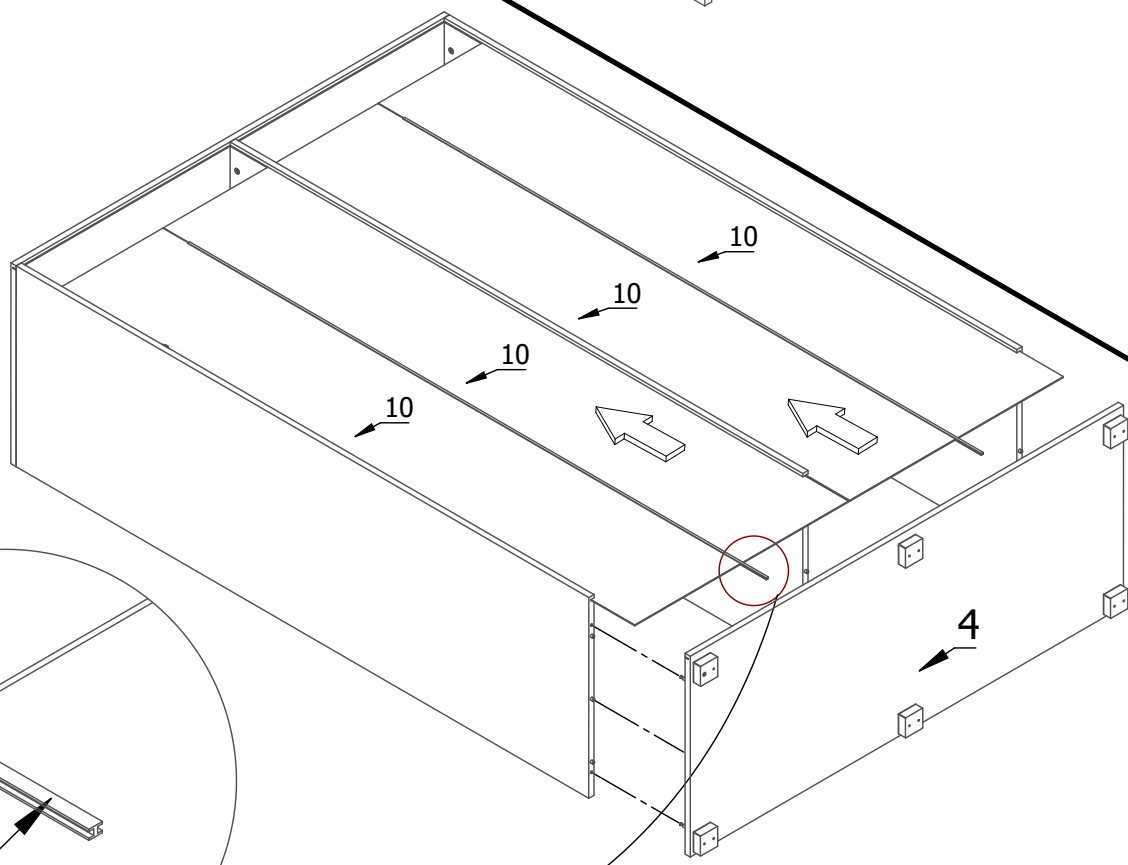
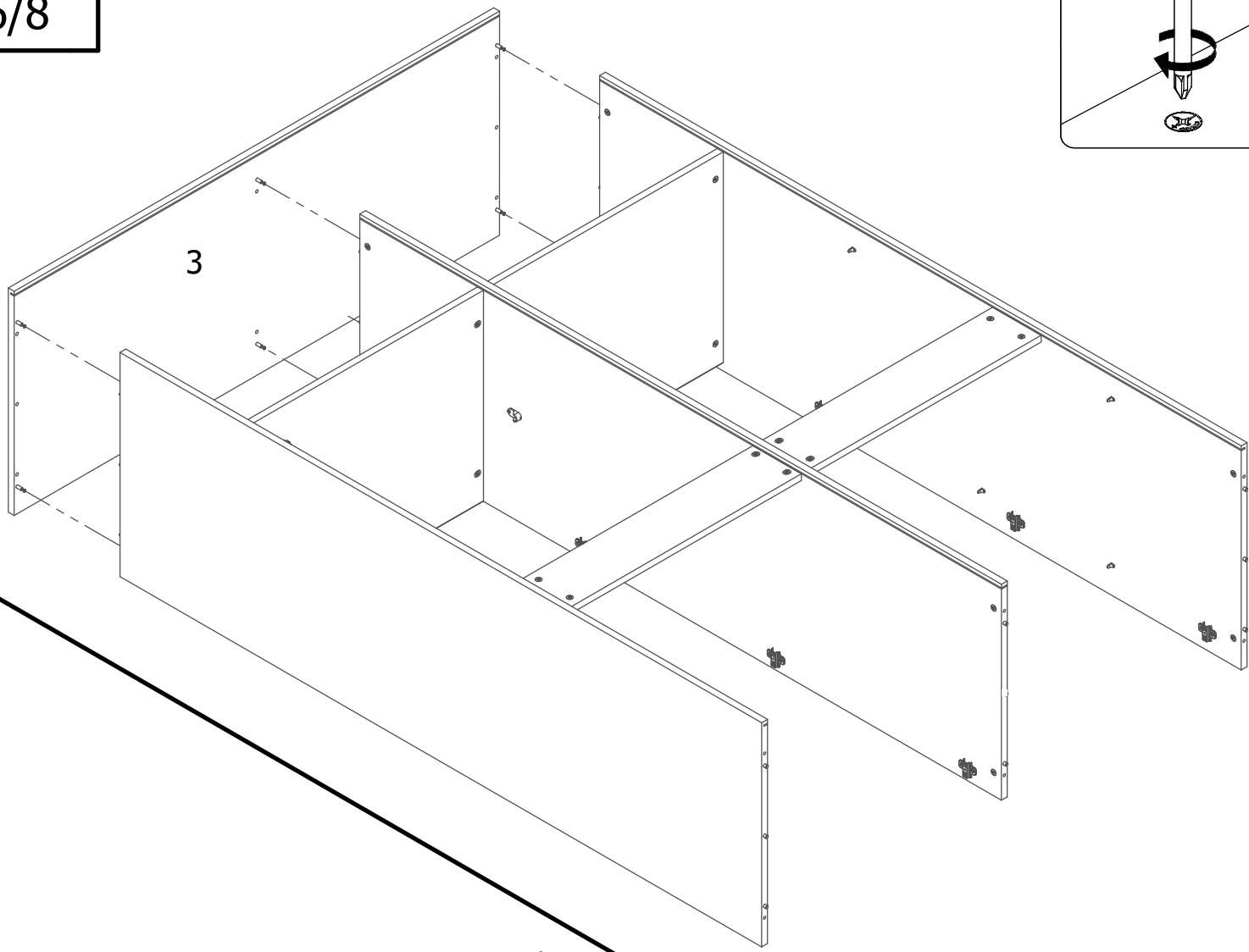
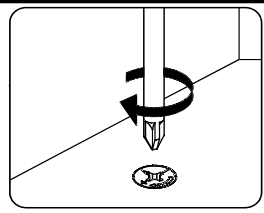

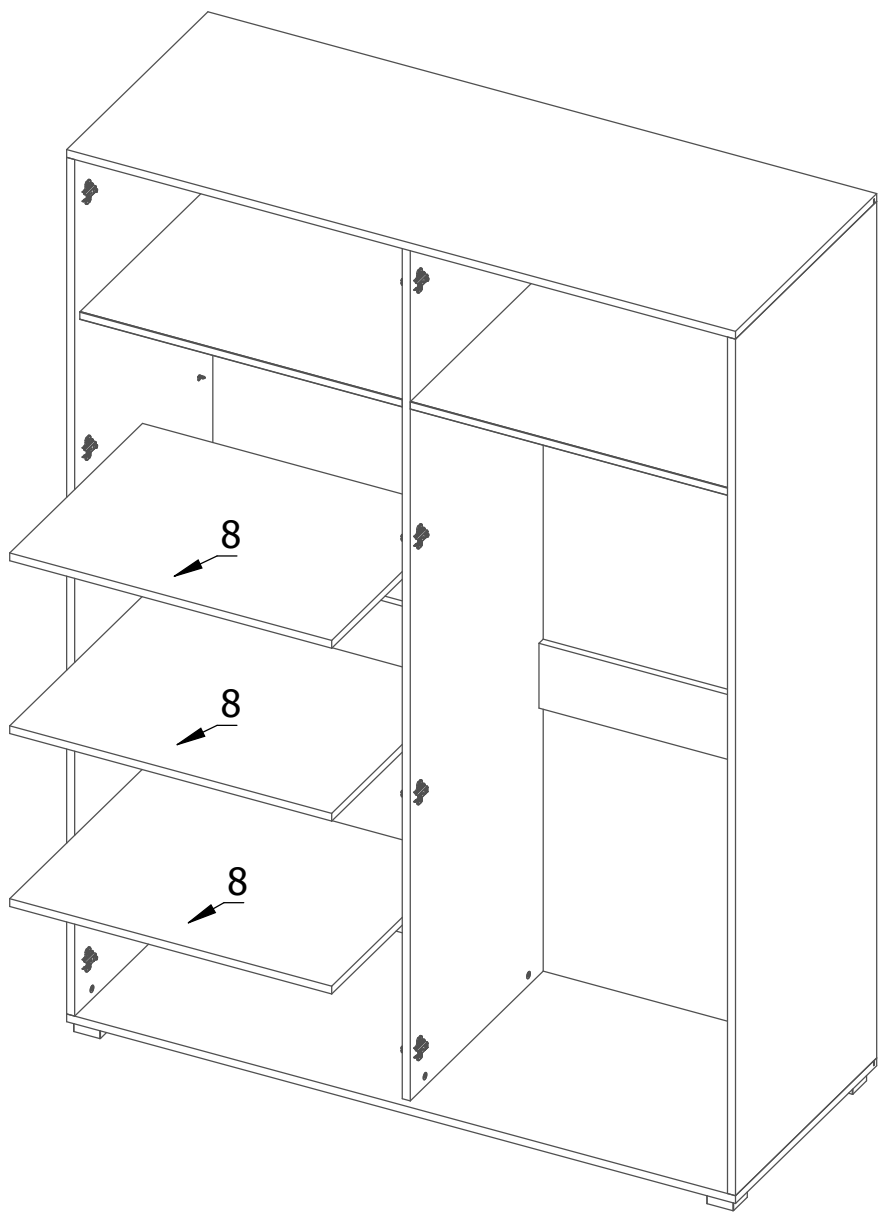
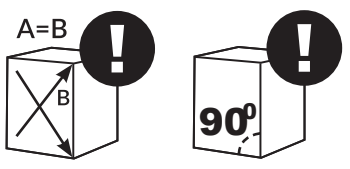
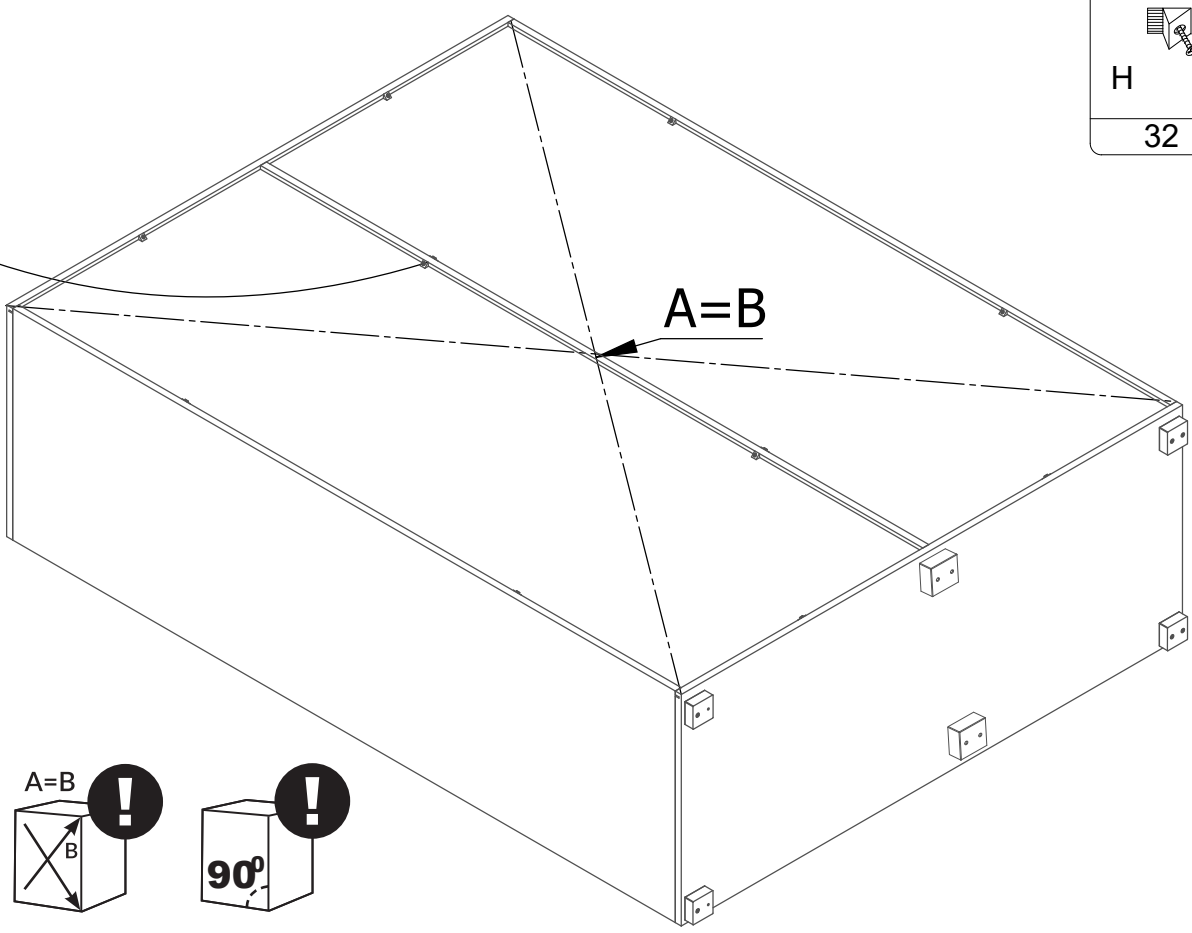
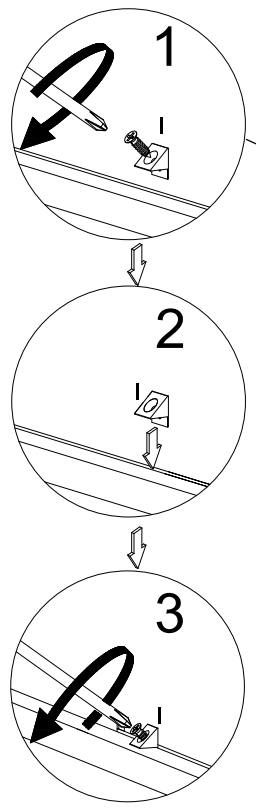

X ⊙	4x16 H1 ⌘	UM ⌘
20	4	2

