

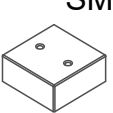





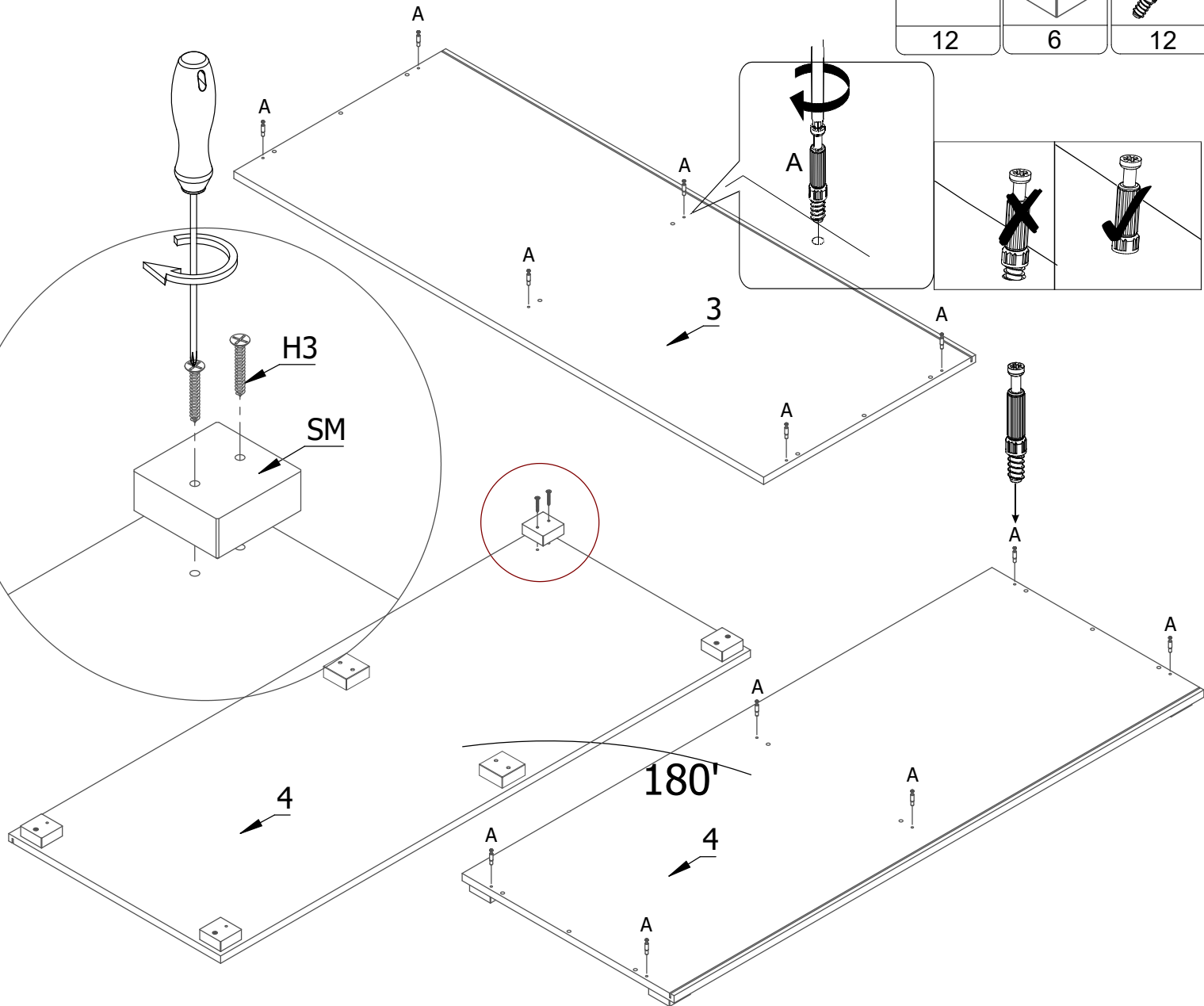

| | | | | | | | |
|--|--|--|--|--|--|--|--|
| | | | | | | | |
| | | | | | | | |

| | | |
|------------------------------------------------------------------------------------|------------------------------------------------------------------------------------|------------------------------------------------------------------------------------|
| H3 | SM | A |
|  |  |  |
| 12 | 6 | 12 |

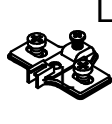

| | | | | |
|-------------------------------------------------------------------------------------|---------------------------------------------------------------------------------------|---------------------------------------------------------------------------------------|---------------------------------------------------------------------------------------|---------------------------------------------------------------------------------------|
| S | L | B | D | A |
|  |  |  |  |  |
| 6 | 4 | 4 | 6 | 4 |

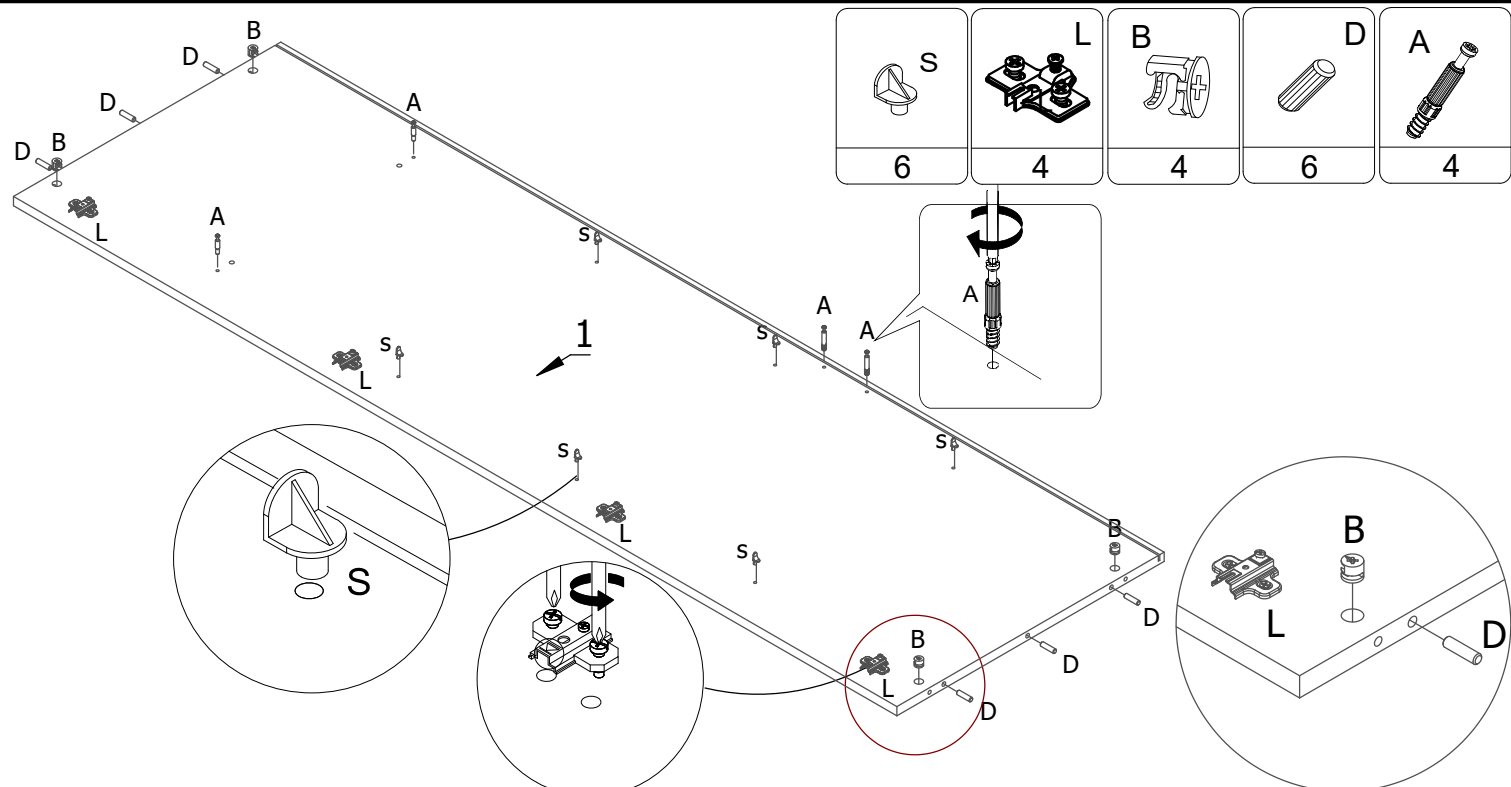

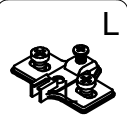
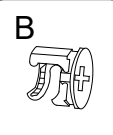
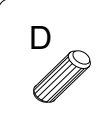
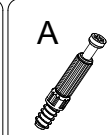
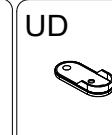
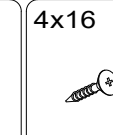
| | | | | | |
|----------------------------------------------------------------------------------|-----------------------------------------------------------------------------------|------------------------------------------------------------------------------------|------------------------------------------------------------------------------------|------------------------------------------------------------------------------------|------------------------------------------------------------------------------------|
|  |  |  |  |  |  |
| 4 | 4 | 6 | 4 | 1 | 2 |

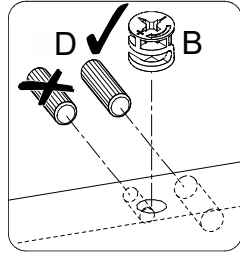
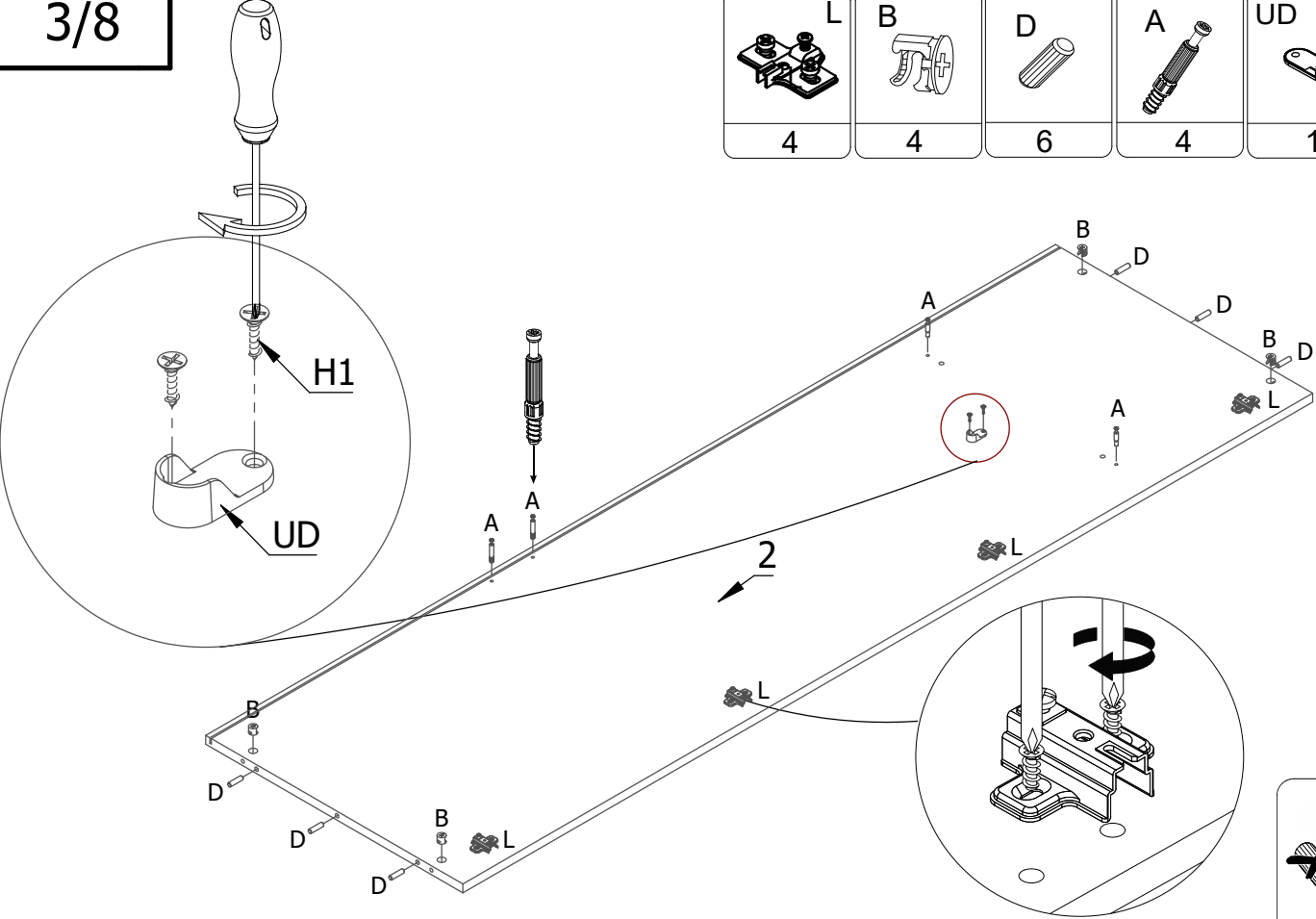

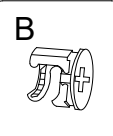
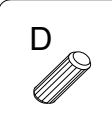
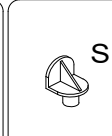
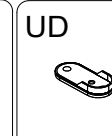
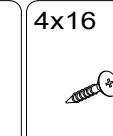
| | | | | | |
|-------------------------------------------------------------------------------------|--------------------------------------------------------------------------------------|---------------------------------------------------------------------------------------|---------------------------------------------------------------------------------------|---------------------------------------------------------------------------------------|---------------------------------------------------------------------------------------|
|  |  |  |  |  |  |
| 8 | 4 | 4 | 6 | 1 | 2 |

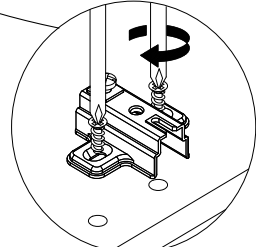
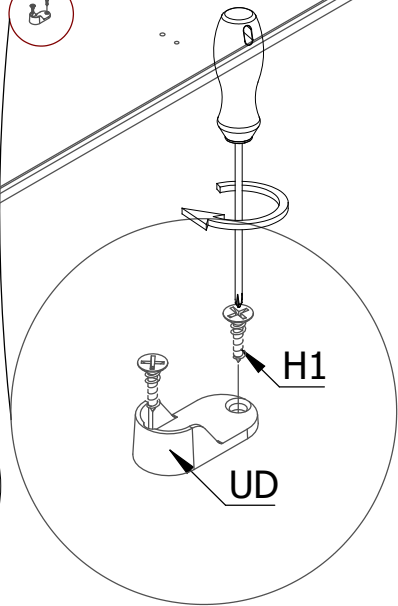
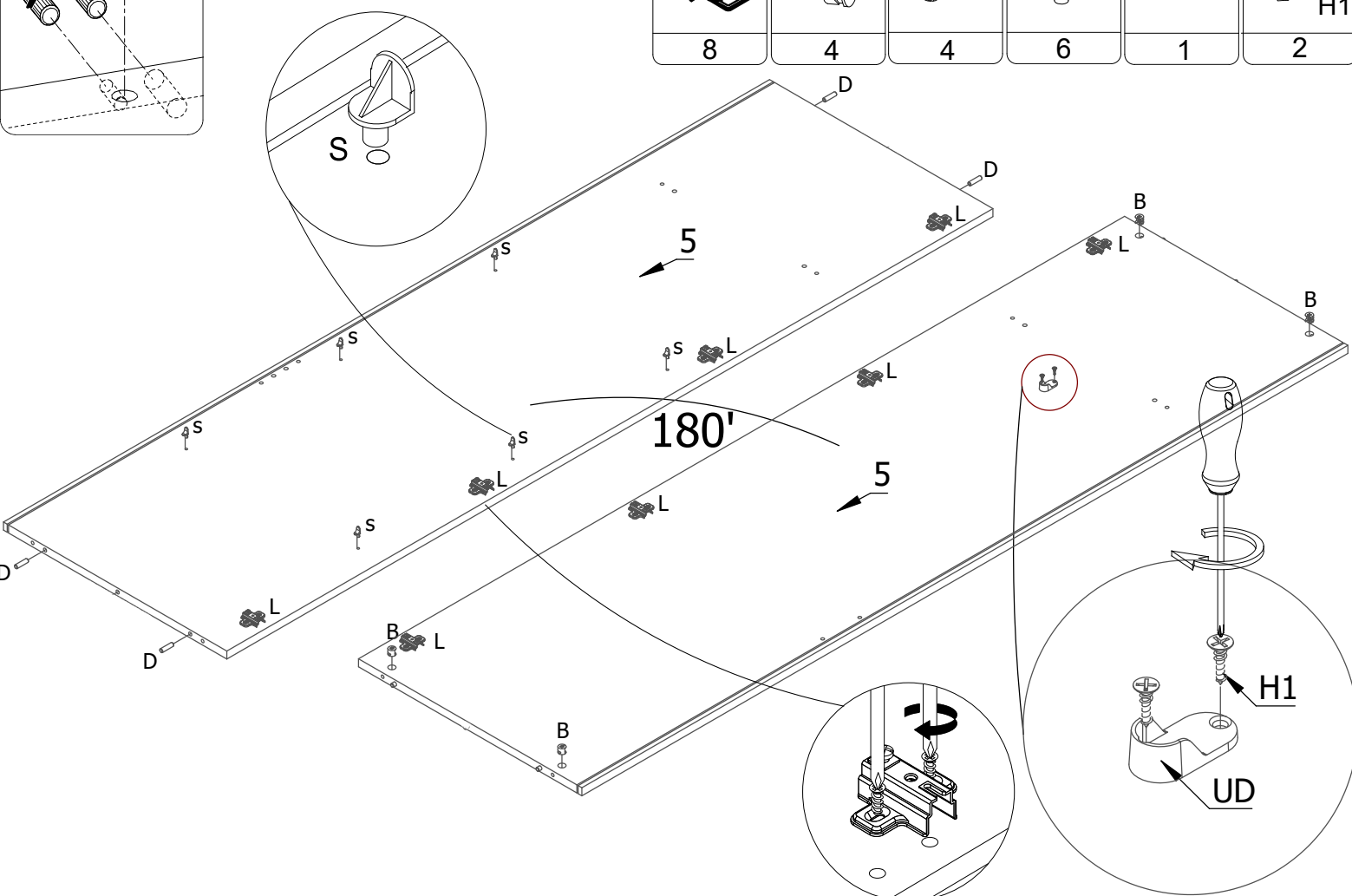
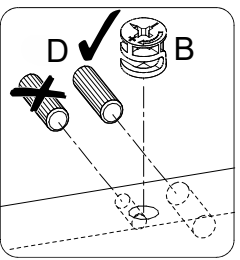

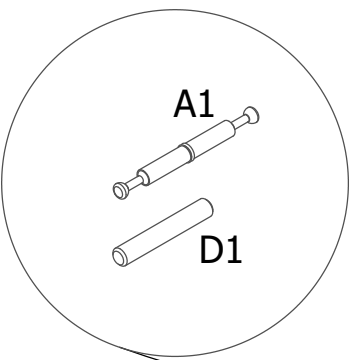
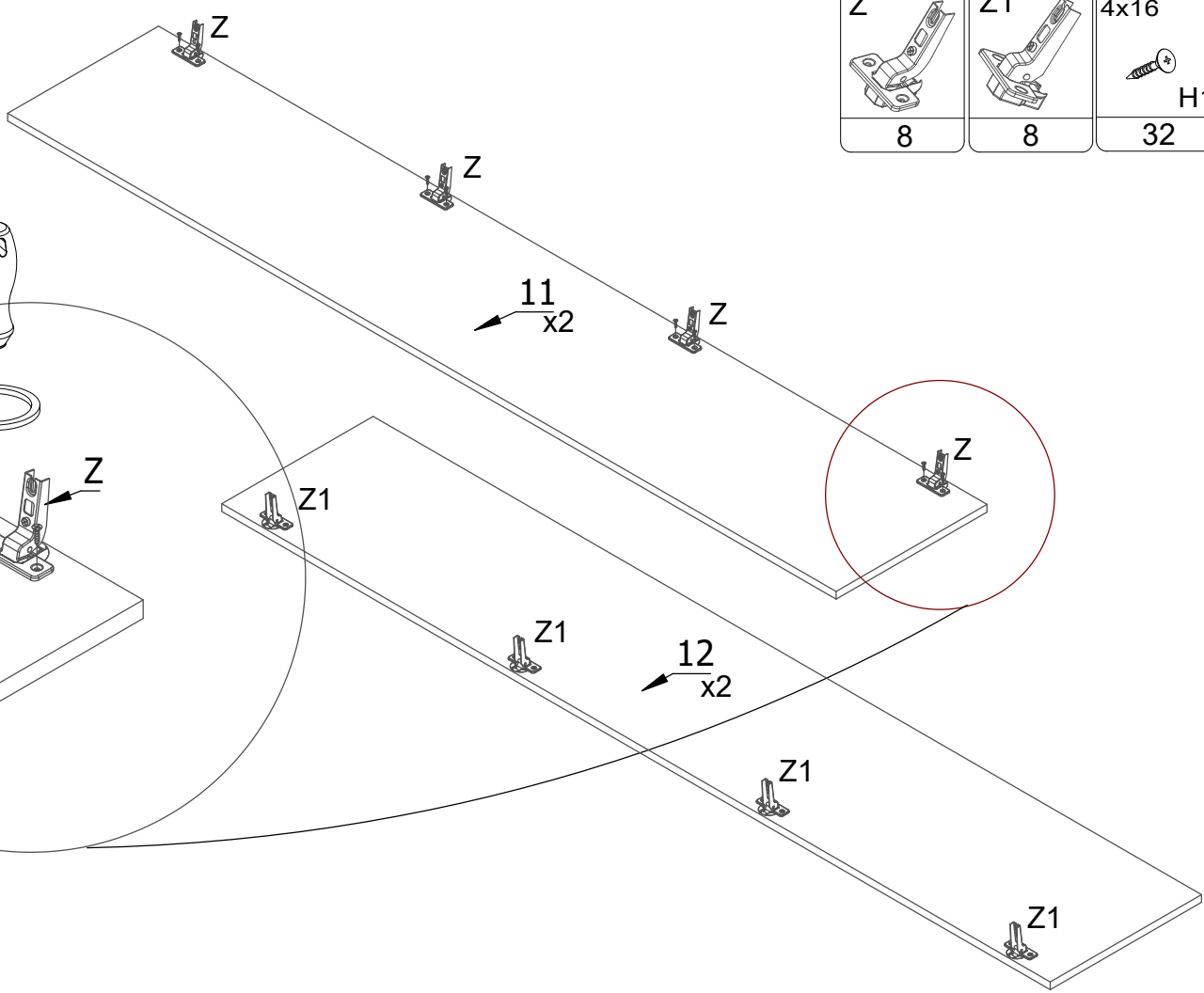
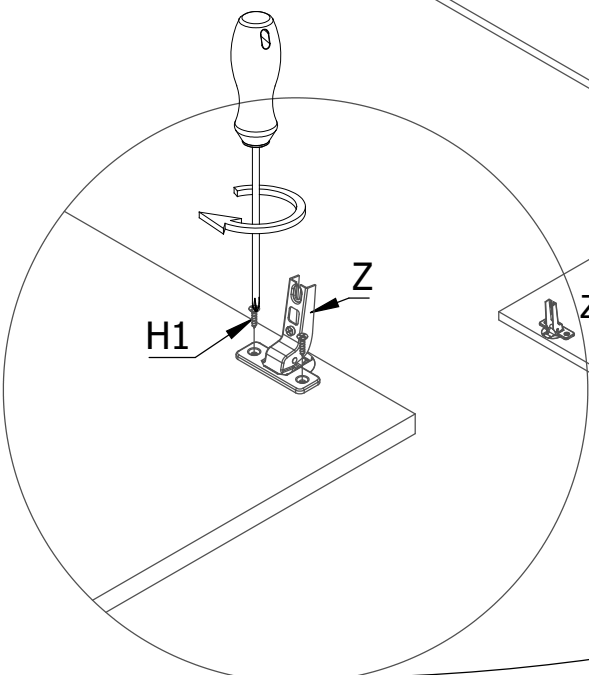

| | | |
|---|----|------|
| Z | Z1 | 4x16 |
| | | |
| 8 | 8 | 32 |
| | | H1 |

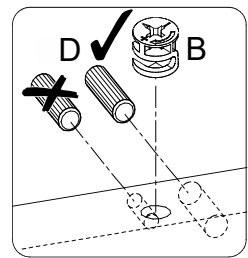
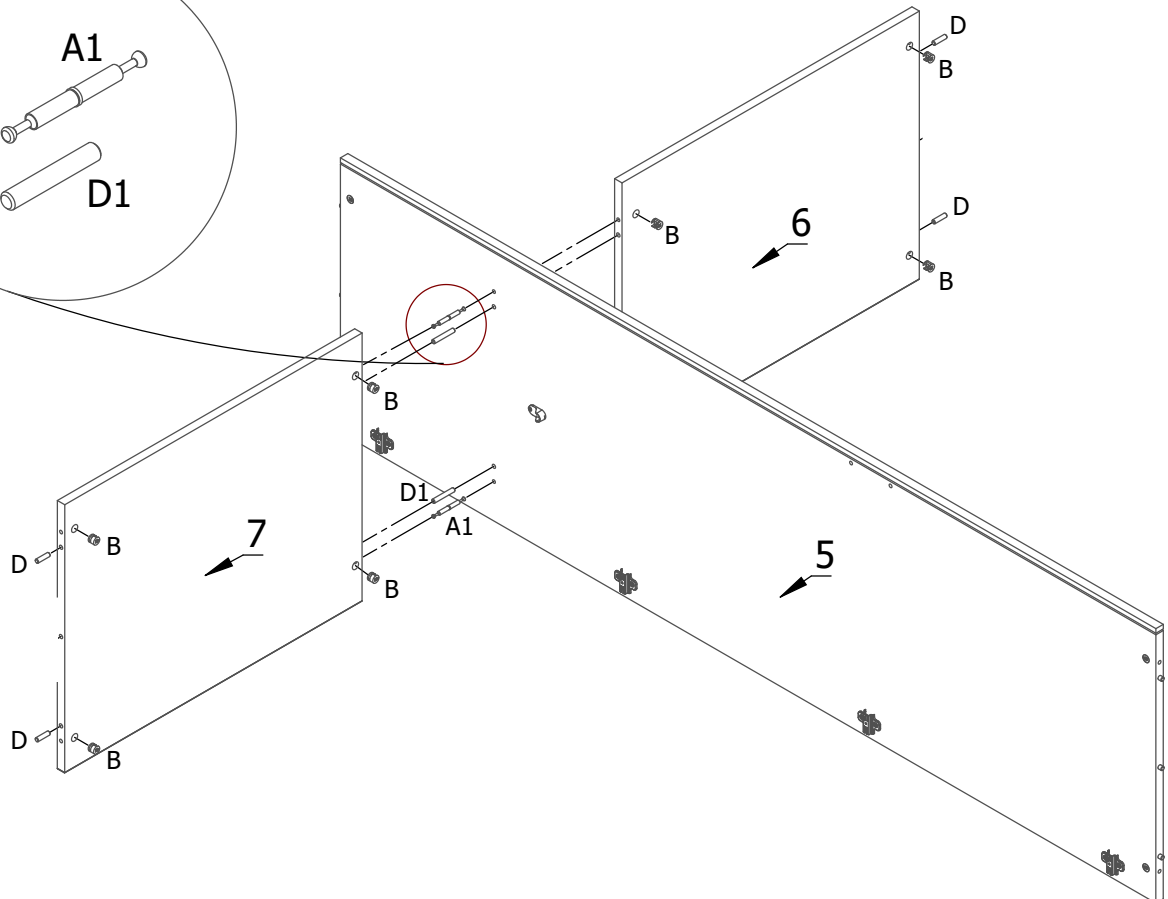

| | |
|----|--------|
| D | 8.0x45 |
| | |
| 4 | 2 |
| A1 | B |
| | |
| 2 | 8 |



| | |
|------------------------------------------------------------------------------------|------------------------------------------------------------------------------------|
| A1 | B |
|  |  |
| 2 | 8 |

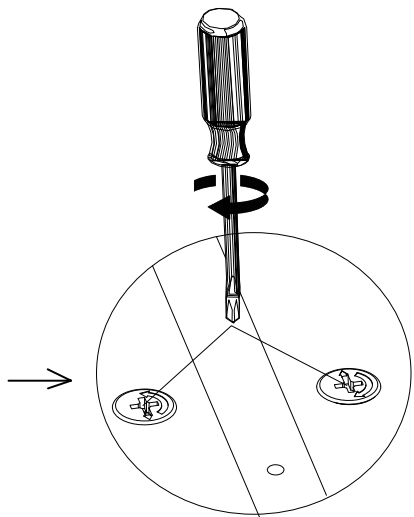
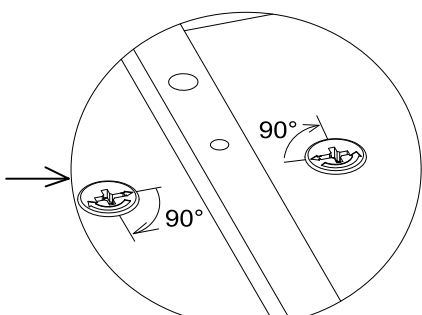
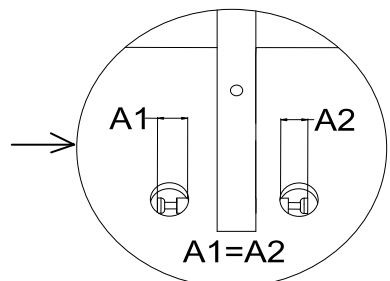
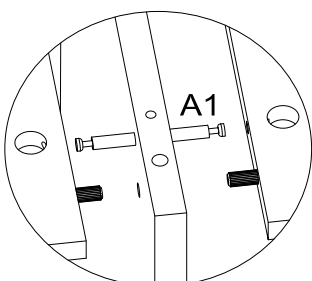
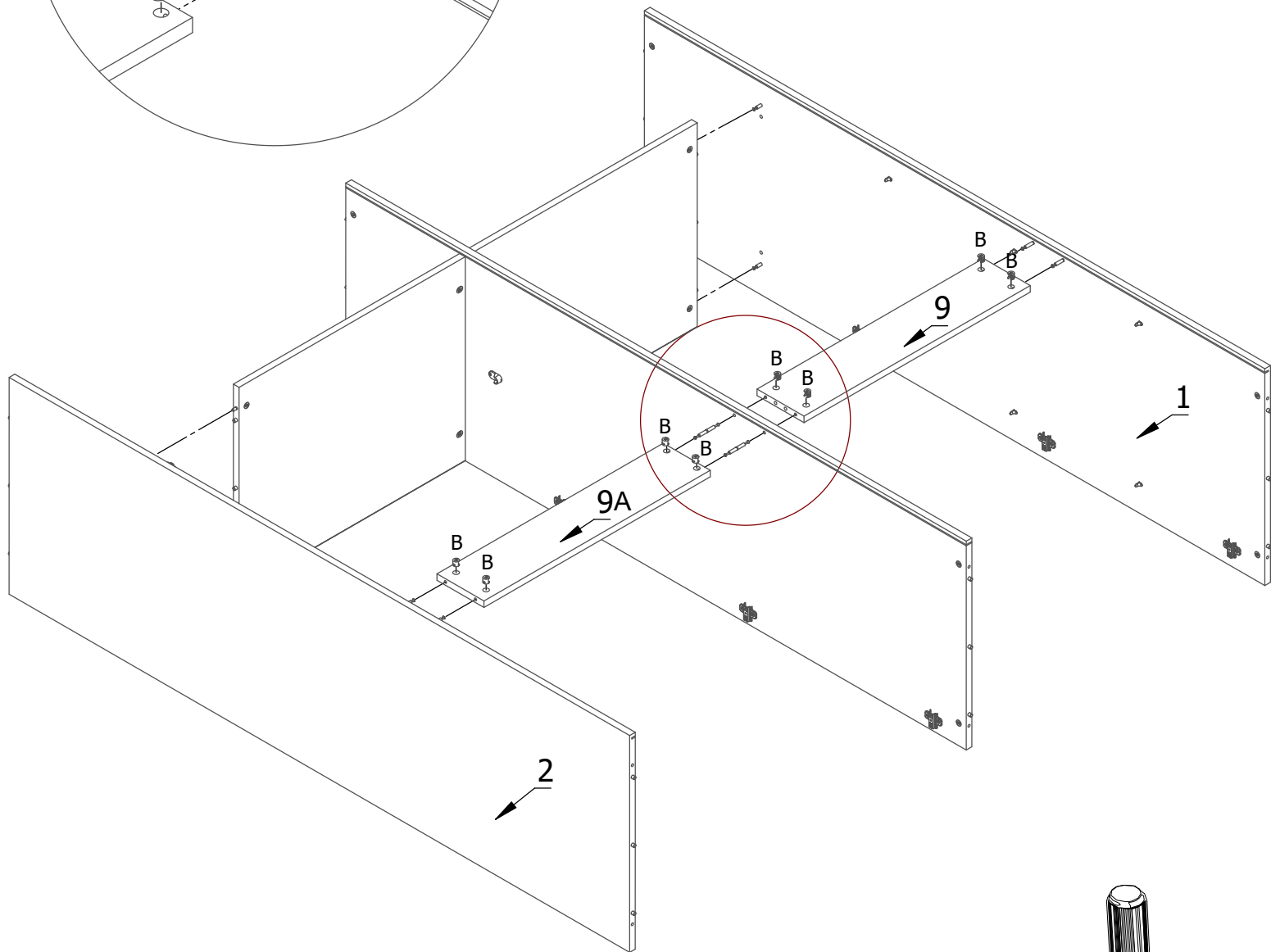
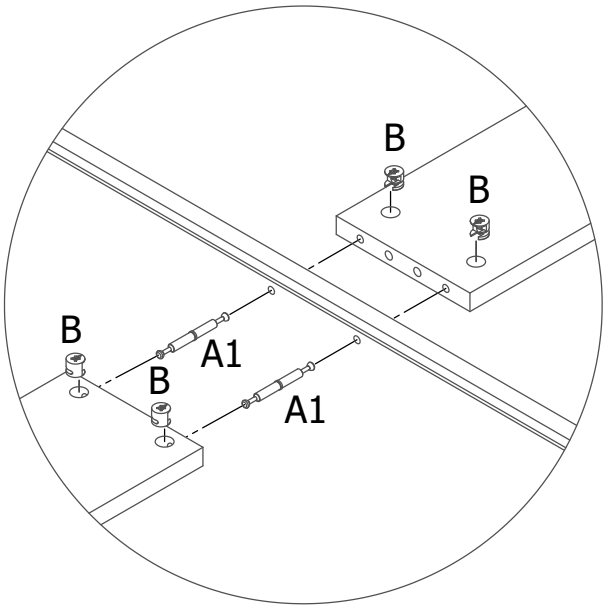

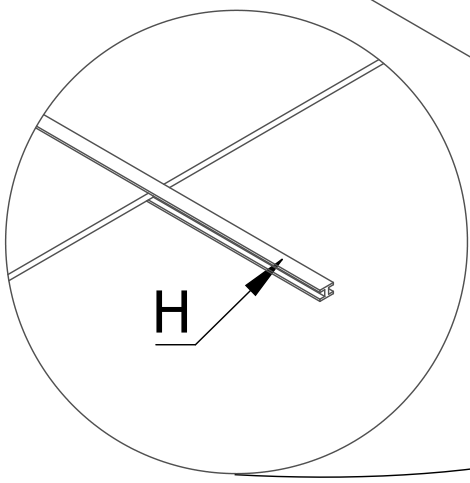
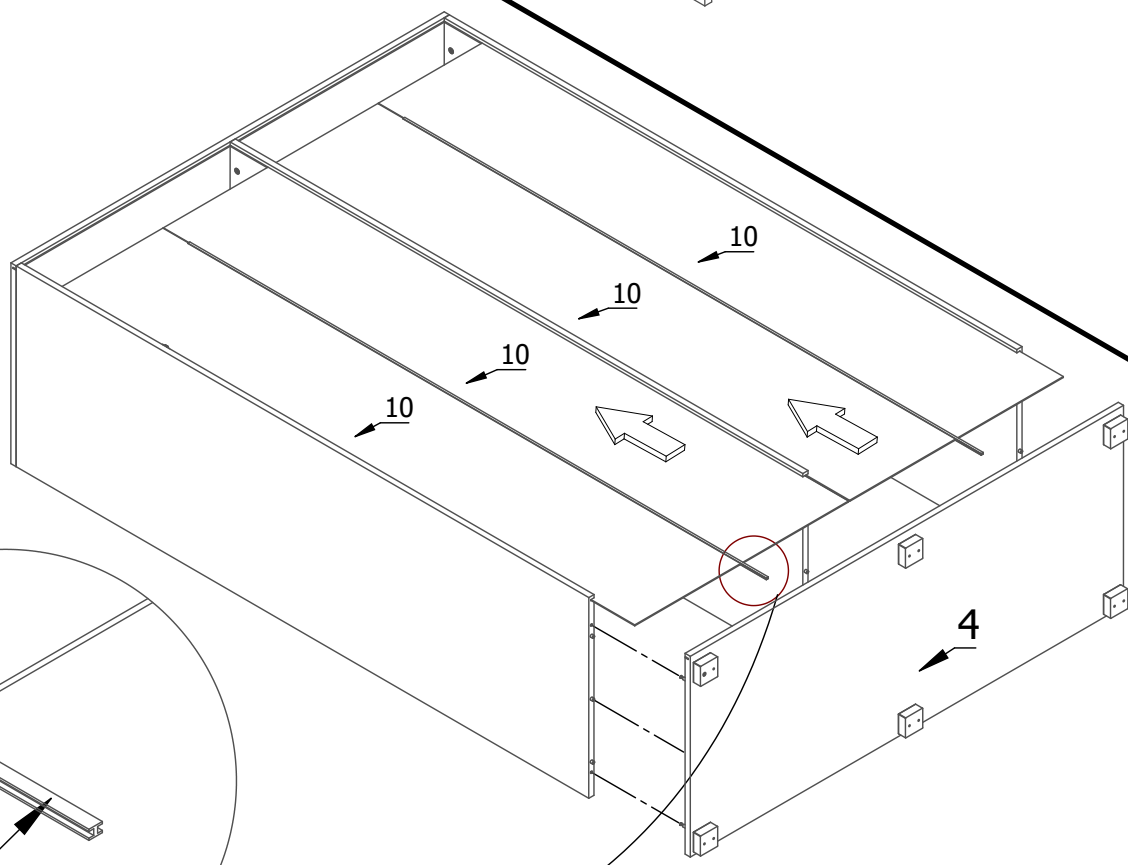
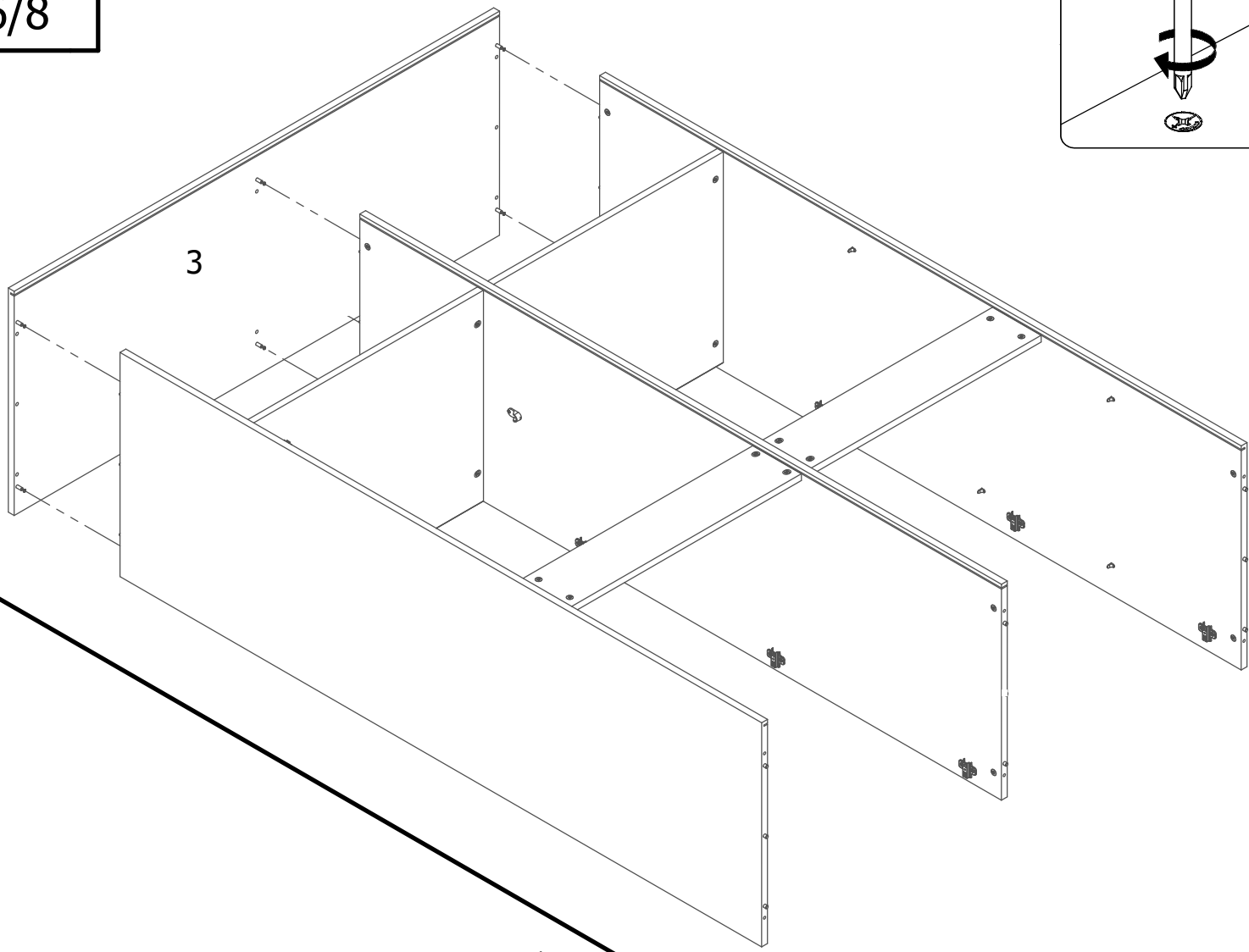
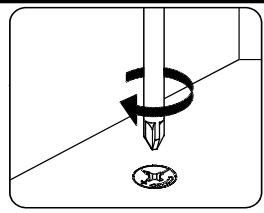

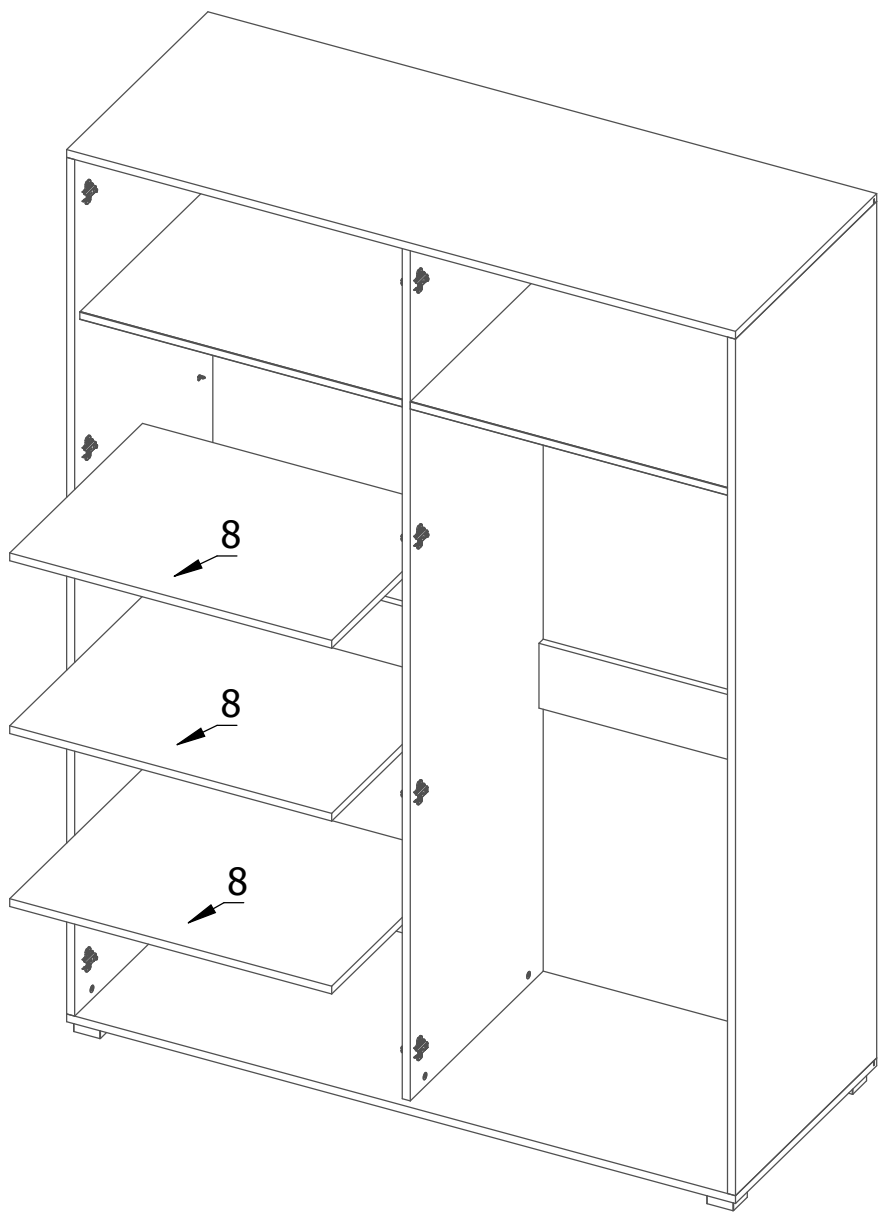
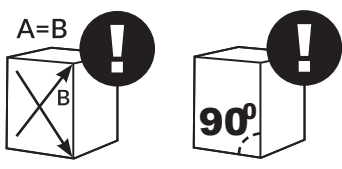
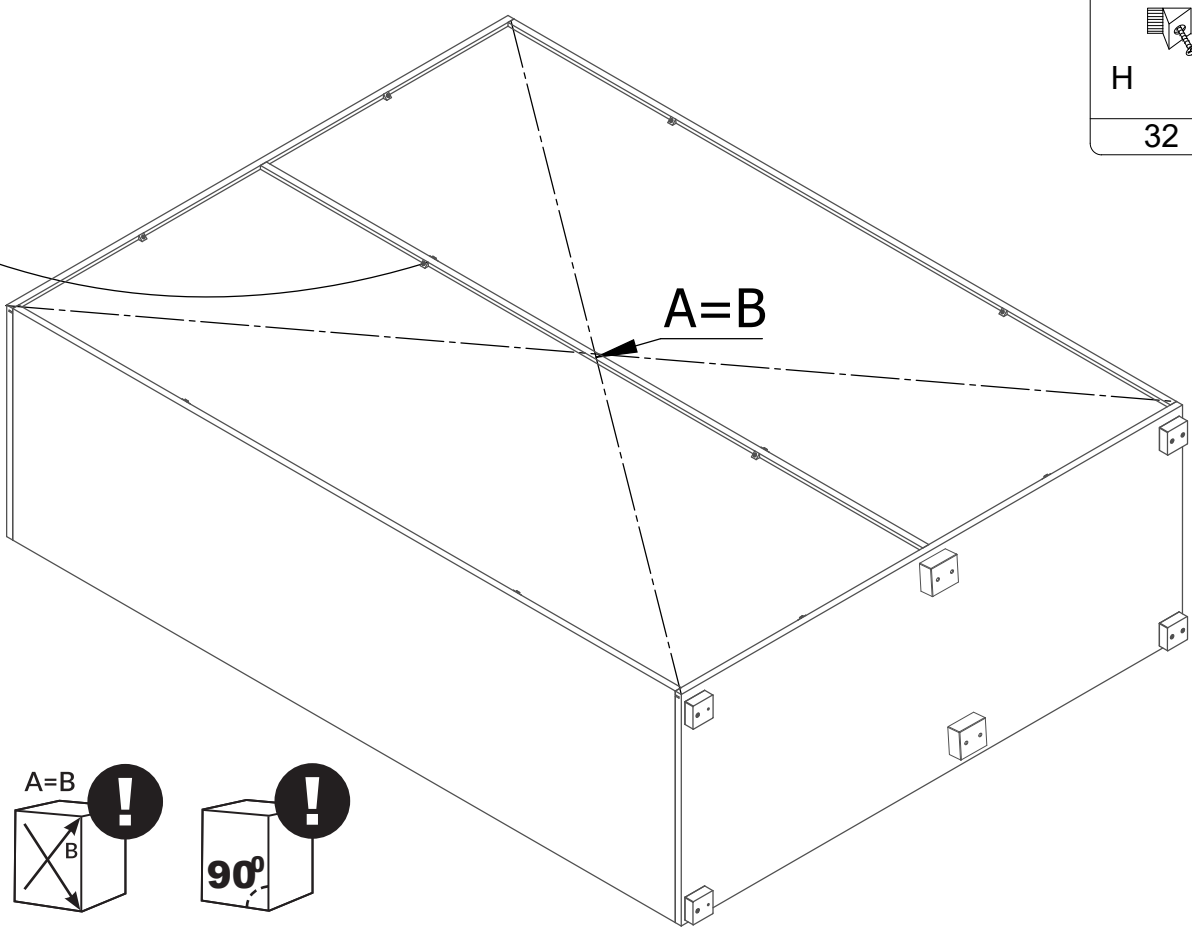
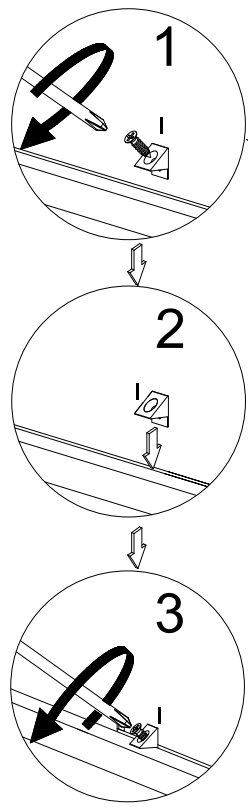

| | | |
|--------|-----------------|---------|
| X ⊙ | 4x16 H1 ⚙ | UM ⌋ |
| 20 | 4 | 2 |

