

JELLY TYP 31

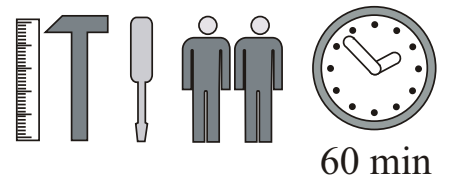
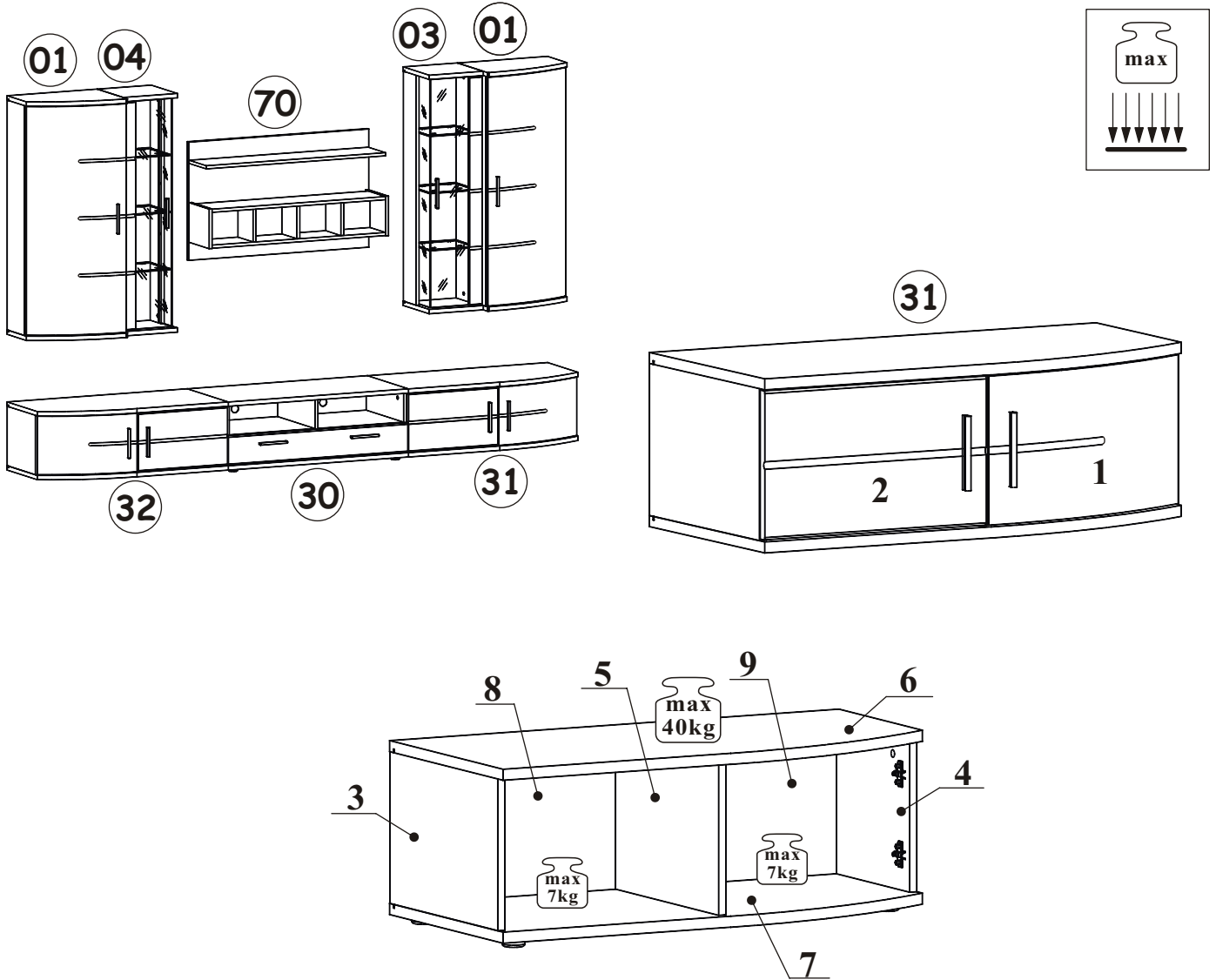

| NO | Dim. | | Col.-No | Qty |
|----|------|-----|---------|-----|
| 1 | 504 | 296 | 1 | 1 |
| 2 | 496 | 296 | 1 | 1 |
| 3 | 302 | 457 | 1 | 1 |
| 4 | 302 | 330 | 1 | 1 |
| 5 | 302 | 437 | 1 | 1 |
| 6 | 1001 | 480 | 1 | 1 |
| 7 | 1001 | 480 | 1 | 1 |
| 8 | 314 | 490 | 1 | 1 |
| 9 | 314 | 490 | 1 | 1 |

JELLY TYP 31

| | | | | | |
|-------------------------|------------------------|-------------------------|-----------------------|----------------------|-----------|
| A1 X12 ø8x36 | B4 X6 | B5 X6 ø15x12 | G5 X6 | B11 X6 Ø7x50 | G4 X6 |
| E21 X4 Ø35 H=0 | E2 X4 H=0 | D10 X10 USØ3,5x13 | KL X2 L-128mm | UP6 X4 UPØ4x30 | S1 X10 |
| I11 X5 | D11 X5 USØ3,5x25 | G16 X3 | UP13 X3 UPØ3x16 | L1 X1 | KR1 X1 |
| G2 X1 | | | | | |

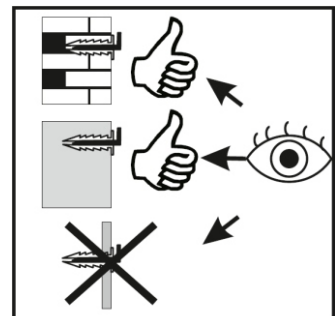
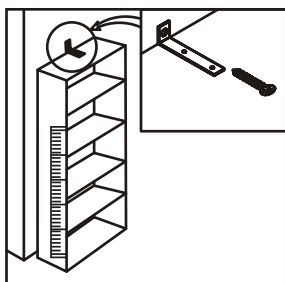
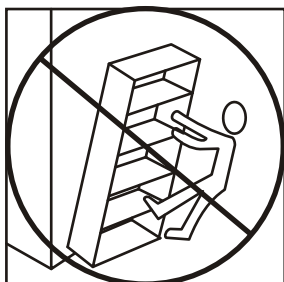
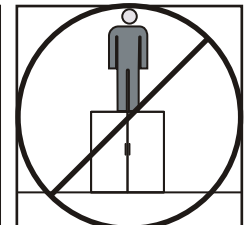
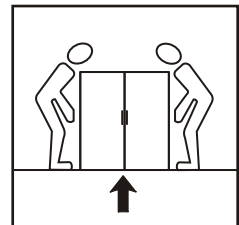
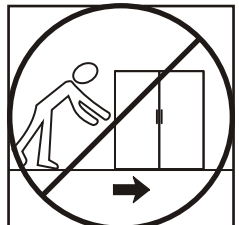
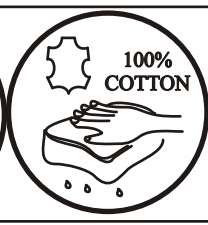
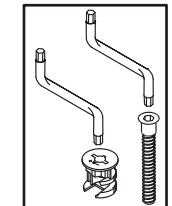
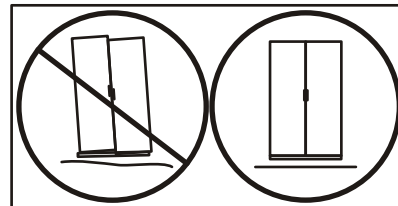
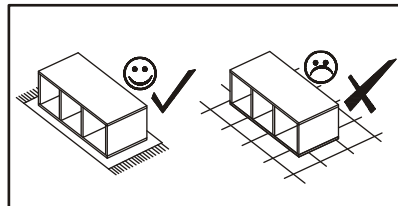
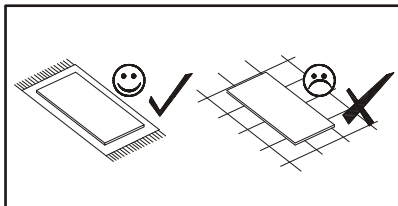
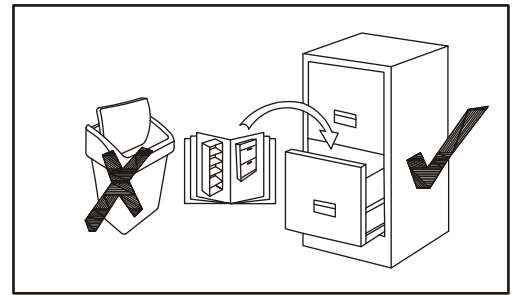
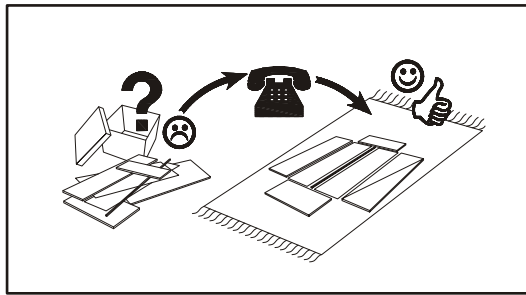
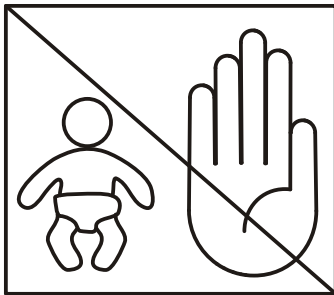
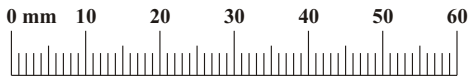

JELLY TYP 31

1

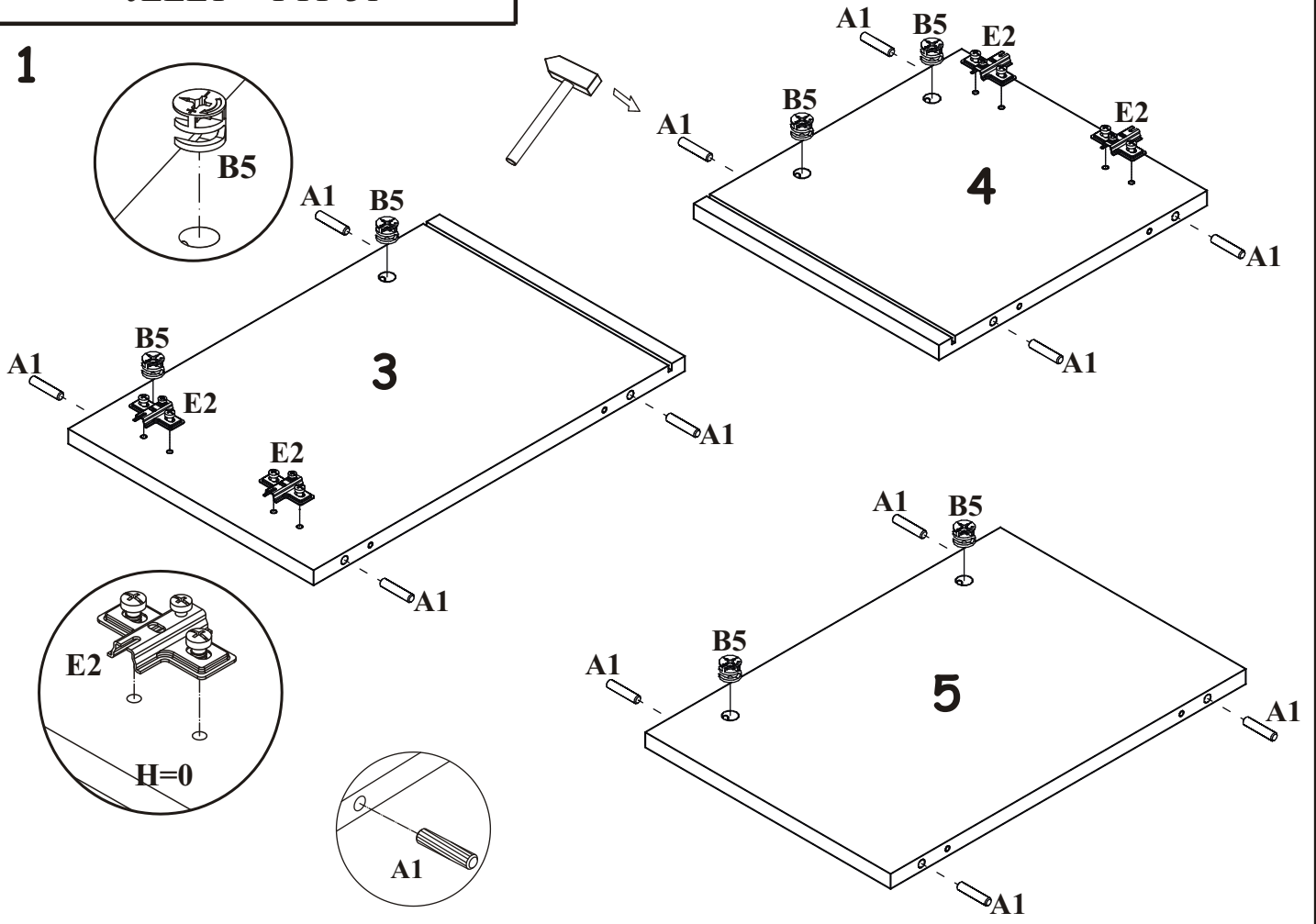

2

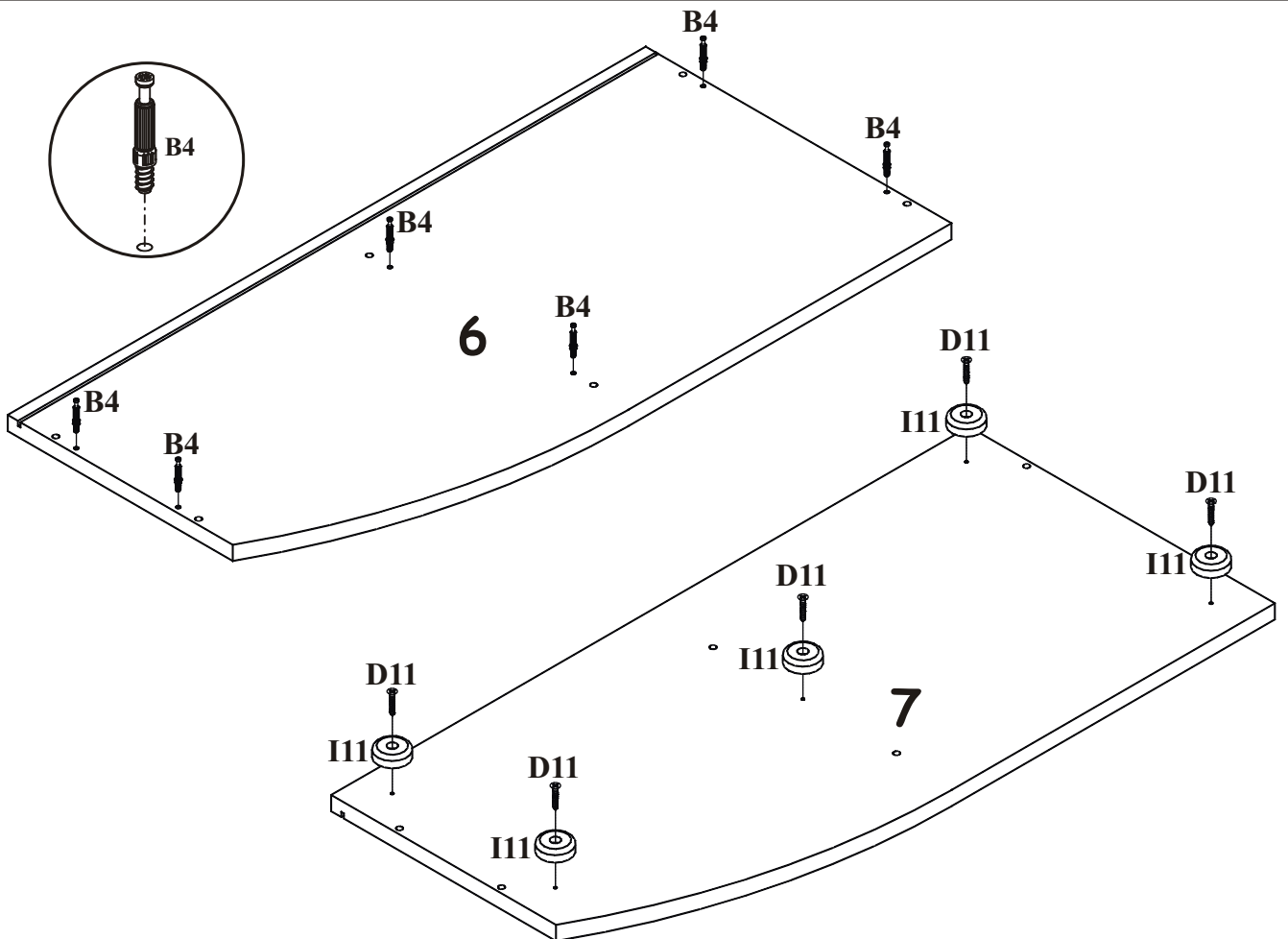

JELLY TYP 31

3

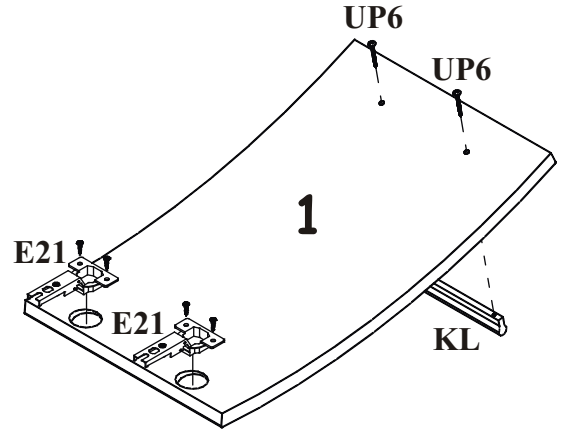
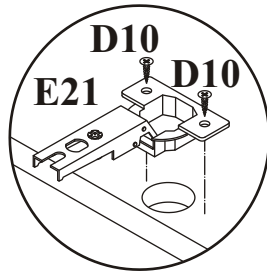
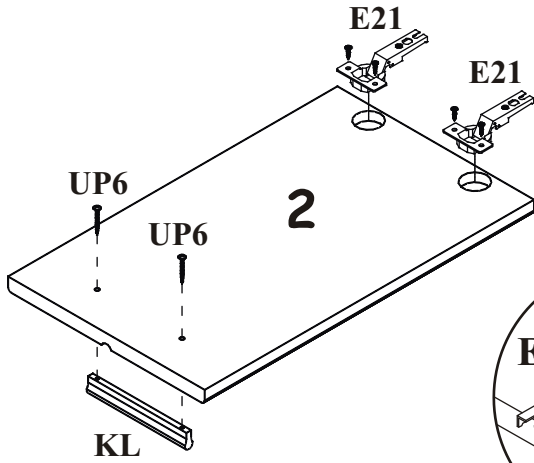
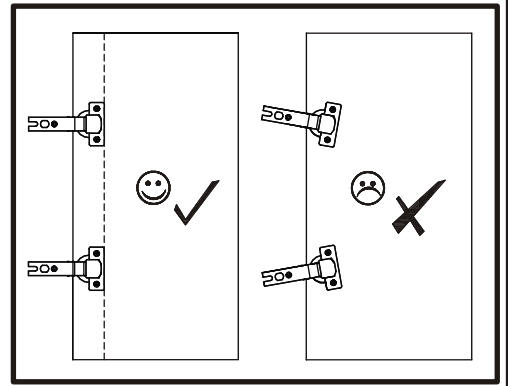
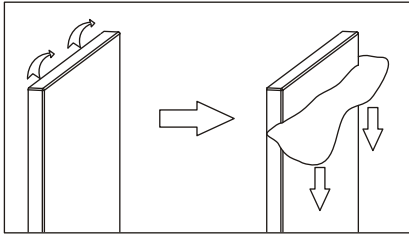

4

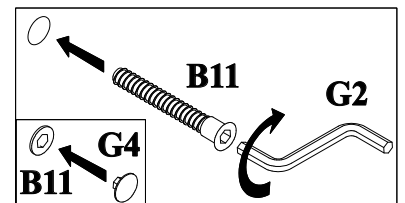
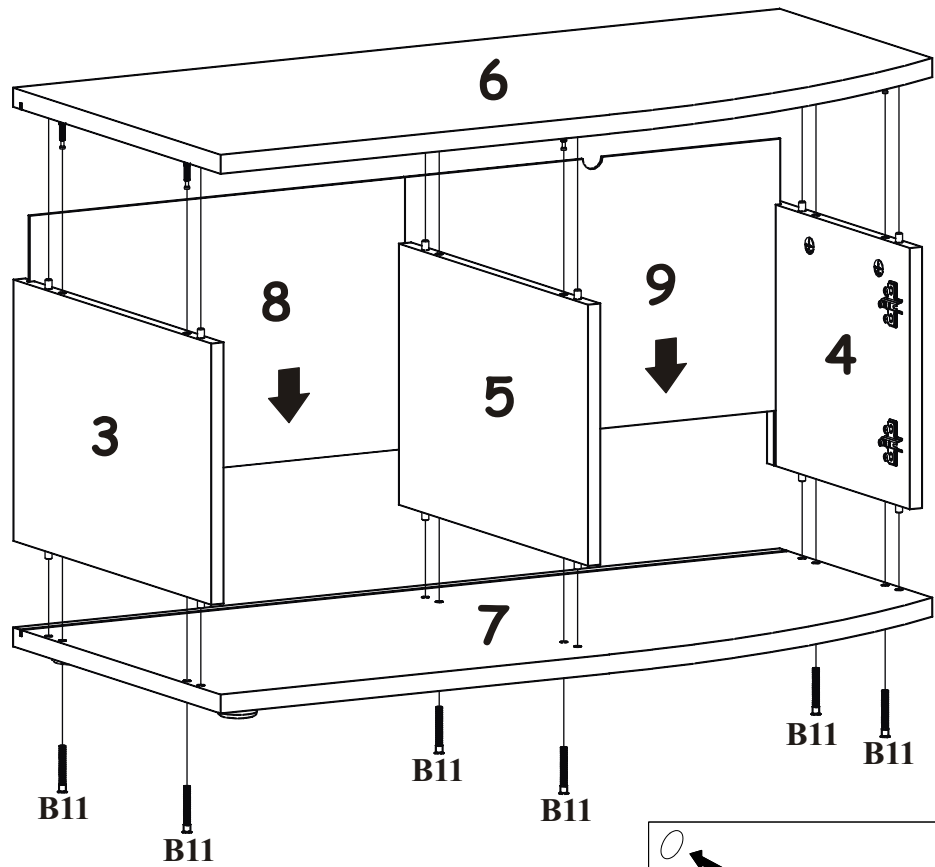
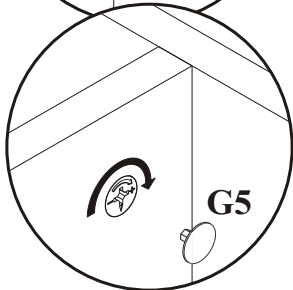
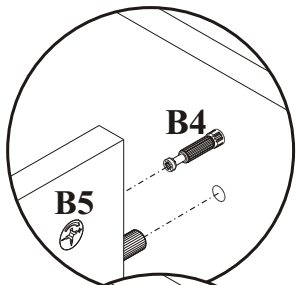

5

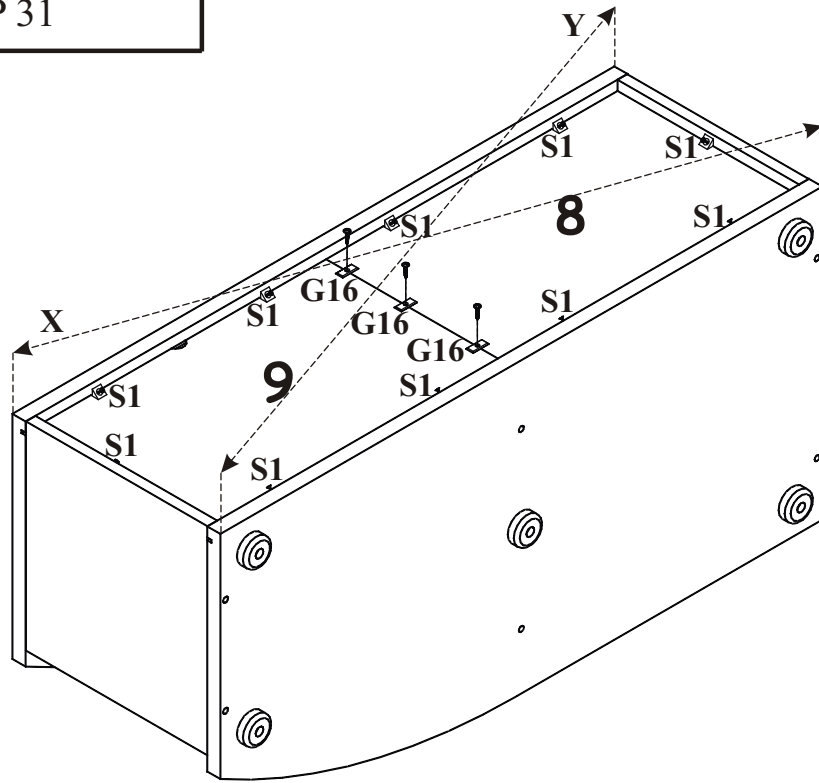
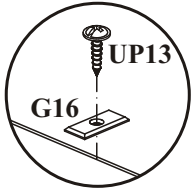
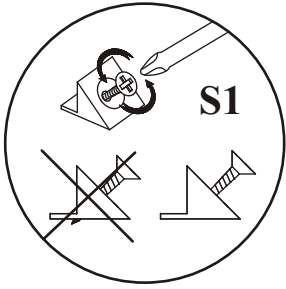

6

