

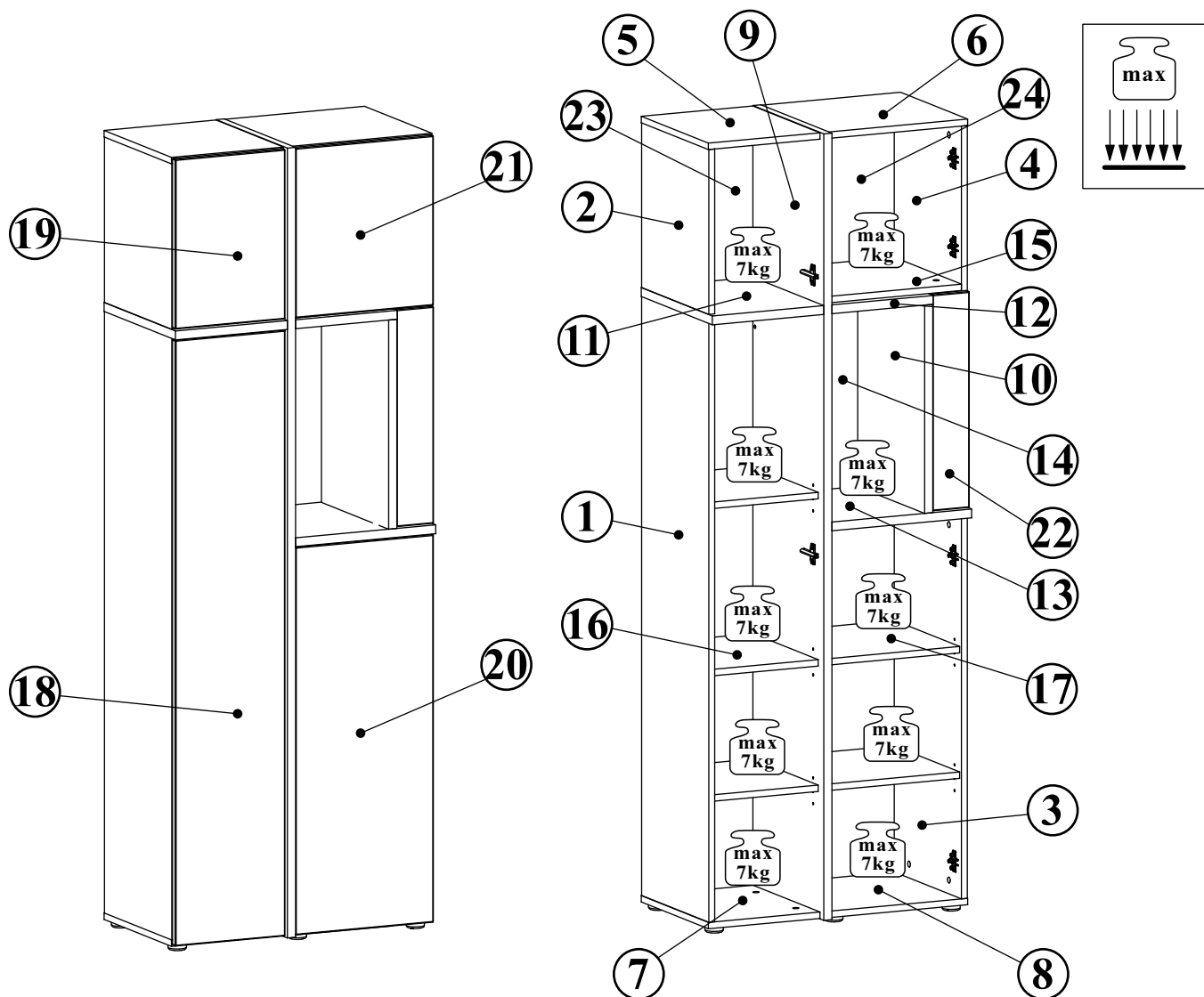

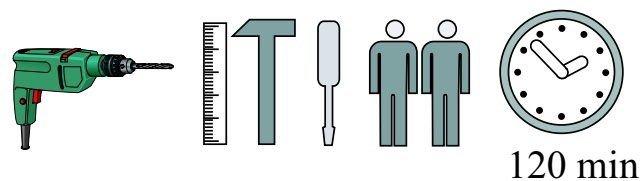





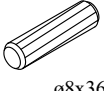
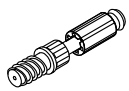

CROSS 28 ** CS WSW

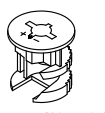
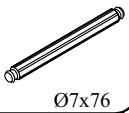
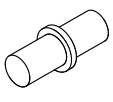
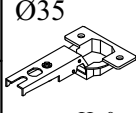
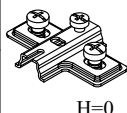
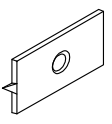
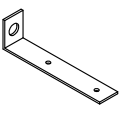
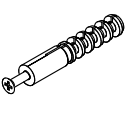
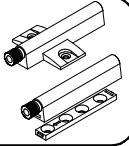
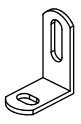
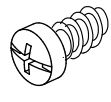

NO	Dim.			Qty	Qty
1	1490	377	16	3	1
2	410	377	16	3	1
3	950	377	16	3	1
4	950	377	16	3	1
5	302	377	16	1	1
6	378	377	16	1	1
7	302	377	16	1	1
8	378	377	16	1	1
15	361	377	16	1	1
16	285	367	16	1	3
17	361	367	16	1	2
9	1956	399	22	3	1
10	518	399	22	1	1
11	302	399	22	1	1
12	274	399	22	1	1
13	378	399	22	1	1
14	250	517	22	1	1
18	1500	296	16	2	1
19	420	296	16	2	1
20	960	372	16	2	1
21	420	372	16	2	1
22	537	100	16	2	1
23	1948	309	3	2	1
24	1948	385	3	2	1



CROSS 28 ** CS WSW

A1 x38  ø8x36	B4 x14 	B5 x28  ø15x12	G5 x34 	B15 x8  Ø7x60	G4 x8 
B16 x6  Ø15x16	B6 x10  Ø7x76	G7 x22 	E21 x9  Ø35 H=0	E2 x9  H=0	G16 x13 
L1 x2 	KR1 x2 	T3/T5 x4 	L6 x3 	D31 x6  EKØ6,3x13	UP13 x54  UPØ3x16
D10 x30  USØ3,5x13	UP15 x6  UPØ4x25	I11 x6  Ø45, h=15	G2 x1 		

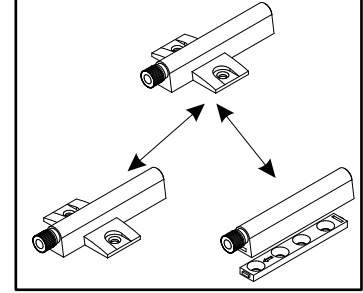
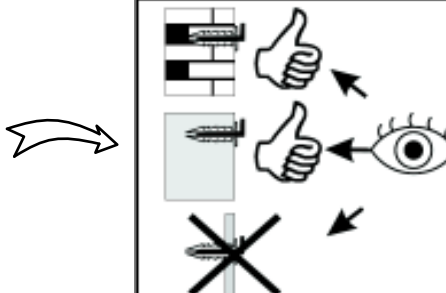
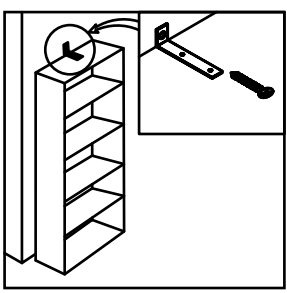
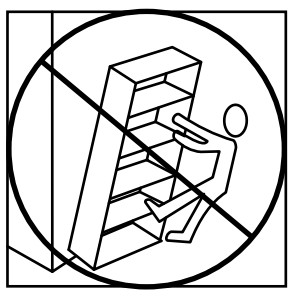
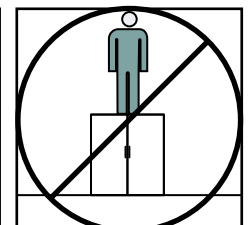
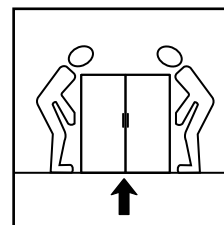
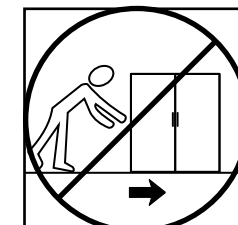
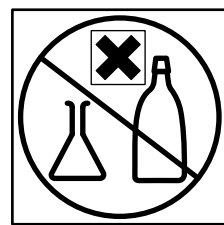
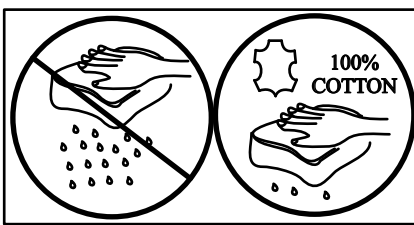
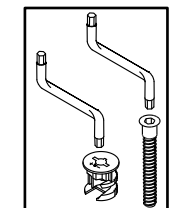
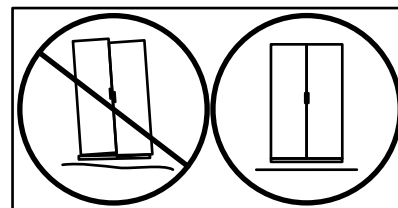
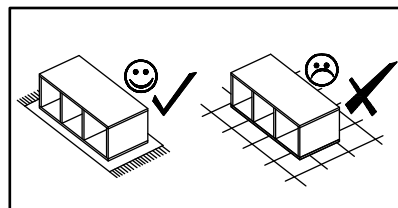
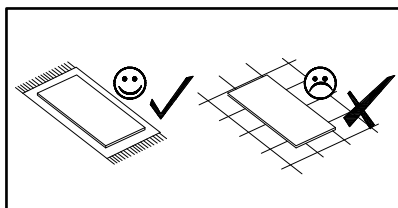
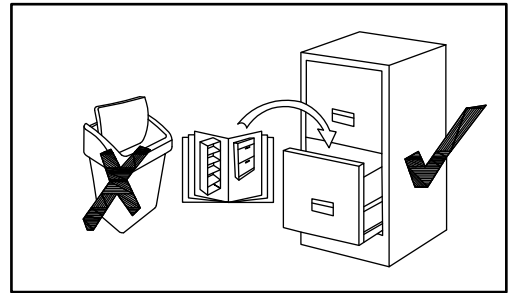
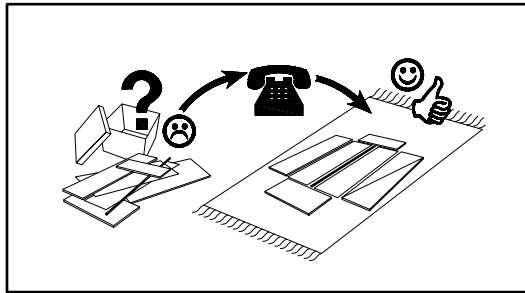
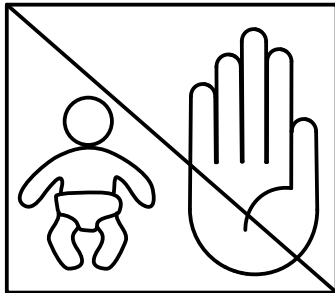
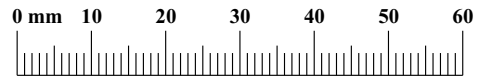

CROSS 28 ** CS WSW

1

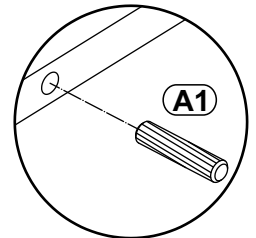
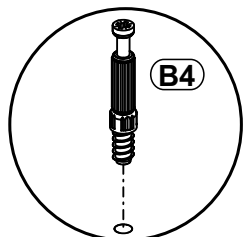
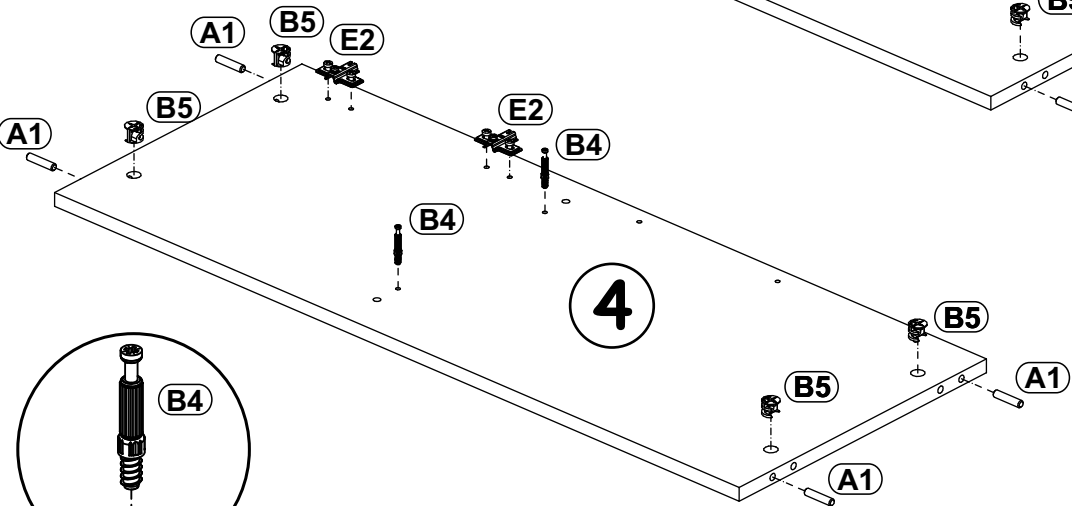
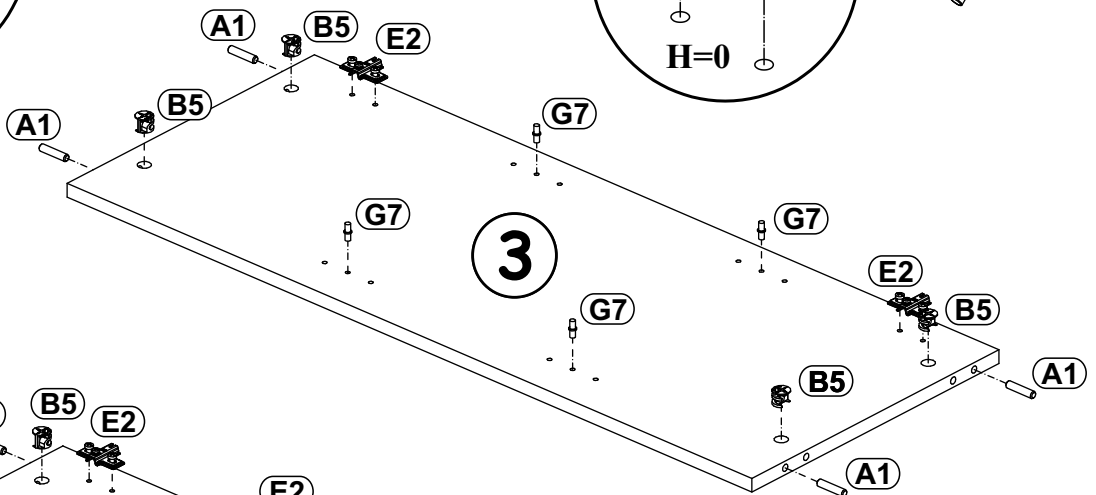
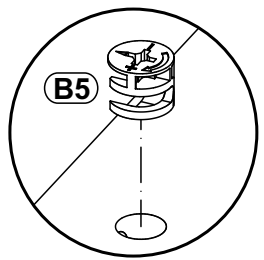
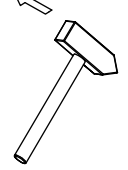
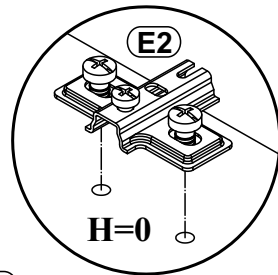
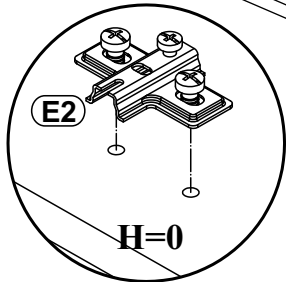
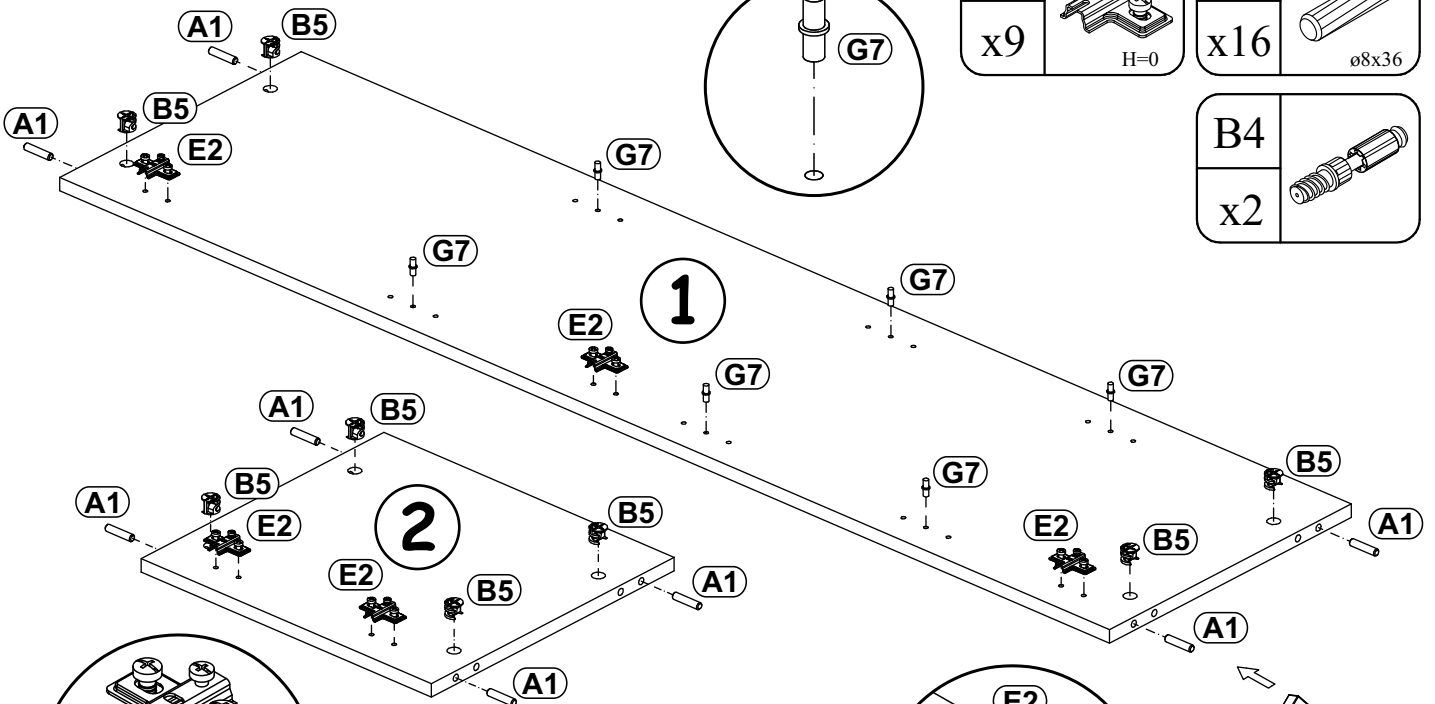
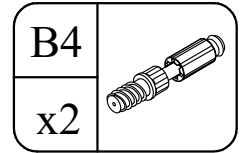
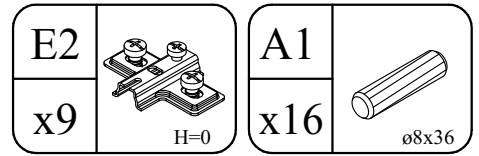
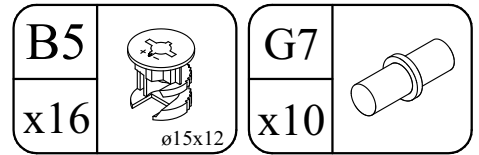
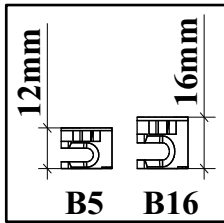

CROSS 28 ** CS WSW

2

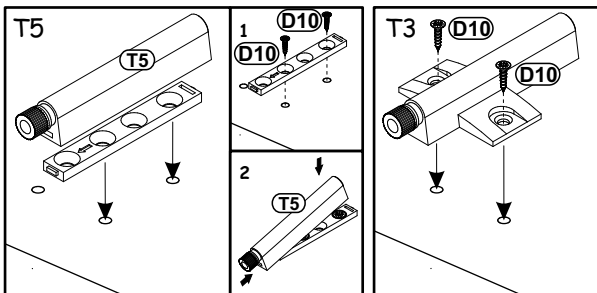
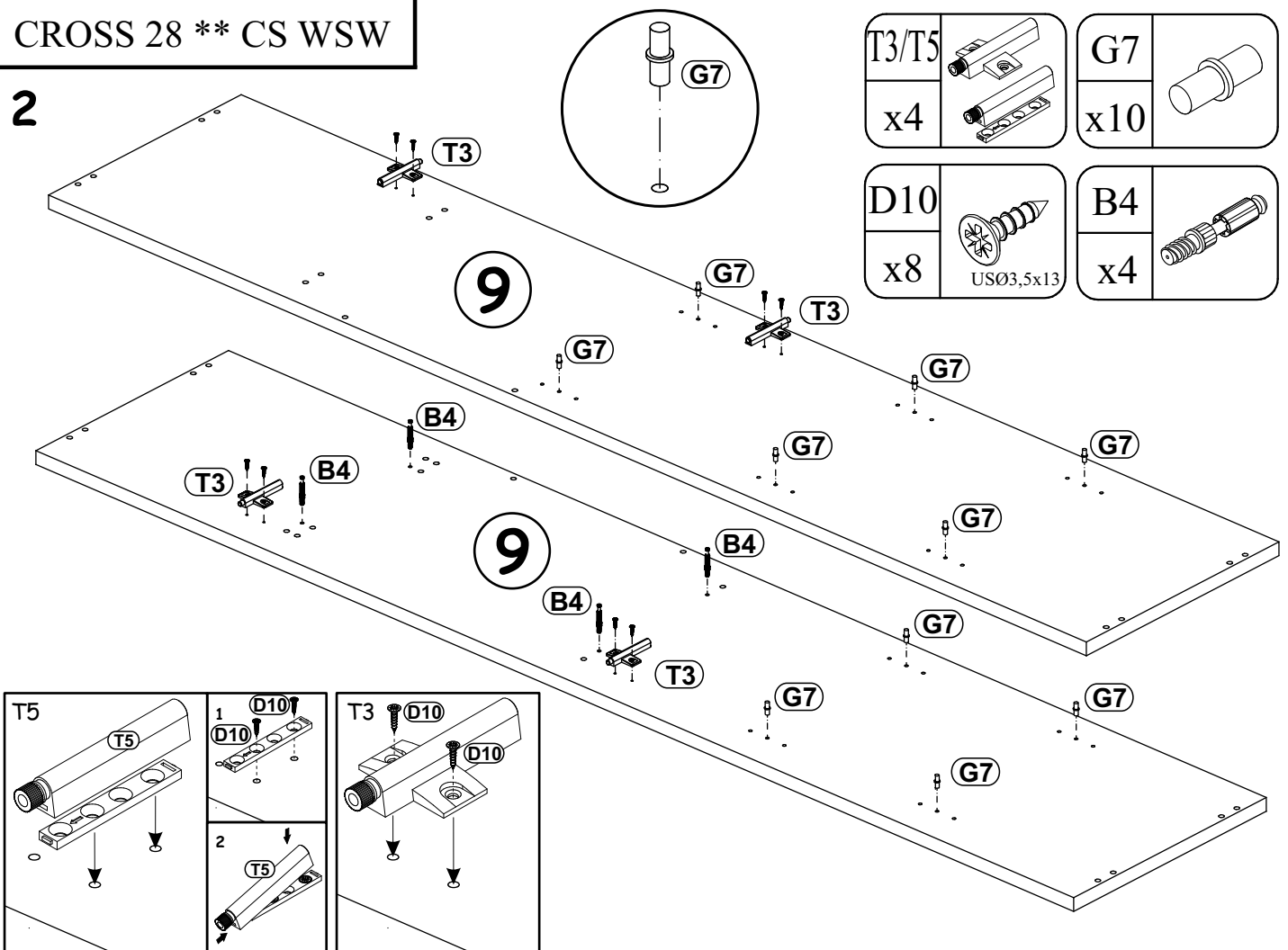

3

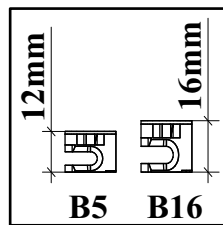
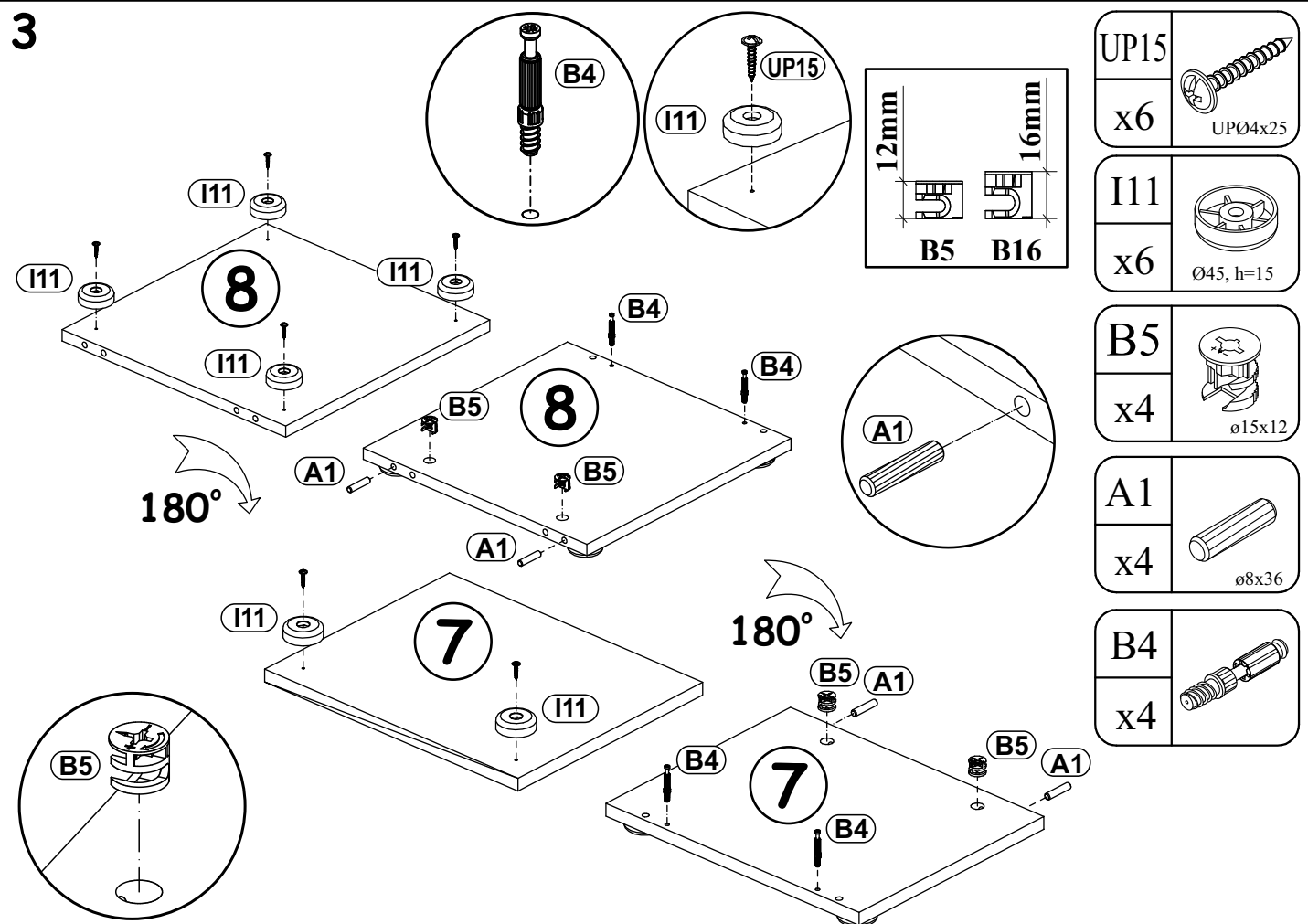

4

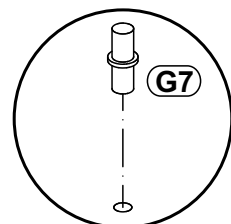
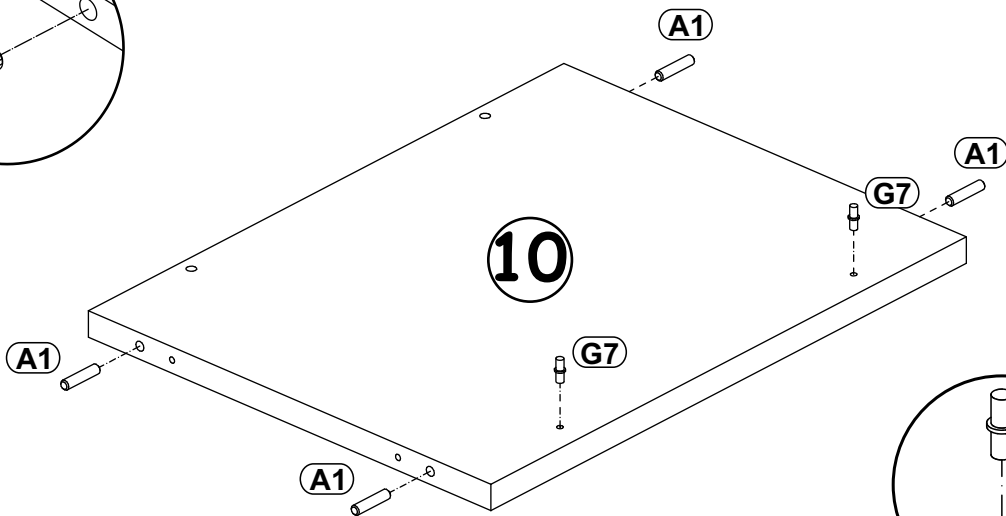
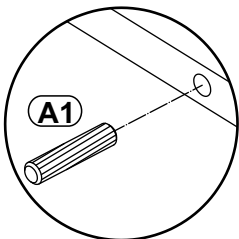
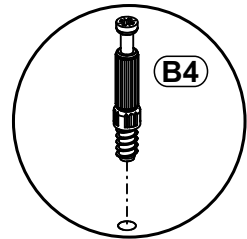
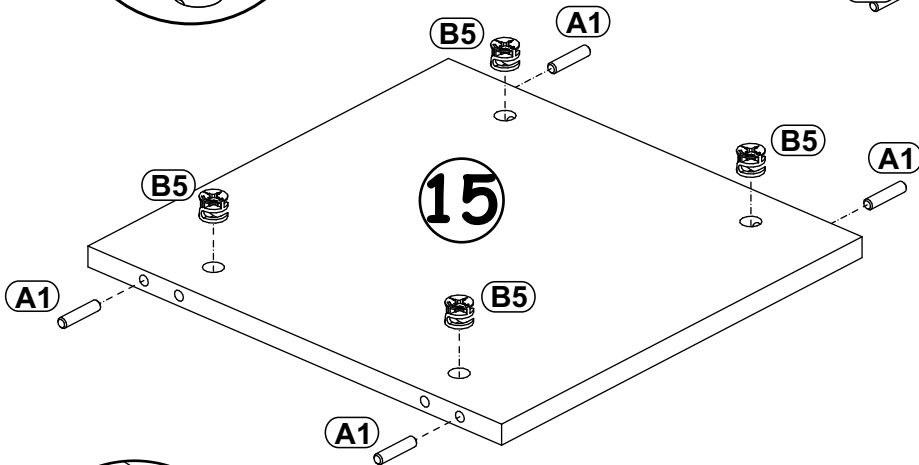
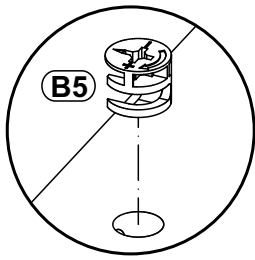
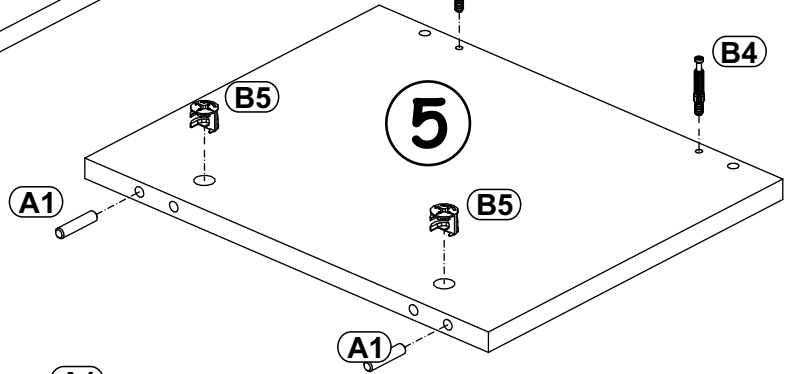
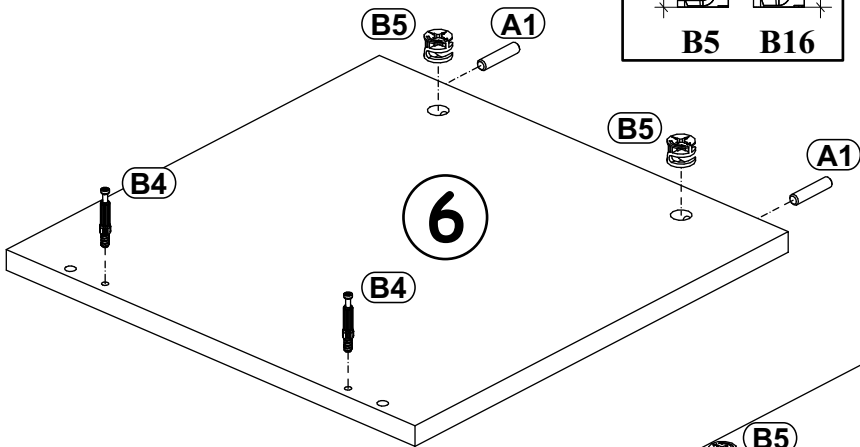
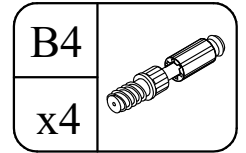
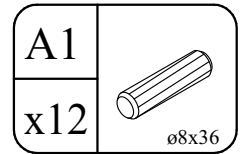
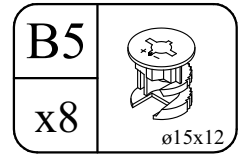
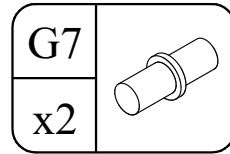
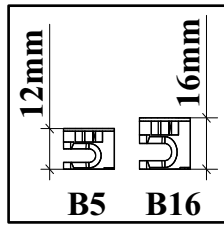

5

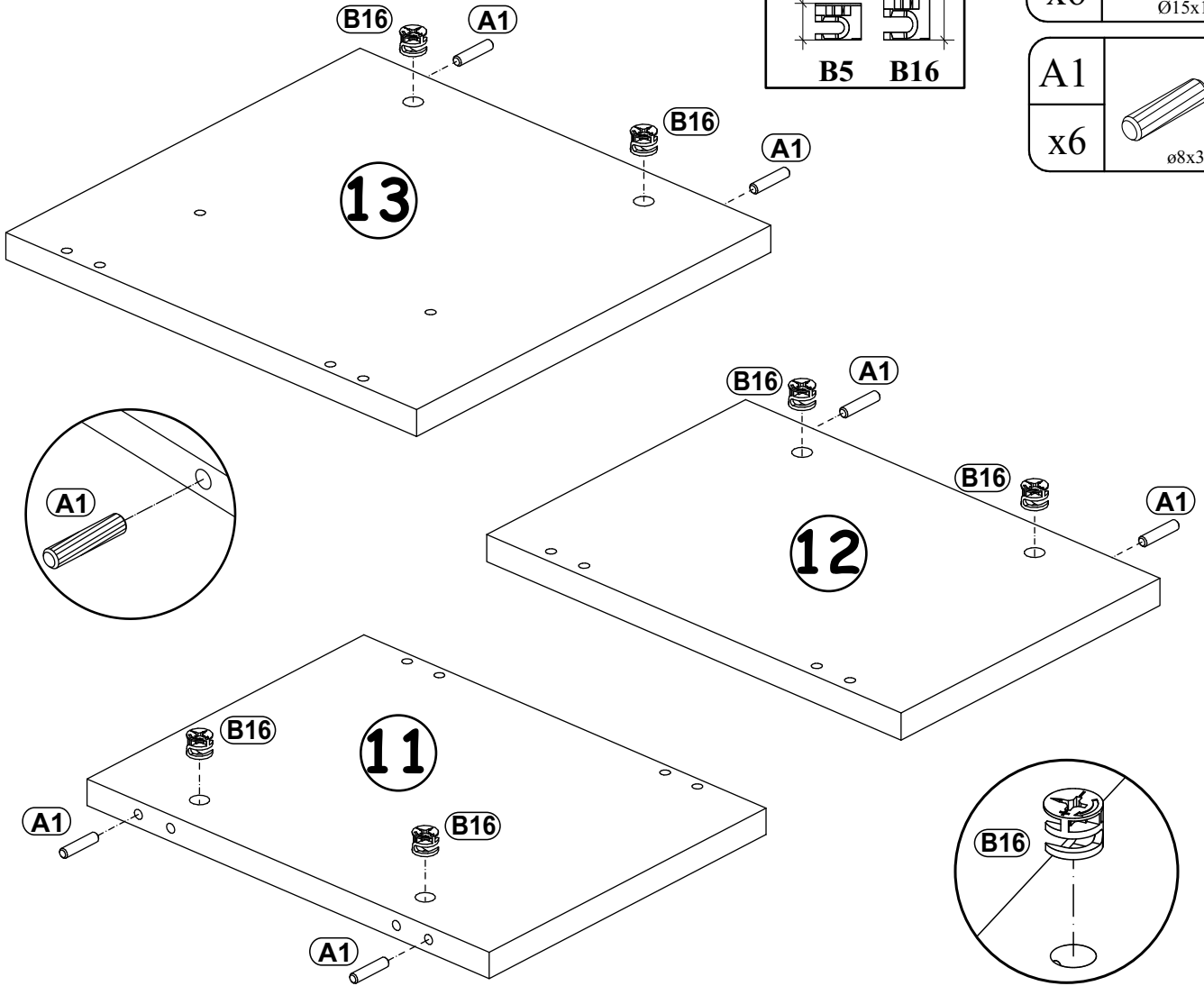

6

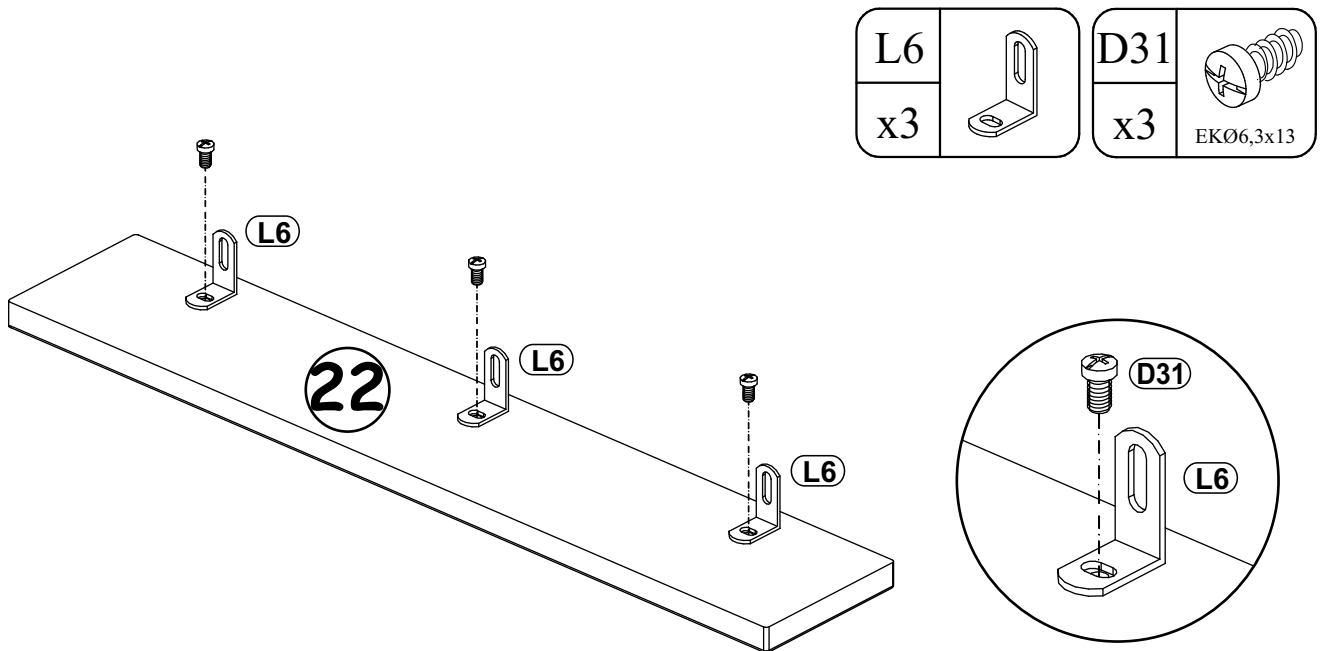

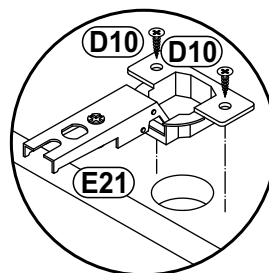
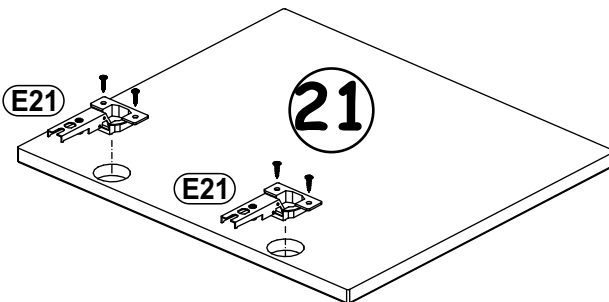
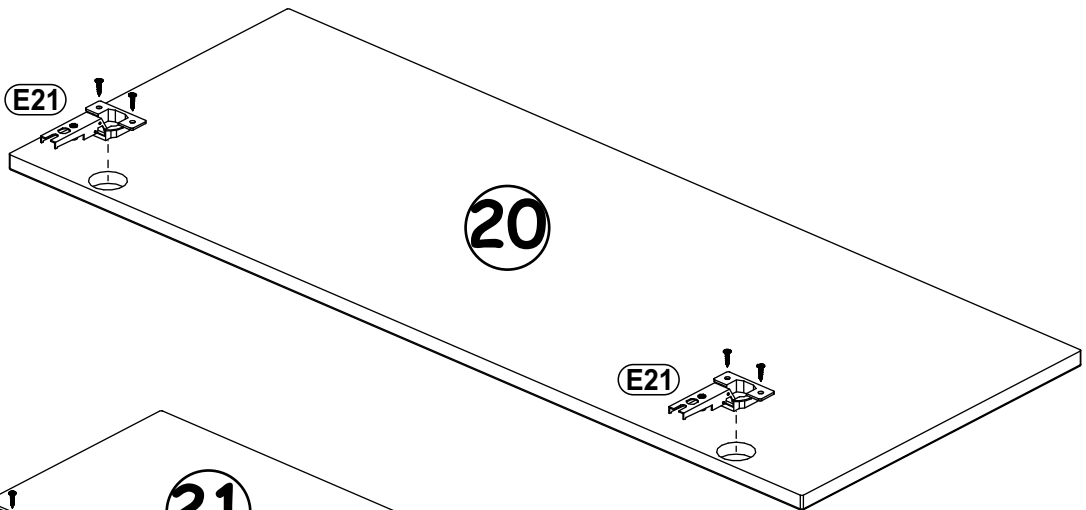
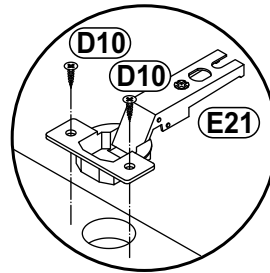
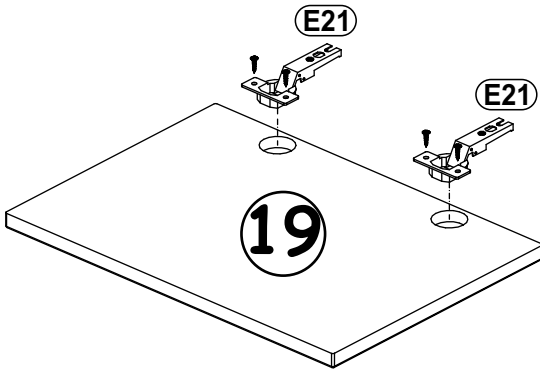
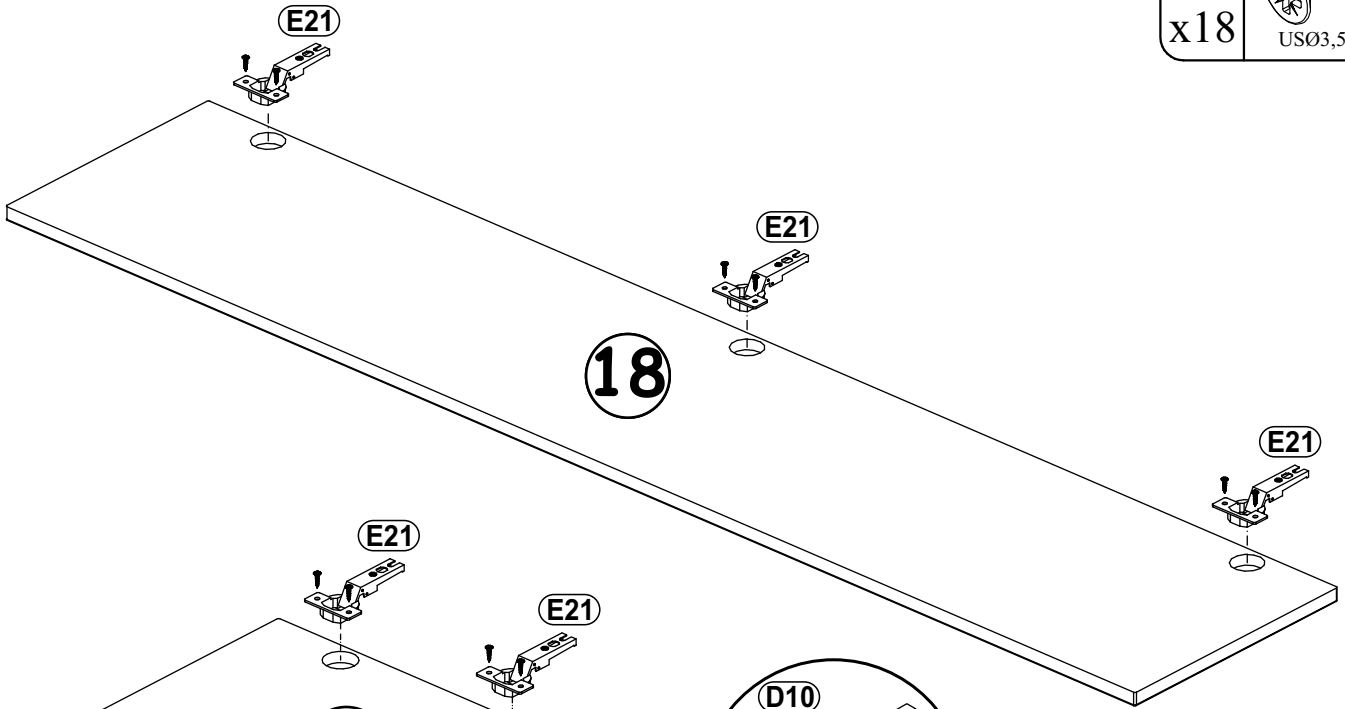
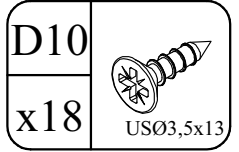
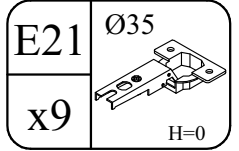
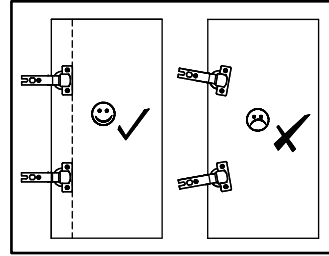
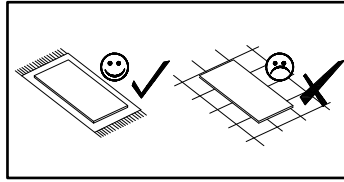

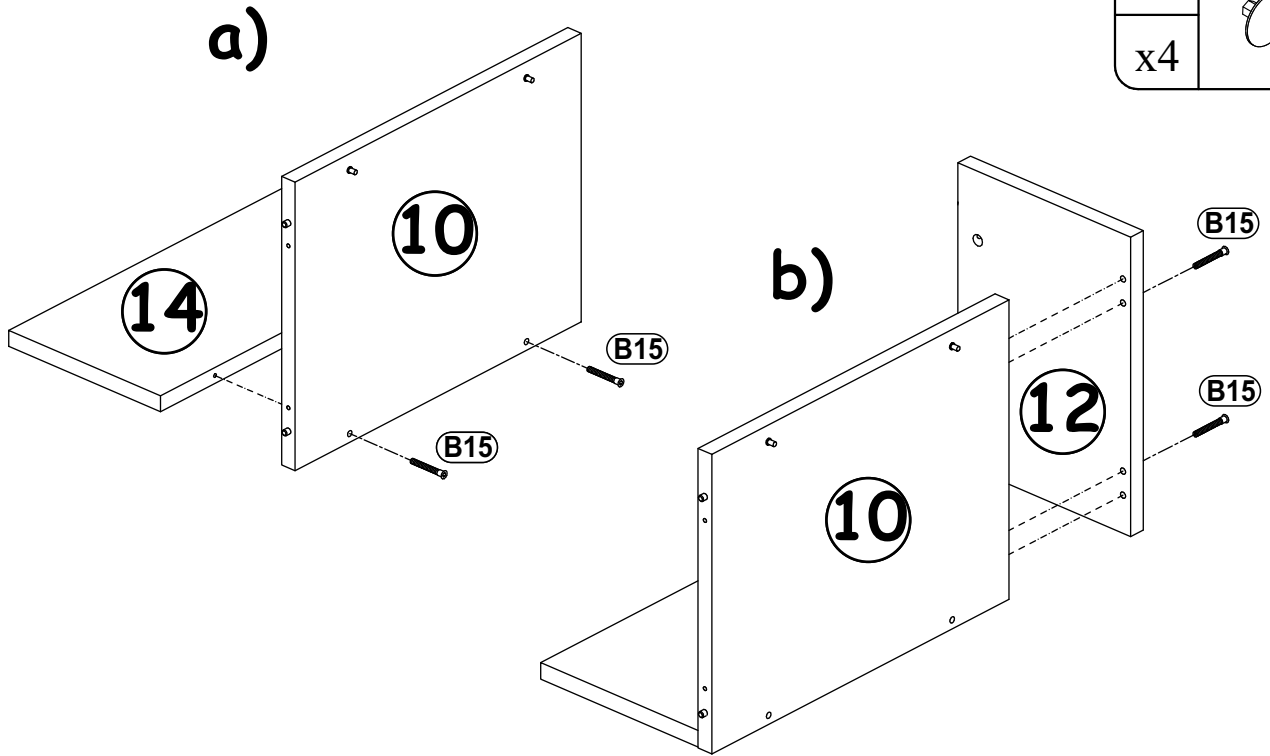
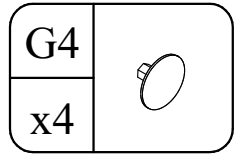
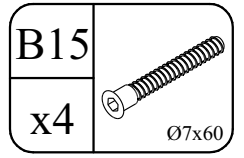
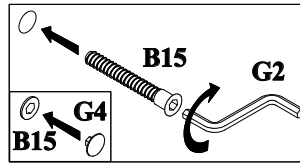

8

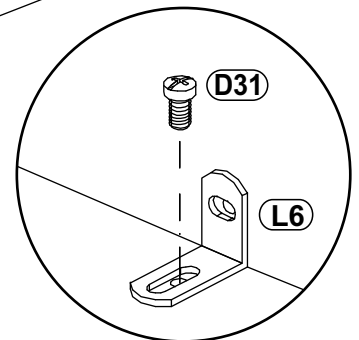
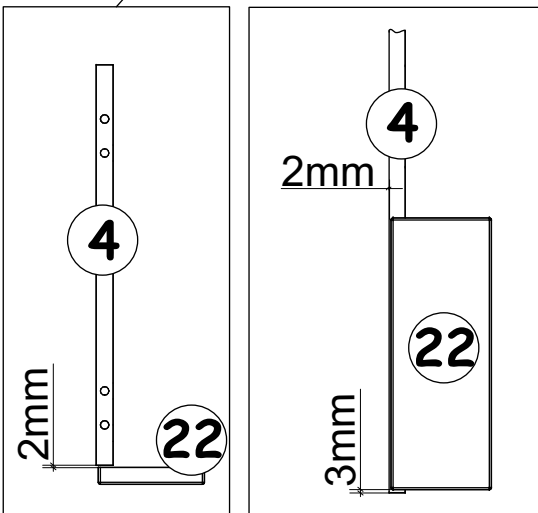
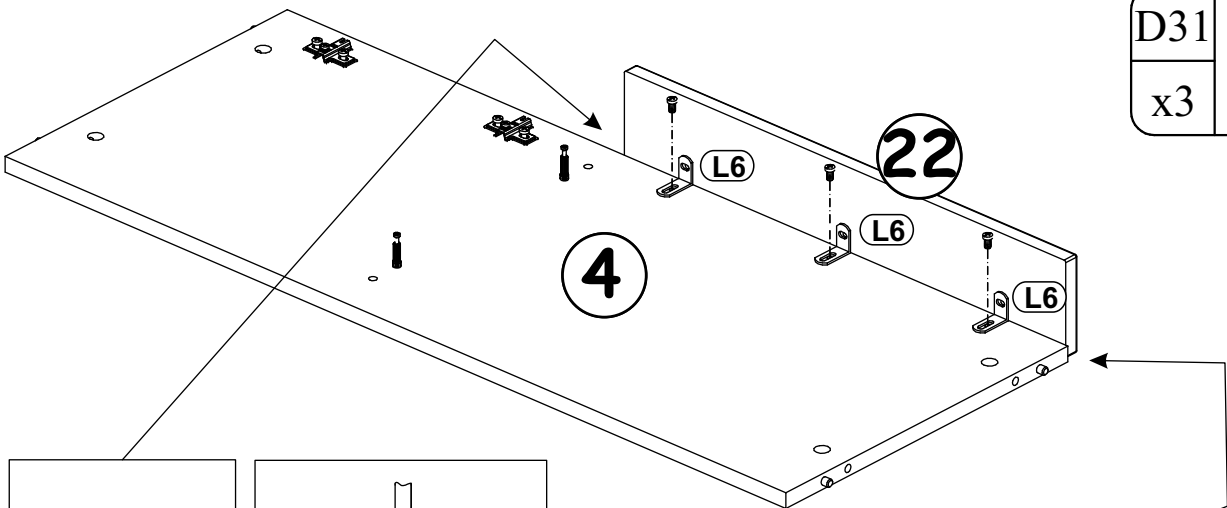
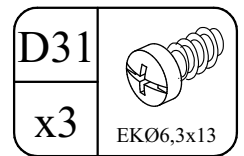

9



10

G5	
x8	

B6	
x2	Ø7x76

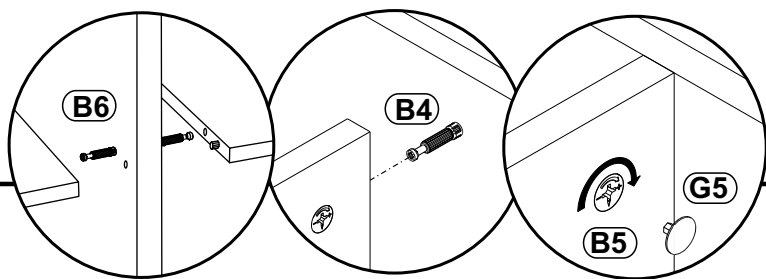
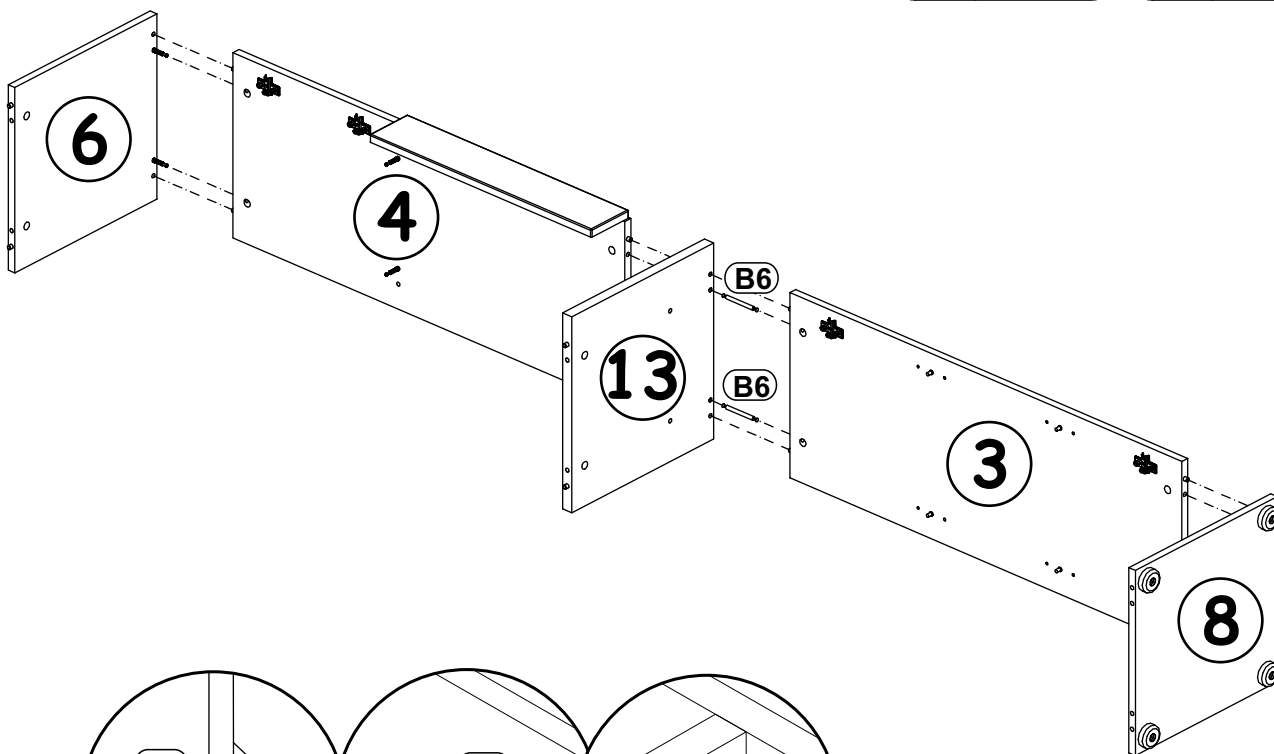

11

G5	
x8	

B6	
x2	Ø7x76

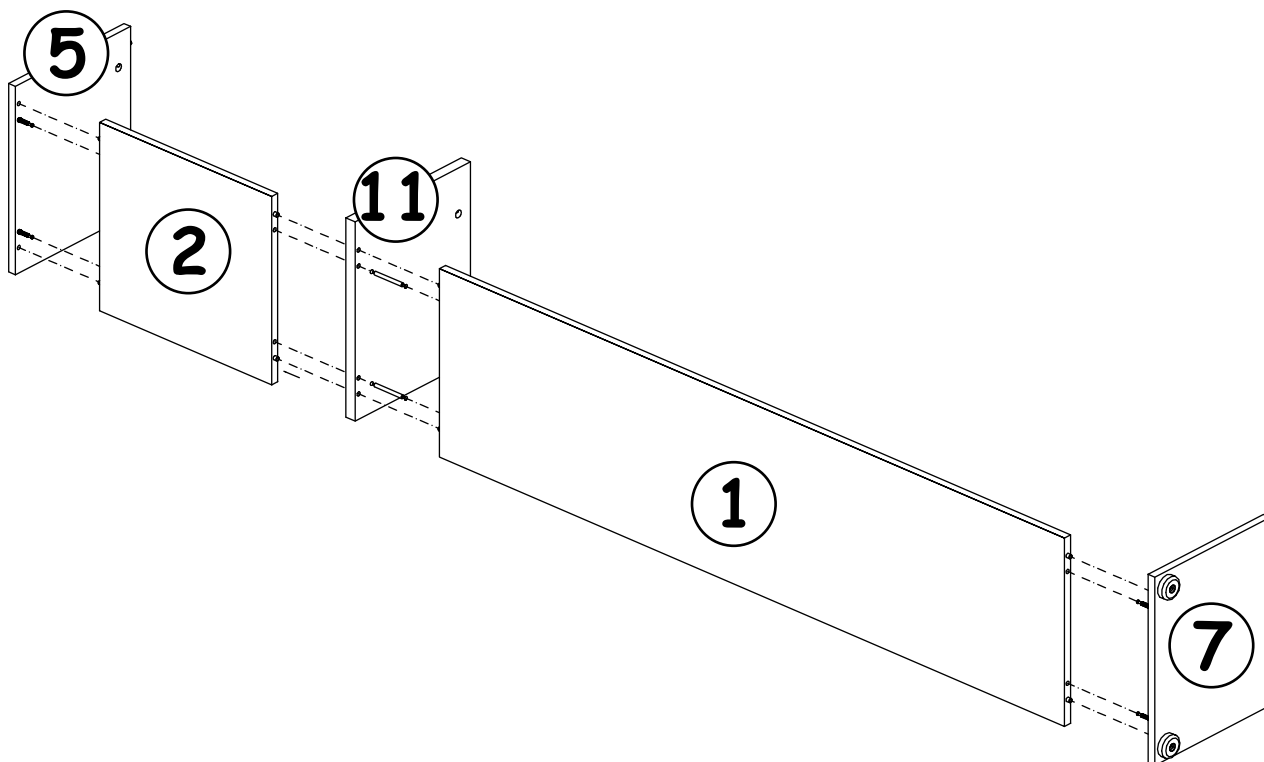

12

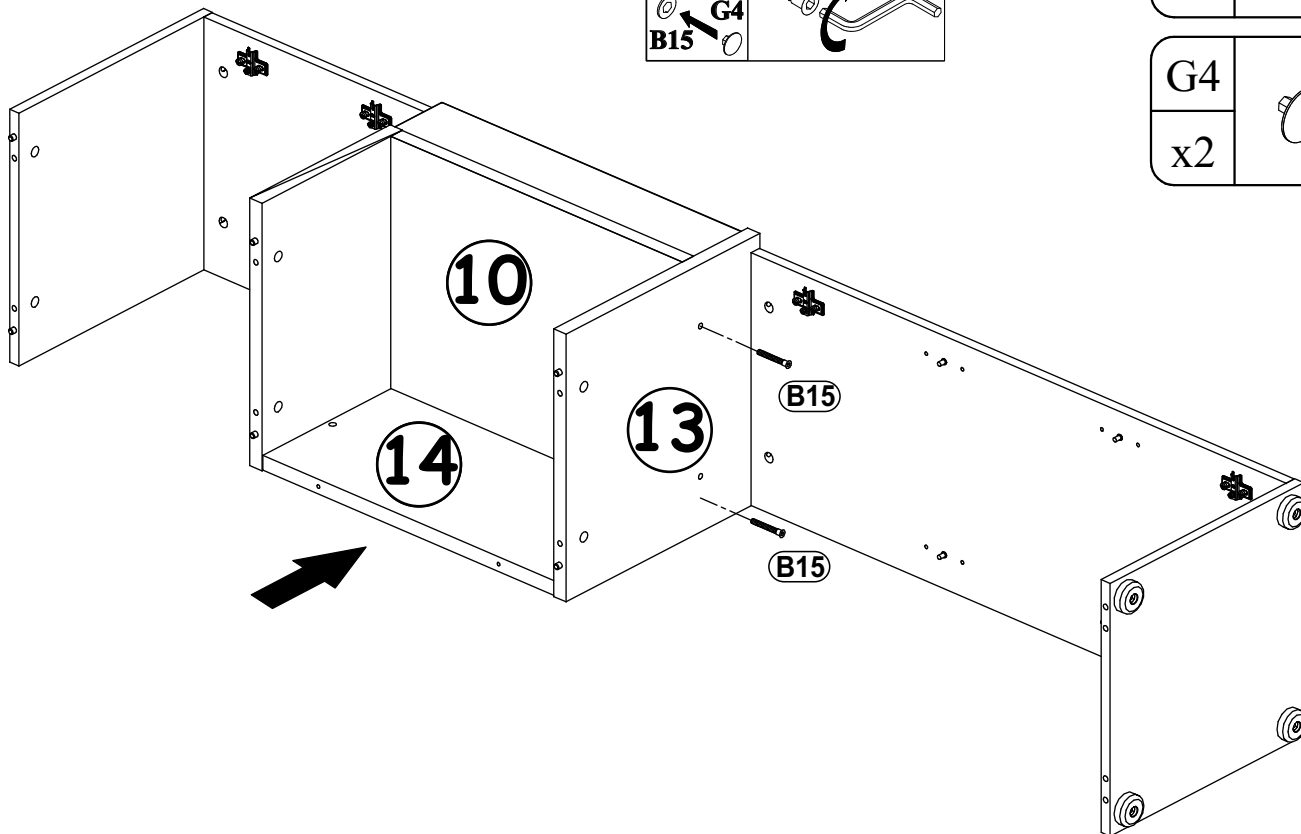
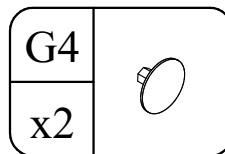
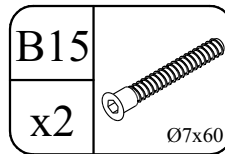
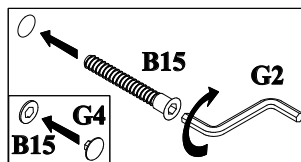

13

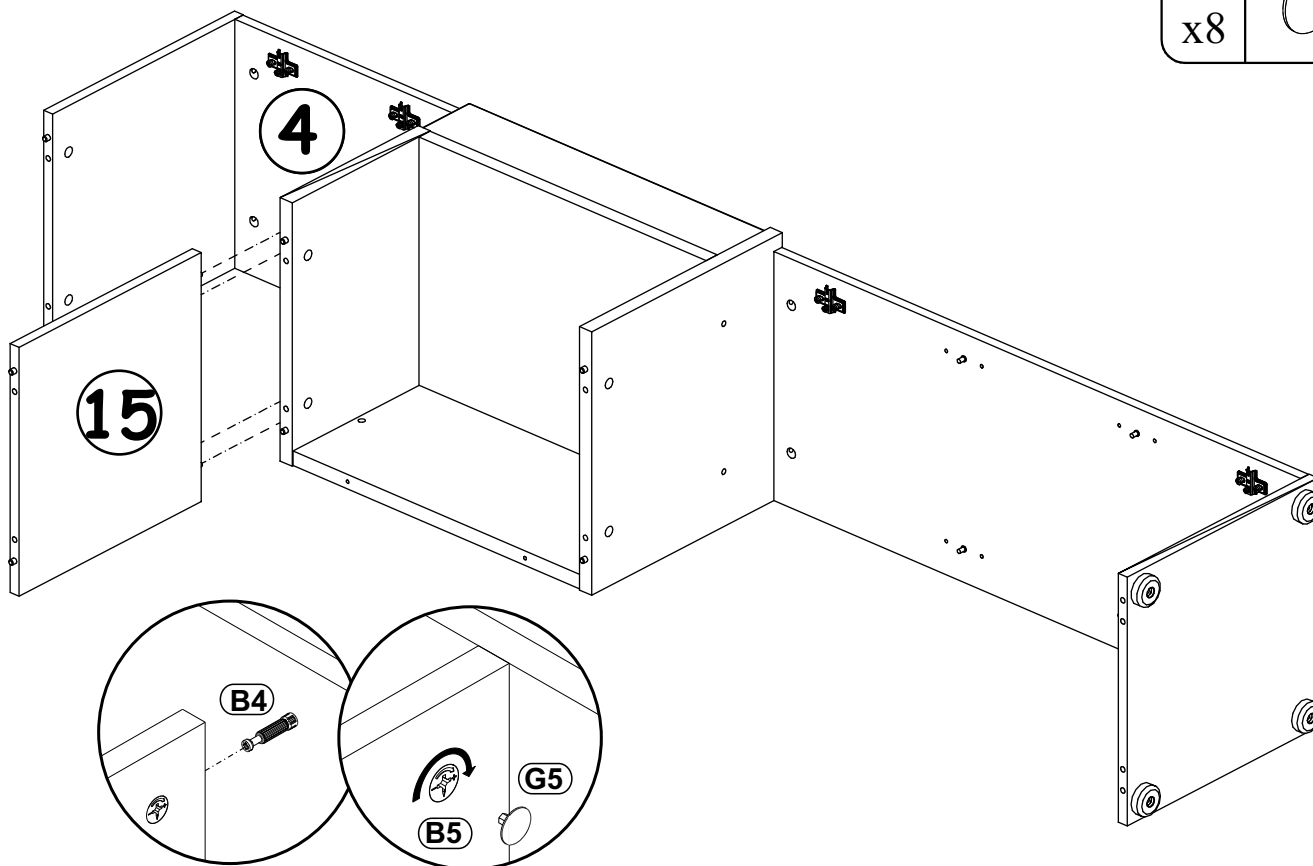
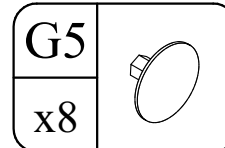

14

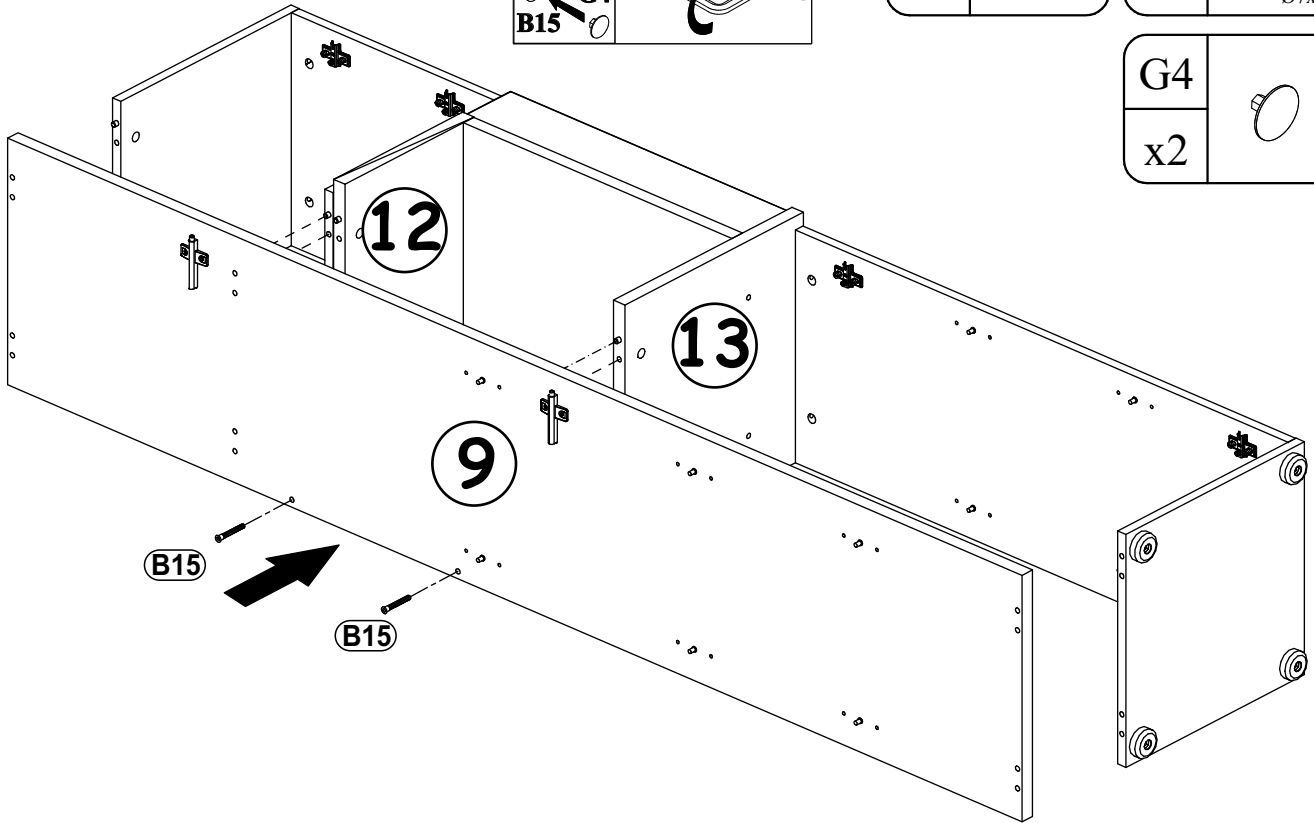
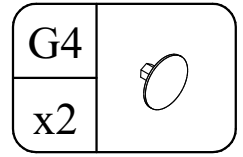
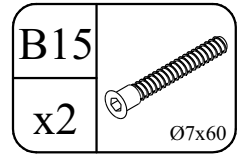
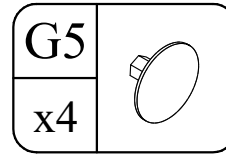
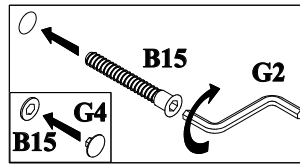

15

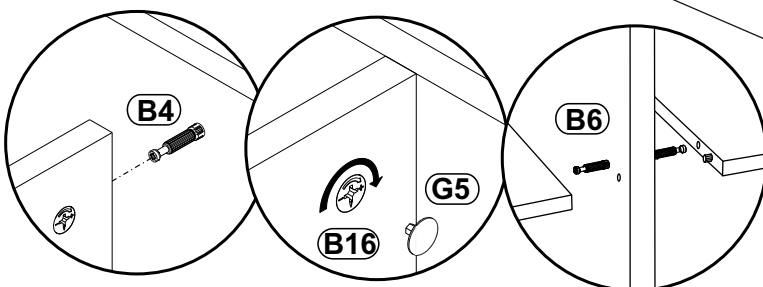
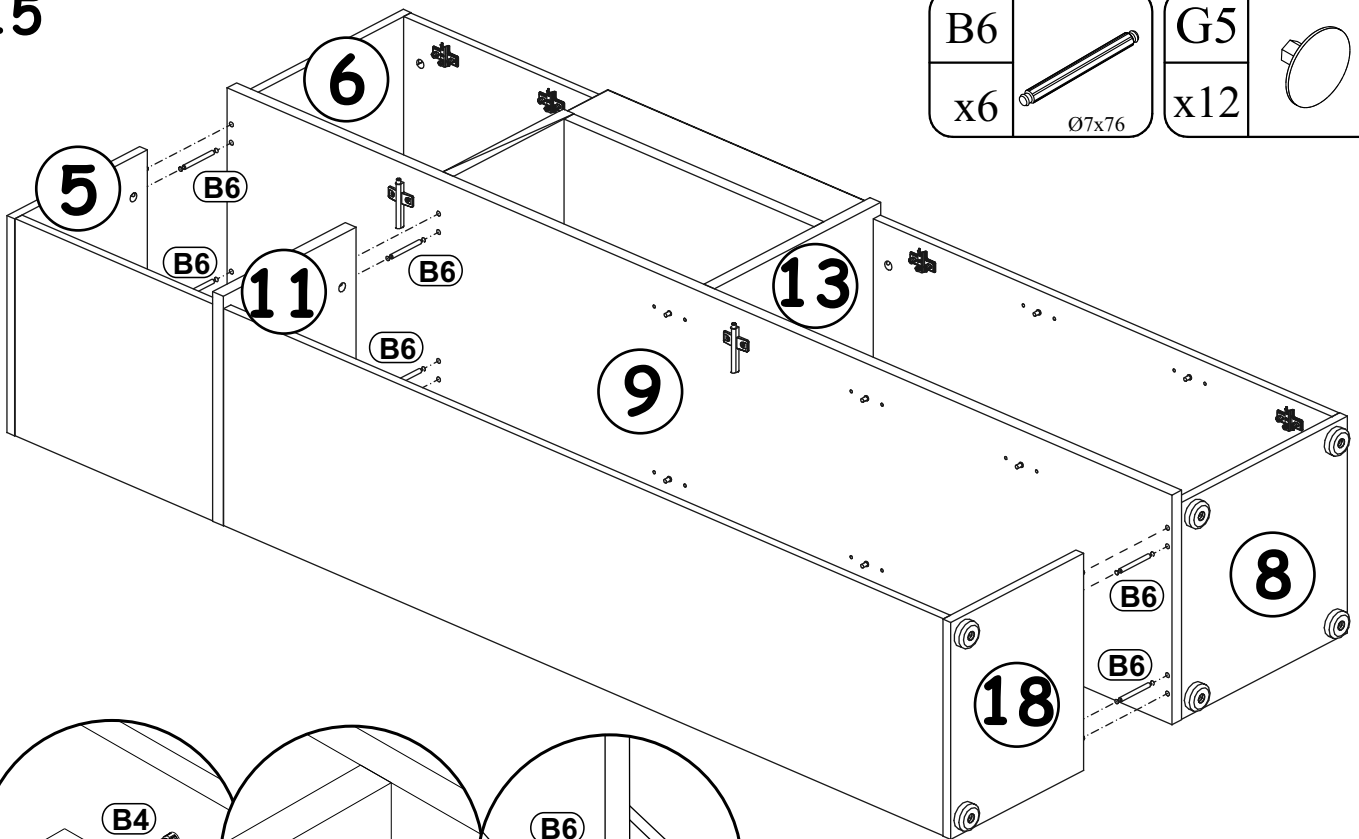
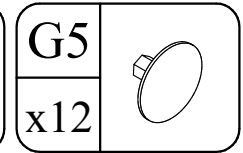
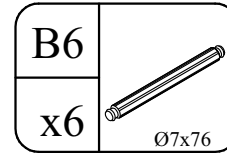

16

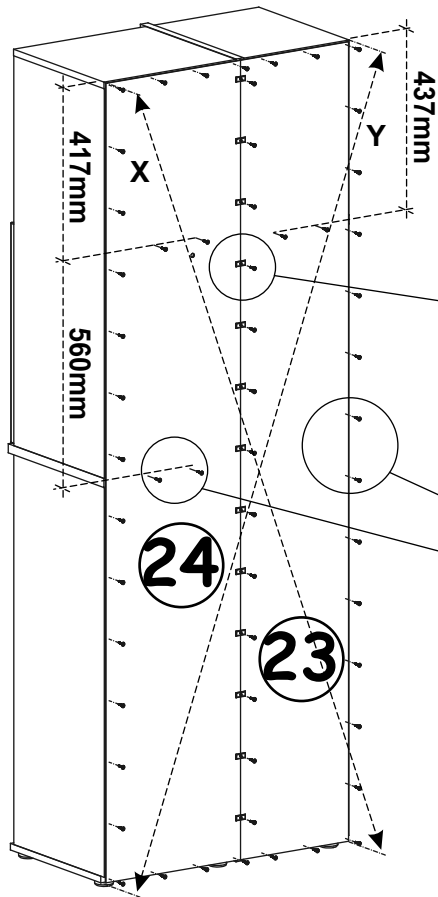

UP13		G16	
x54	UP03x16	x13	

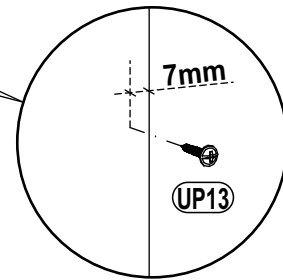
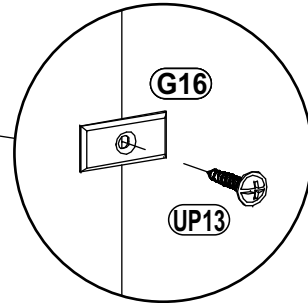
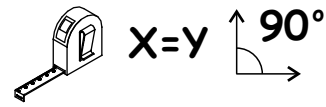

17

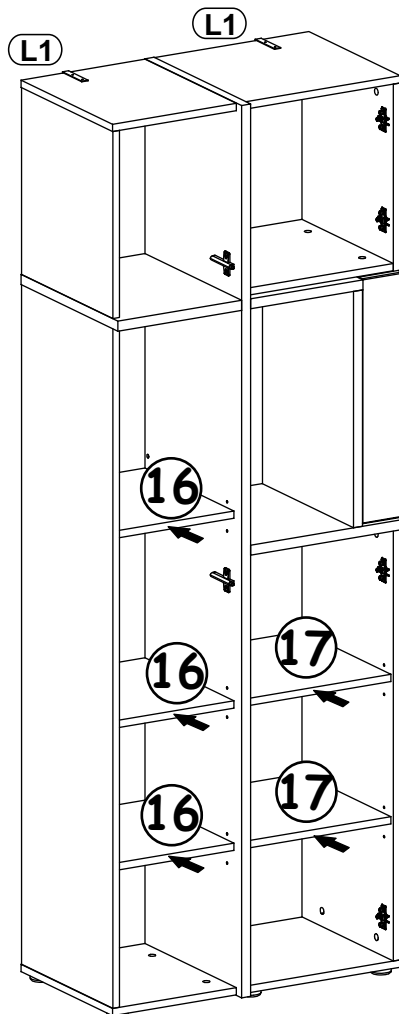
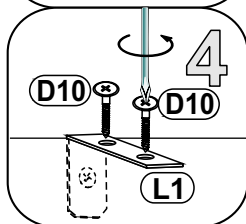
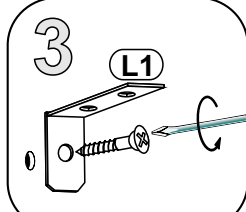
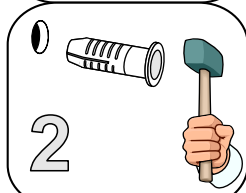
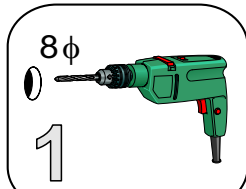

L1		KR1	
x2		x2	

18

