



ASMA KLOZET MONTAJ TALİMATI

INSTALLATION MANUAL OF WALL HANG CLOSET
MANUEL D'INSTALLATION DU CABINET ACCROCHANT
دليل الإستخدام و إرشادات التركيب للمرحاض المعلق ليلا

LILA • DURU • MONA • NOURA

AÇIK MONTAJ DELİKLERİNDEN
KLOZET MONTAJI

*TOILET ASSEMBLY THROUGH
OPEN MOUNTING HOLES*

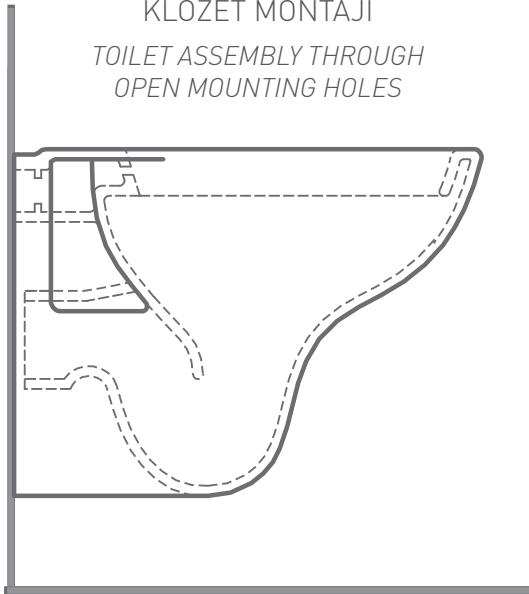

Wall hung wc installation

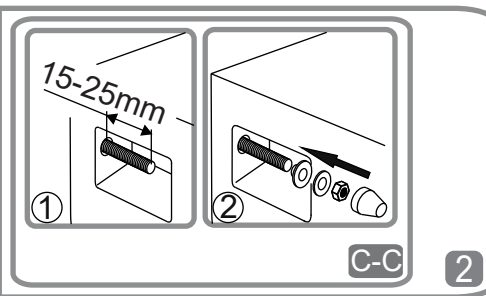
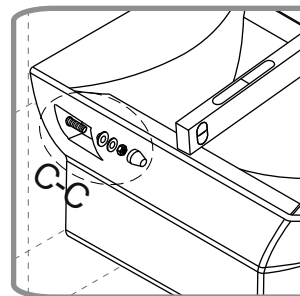
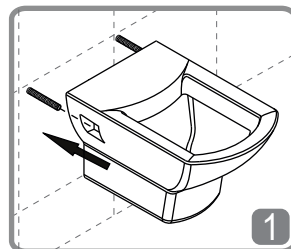
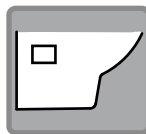
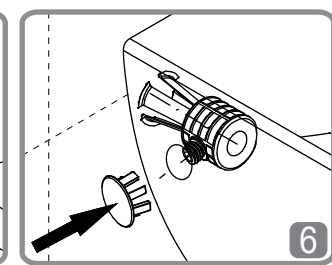
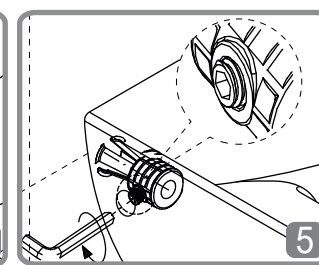
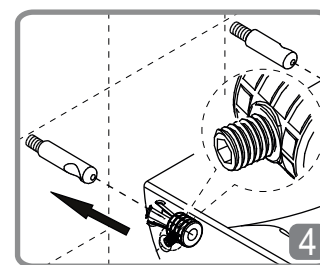
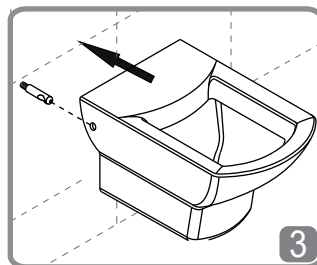
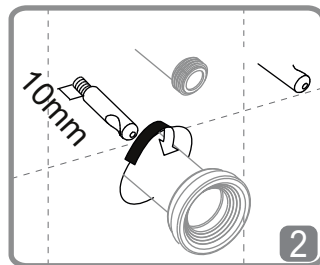
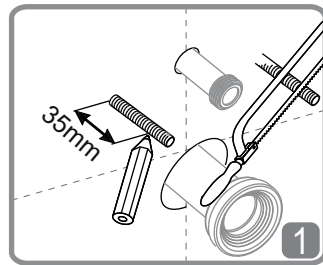
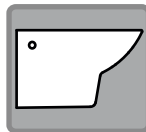
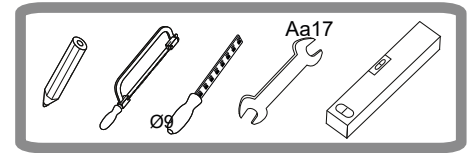
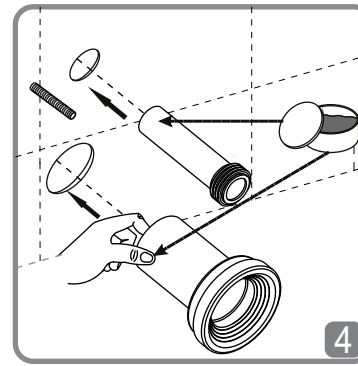
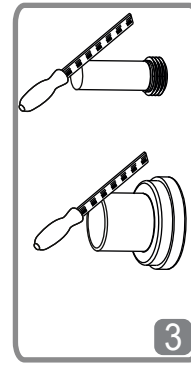
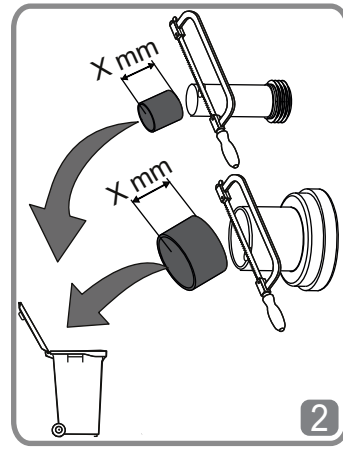
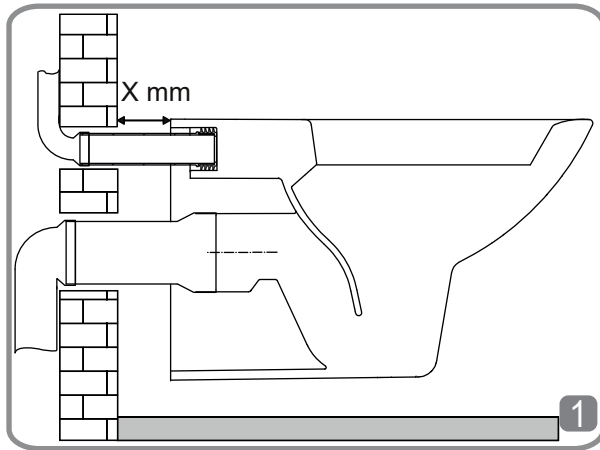

1. Montaj Öncesi Hazırlık Preparation for Installation

Préparation pré-installation الخطوات المتبعة قبل التركيب

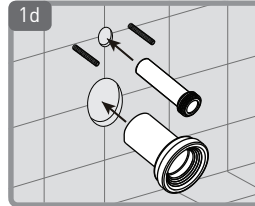
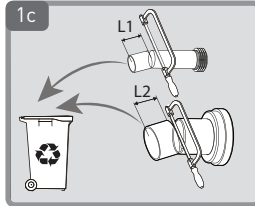
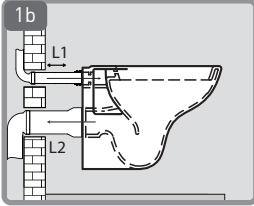
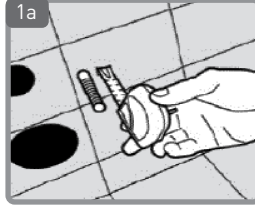
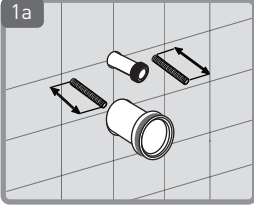

- 1a.** Klozet montaj saplamaları (okla gösterilen) klozet için uygun boylarda ölçülerek kesilir. Extra closet mounting parts (shown with arrow) should be cut regarding needed sizes. Toilettes goujons (indiqués par une flèche) de montage est coupé à des longueurs appropriées mesurées dans les placards.

ضبط و تركيب مسمار التثبيت بحيث يكون متناسب بالطول مع المرحاض

- 1b.** Asma klozet; gömme rezervuarın, temiz su borusu ve pis su gider borusu fazla kısmı kesilmek üzere gömme rezervuara şekilde görüldüğü gibi konumlandırılır ve L1/L2 mesafeleri ölçülür.

Drain pipe and clean water pipes should be adjusted to the wall like as shown on Picture 2c. Le cabinet accrochant; réservoir de rinçage, les conduites d'eau potable et des égouts coûte l'excédent est positionné comme indiqué sur la figure cachée citerne à couper et L1 / L2 la distance sont mesurés.

L1/L2 تركيب انابيب المياه النظيفة و العادمة و قياس المسافة الزائدة بين الحائط والمرحاض

- 1c.** Gömme rezervuarın, temiz su borusu ve pis su gider borusu fazla kısmı L1/L2 ölçülerinde kesilir.

Unneeded parts of drain pipe and clean water pipe should be cut according to L1 and L2 dimensions.

À réservoir intégré, les conduites d'eau potable et d'égout drainage des tuyaux autant partie de la coupe L1 / L2 en taille.

قص الأجزاء الزائدة من انابيب المياه L1/L2 كما هو موضح بالشكل

- 1d.** Gömme rezervuara, temiz su borusu ve pis su gider borusu tekrar monte edilir.

Clean water pipe and drain pipe should be fixed to the concealed cistern.

Intégré dans le réservoir, les conduites d'eau potable et les tuyaux d'évacuation des eaux usées installés à nouveau.

تثبيت الانابيب مكانها مع الخزان الداخلي، كما هو موضح بالشكل

2. Asma Klozet Montajı Installation Wall Hang Closet

D'installation du cabinet accrochant تركيب المرحاض



2a. Klozetteki taharet bağlantı dirseğine flexi bağlantısı yapılır.

How the bidet system should be connected.

Toilettes connexion coude dans la connexion de flexi bidet est faite.

تنبيت خرطوم الطهارة مع كوع التنبيت على المرحاض

*** Bağlantı öncesi dirsek kontrolü klozet montajını yapan servis tarafından

kesinlikle kontrol edilmelidir. Gevşek bırakılması veya çok sıkılması (iç contayı yırtacak kadar) halinde su kaçağına sebebiyet verebilir.

Before the installation of wall hang closet to wall, back connection of the bidet system pipe must be controlled for leakage by installer.

L'accès doit être strictement contrôlé par le coude avant d'installer la portion de contrôle de placard.

Lâche ou trop fatigué pour quitter (jusqu'à déchirer le joint intérieur) peut provoquer des fuites dans l'eau.

يجب فحص موضع خرطوم الطهارة من قبل عامل الصيانة الذي يقوم بالتركيب بحيث

لا يكون مرخي أو مشدود كثيرا حتى لا يمزق جلدة الحماية مما يؤدي الى التسرب .

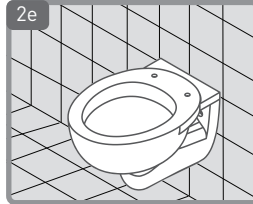
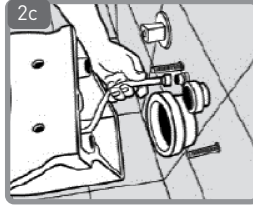
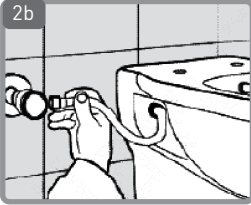

2b. Taharet çubuğu flex bağlantısı açık şekilde yapılacaksa, flexi hortumun klozetin yan açıklıktan geçirilerek ara musluk ile bağlantısı yapılır.

If the bidet system should be mounted outside the flexi holes should be connected through the side hole and connected to the water source.

Si barre de lustration connexion flex a été de manière ouverte à fait, recherche par le biais de la connexion de tuyau flexible est réalisée avec des ouvertures latérales du robinet de toilette.

يتم تركيب خرطوم الطهارة وفقا لمصدر المياه ، إذا كان غير مخفي يجب تمرير الخرطوم من الفتحة الجانبية للمرحاض و ربطه بمصدر المياه الخارجي كما هو موضح بالشكل

2c. Ankastré valfli gizli montaj ile yapılacak bağlantı ise flexi temiz su girişine klozetin arkasından bağlanarak montaj tamamlanır.

In case assembling should be made with built-in valve, the flex hose should be connected to bidet system from the back side of the closet.

Construit en connectant l'ensemble de soupape qui se tiendra par placard secret dans le dos de la exi propre ensemble d'entrée d'eau est terminée.

إذا كان المصدر مخفي يتم ربط الخرطوم مع مصدر المياه المخفي كما هو موضح بالشكل

2d. Daha sonra sağ ve sol klozet montaj vidaları anahtar yardımıyla sıkılarak montaj tamamlanır.

Mount the closet by fixing the screws at sides.

Ensuite, avec l'aide des vis de montage de toilettes clés gauche et droite ensemble serré est terminé.

بعد ذلك يتم تثبيت المرحاض بالحائط و شد المسامير الجانبية جيداً

2e. Montajı tamamlanmış ürünün kullanım öncesi montaj kaynaklı sorun olmadığı kontrol edilmelidir.

All connection points must be double checked after installation before using the closet.

L'utilisation de produits pré-assemblés doit être vérifié pour des problèmes liés à l'installation.

قبل الإستخدام يتم التأكد من أن التثبيت تم بشكل صحيح و أنه لا يوجد أي

خلل في أي جزء من أجزاء المرحاض