

A	B	C	D	
1	S322-003	794	240	4/4
2	S322-004	1616	396	3/4
3	S322-103	1968	540	1/4
4	S322-104	1968	540	1/4
5	S322-202	884	551	2/4
6	S322-301	800	537	2/4
7	S322-402	800	80	2/4
8	S322-403	800	80	2/4
9	S322-904	773	505	2/4
10	S322-906	1925	825	1/4
11	ZS3-5620	751	200	2/4
12	ZS4-541	500	200	2/4
13	ZS4-542	500	200	2/4
14	dr-792	792	22	2/4

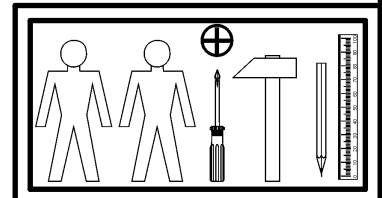

8x k16 a43	8x b19	3x M4 c415	4x Ø6,3x15 mm d4	6x Ø6x13 mm e3	6x Ø5x9 mm e19	12x Ø8x30 mm f1	2x Ø6x30 mm f9	4x Ø6,5x40 mm f25
3x M4x20 mm j1	4x k1	65x l1	2x h=22mm n1	1x n26	2x Ø3,5x13 mm p1	1x Ø3,5x16 mm p25	1x Ø3,5x10 mm p35	7x Ø3,5x16 mm p38
16x Ø3,5x15 mm p51	16x Ø15x12 mm #16 r1	4x Ø12x10,5 mm #12 r15	20x 20/11 r42	6x Ø16 s2	1x 500 mm t34	1x 500 mm w26\CL	1x 500 mm w26\CR	1x 500 mm w26\DL
1x 500 mm w26\DR								

1

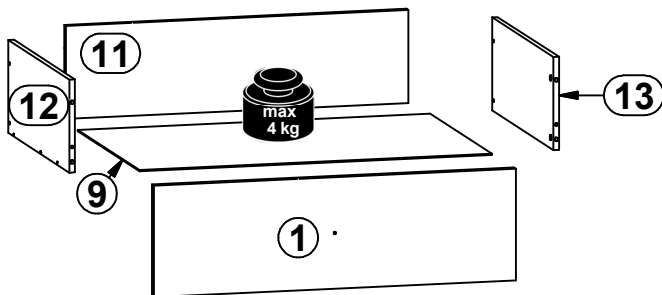
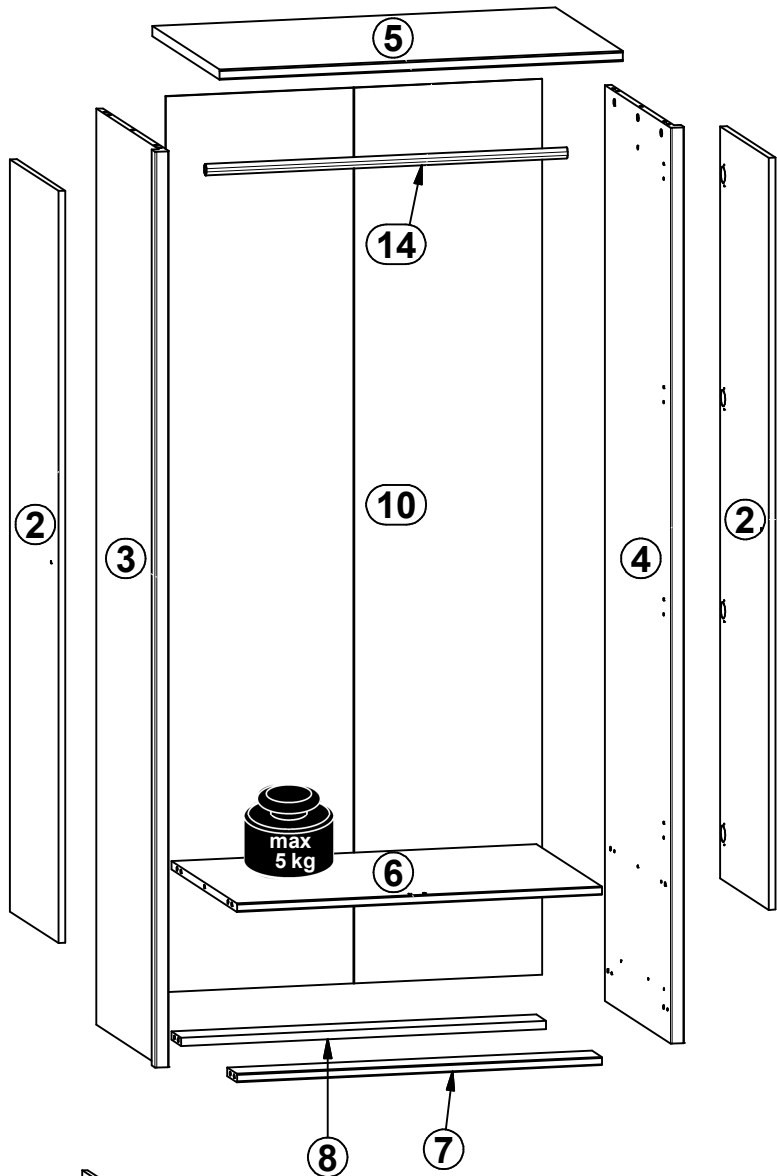
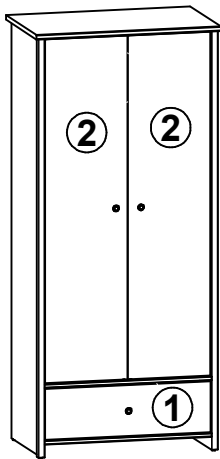
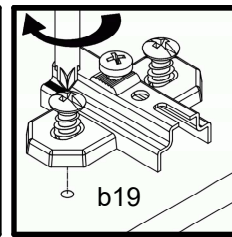
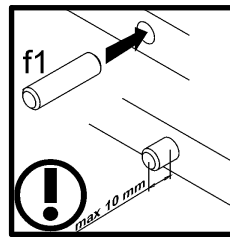
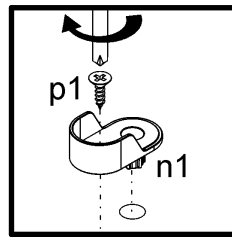
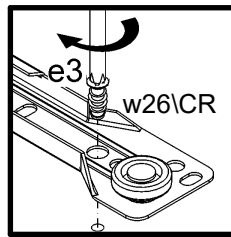
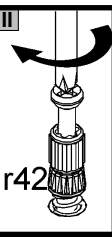
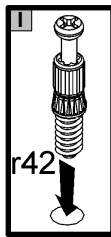
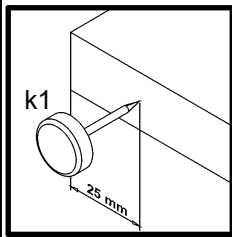
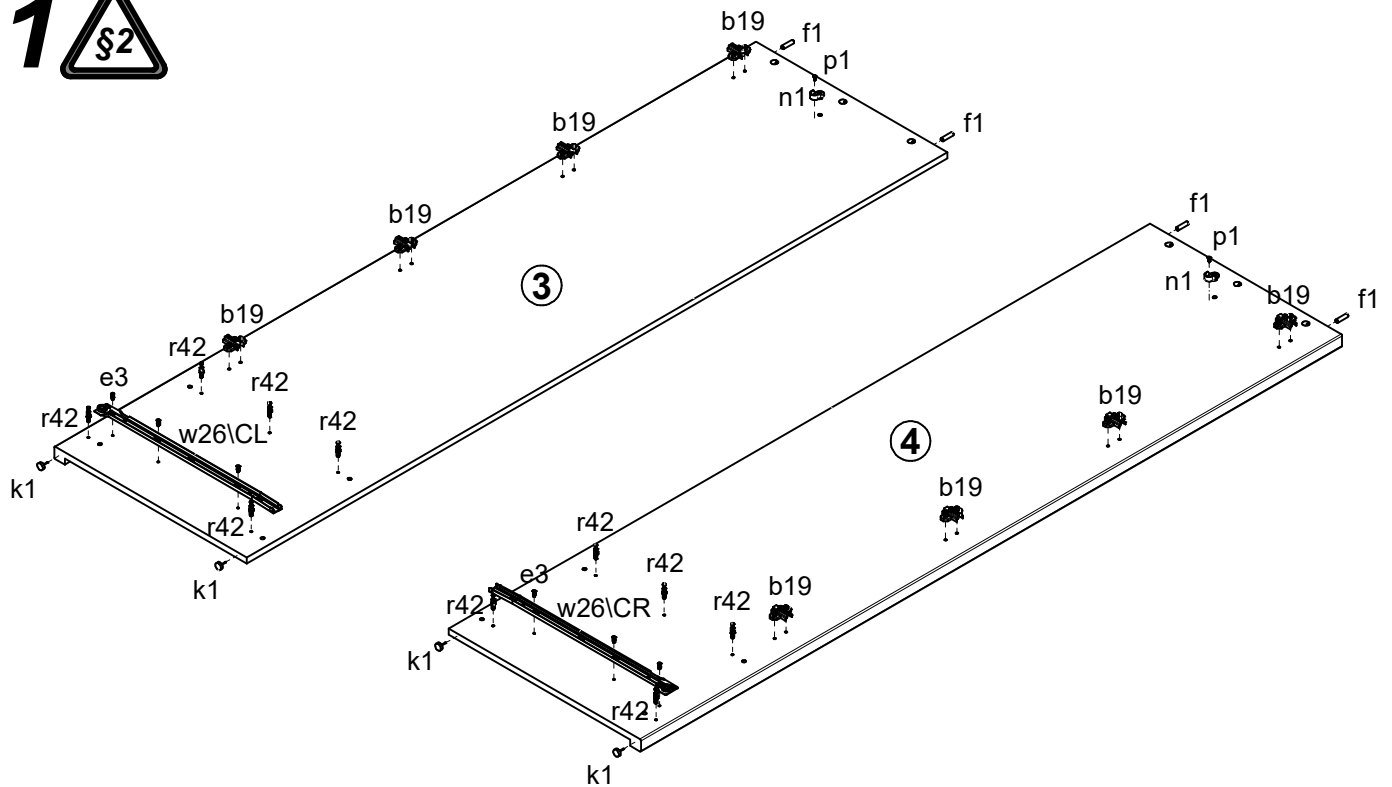

2

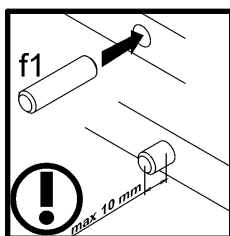
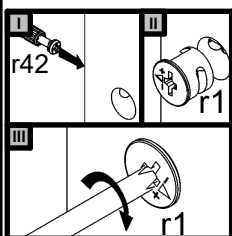
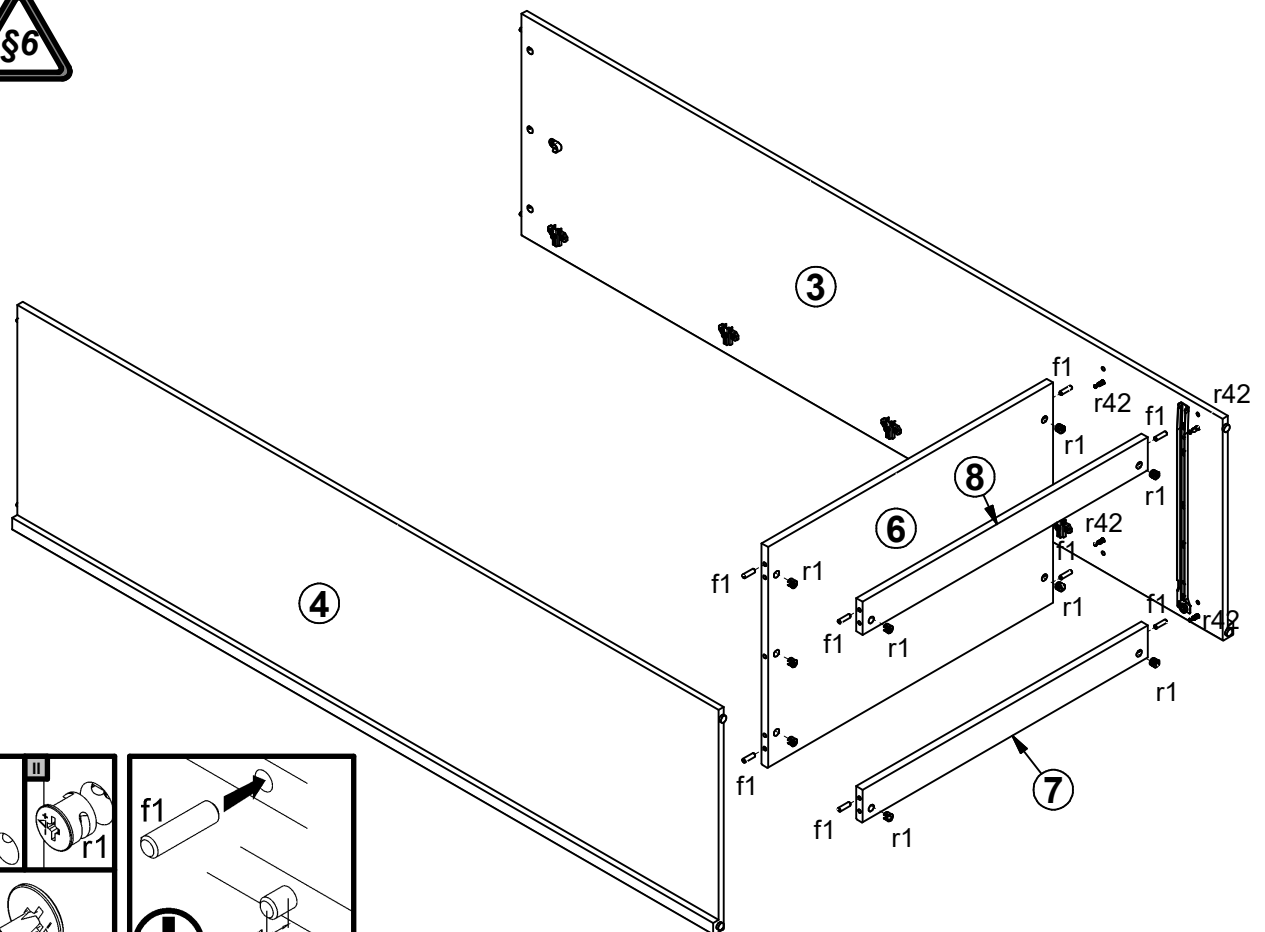

3

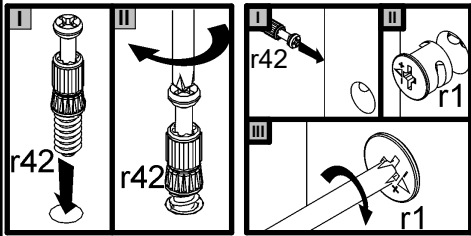
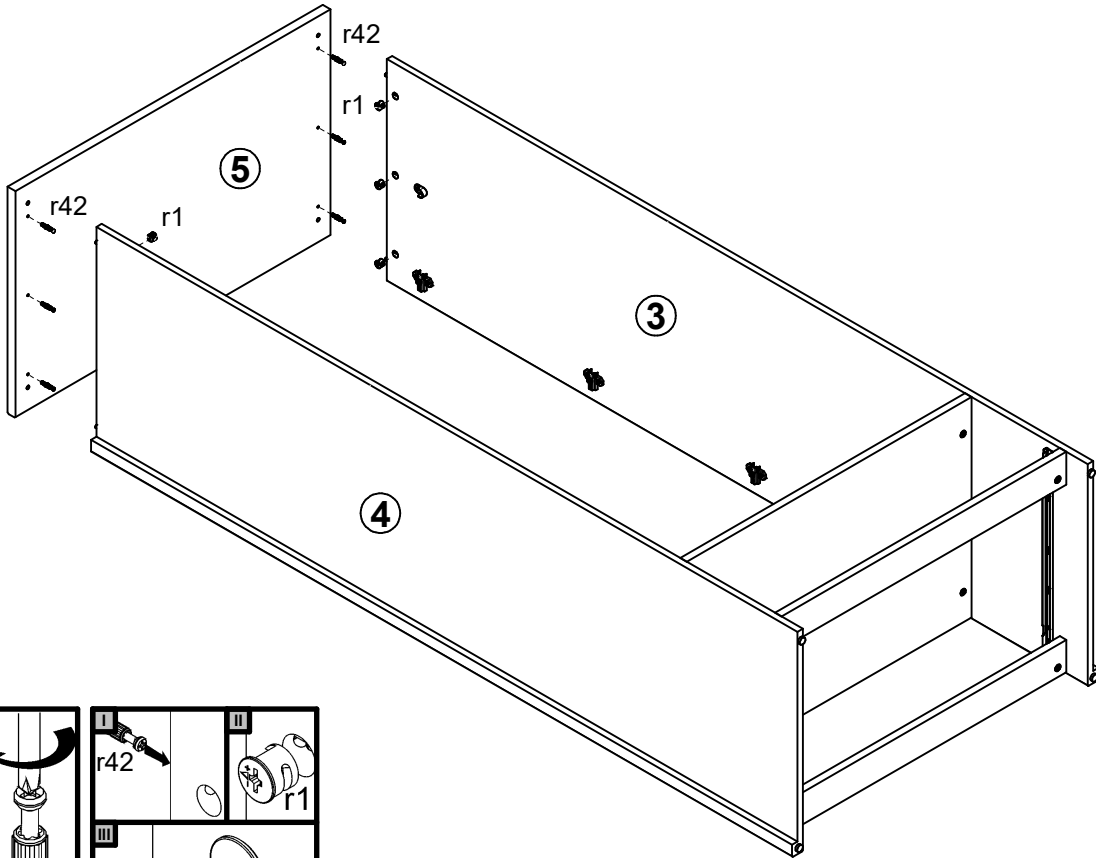

4

