

A	B	C	D	
1	S322-031	865	348	4/4
2	S322-144	434	368	1/4
3	S322-145	434	368	1/4
4	S322-215	954	379	1/4
5	S322-216	954	337	1/4
6	S322-330	870	365	1/4
7	S322-331	869	341	1/4
8	S322-419	1800	900	2/4
9	S322-420	1404	559	3/4
10	dr-292	292	22	1/4

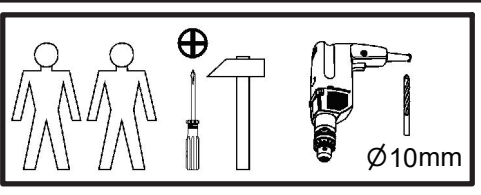

2x k16 a43	2x b19	1x M4 c415	4x Ø5x17 mm d1	7x Ø7x50 mm e1	20x Ø8x30 mm f1	2x Ø10x50 mm f35	3x g49	1x M4x20 mm j1
6x M4x22 mm j60	4x k1	2x L-230 m48	2x h=22mm n1	2x 81x21x15/1,5 n14	2x silikon o21	10x Ø3,5x13 mm p1	2x Ø5x60 mm p17	4x Ø3,5x16 mm p38
4x Ø3,5x15 mm p51	17x Ø15x12 mm #16 r1	17x 2011 r42	10x Ø16 s2	1x z1				

**1** §2 §11

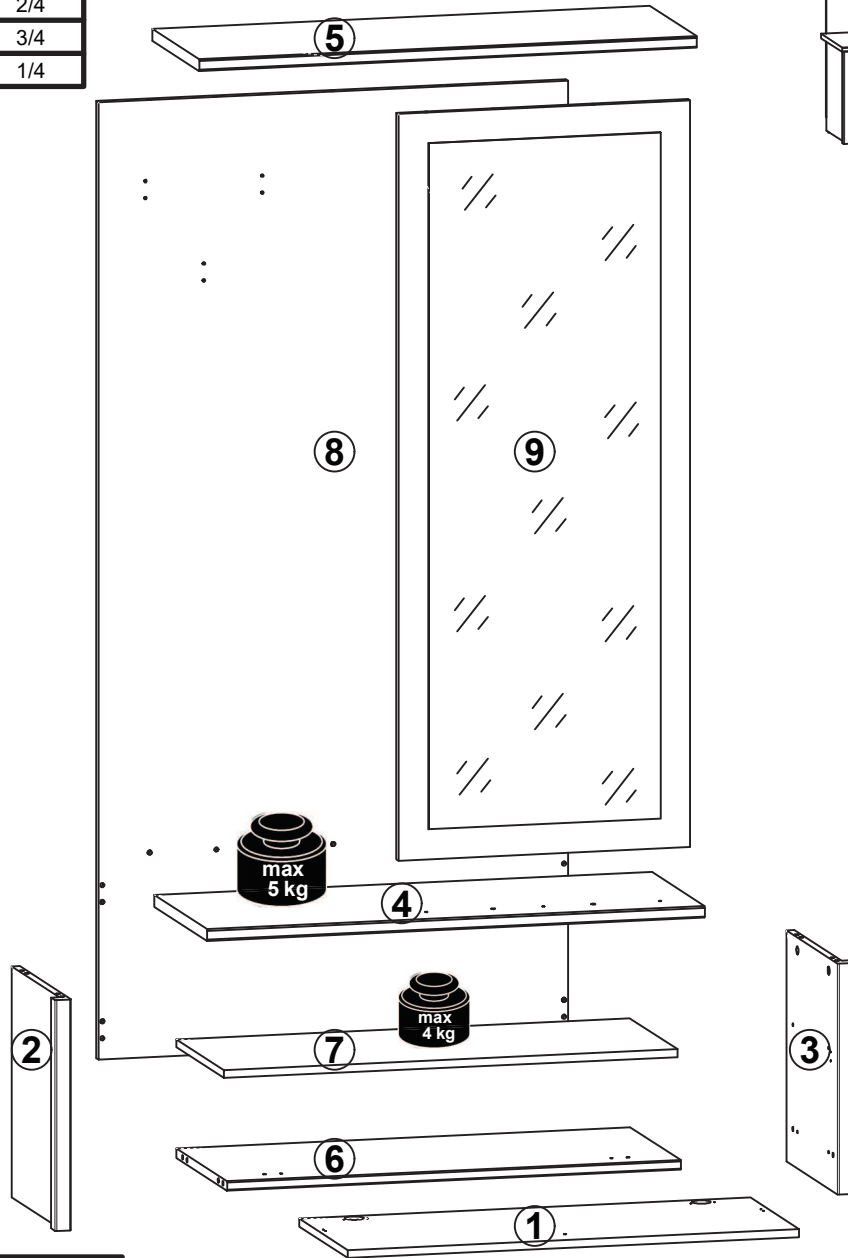
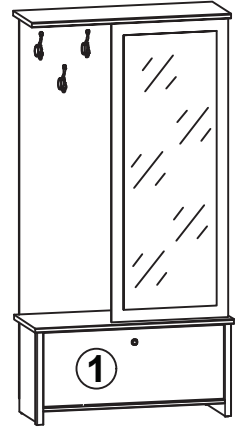
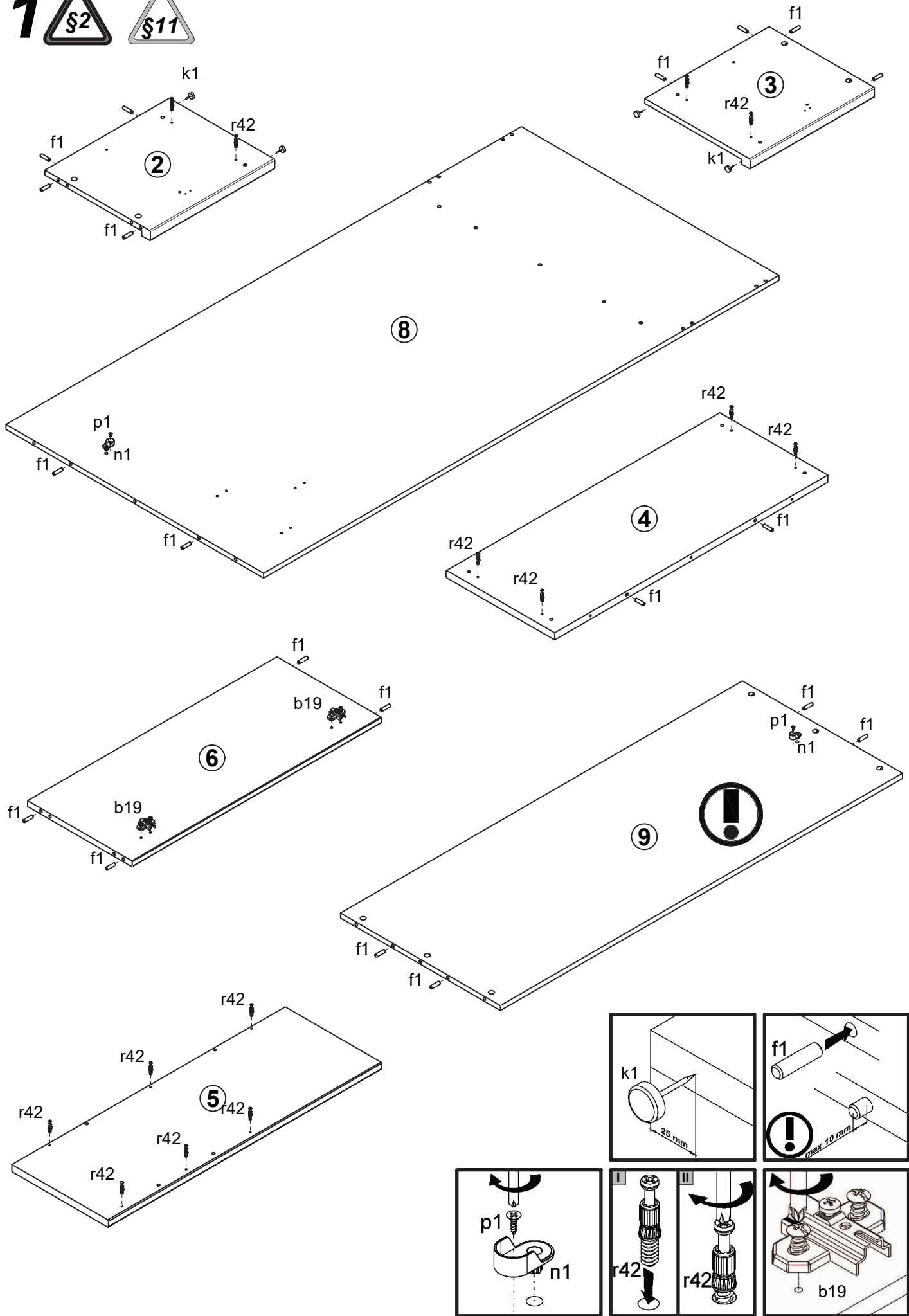



# 4

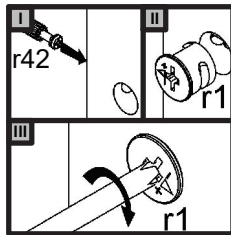
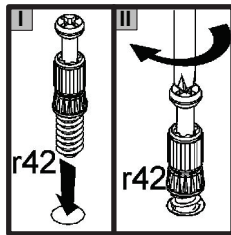
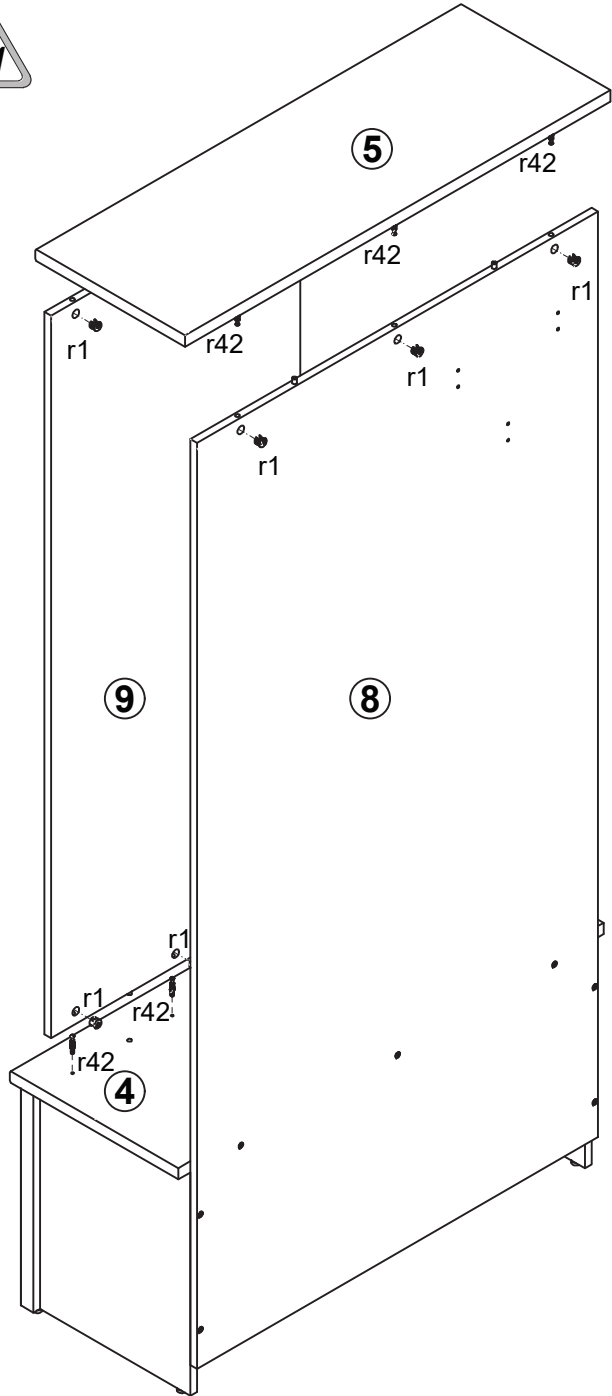

# 5

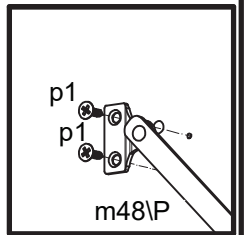
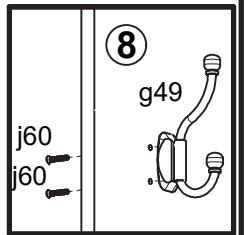
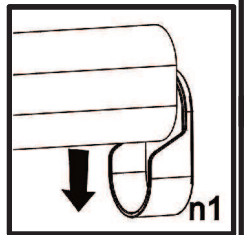
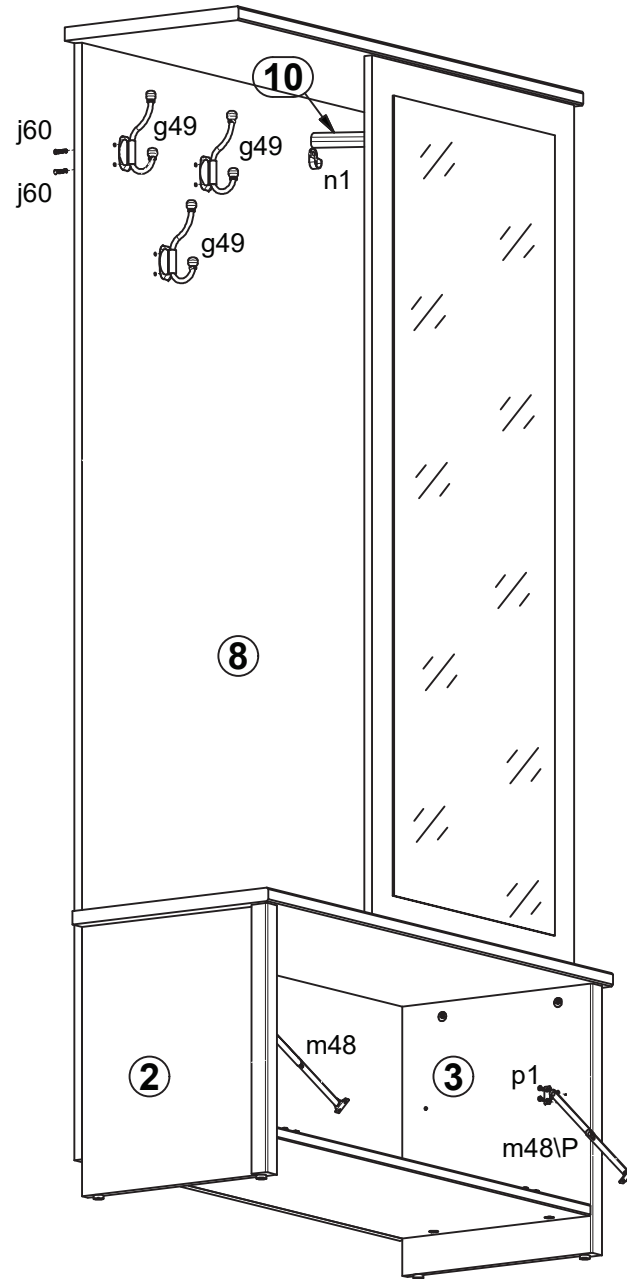

# 6

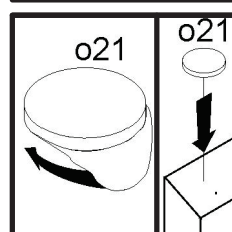
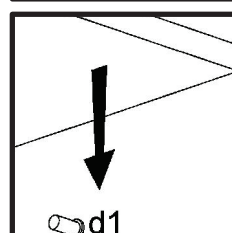
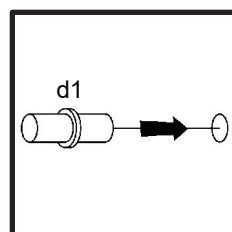
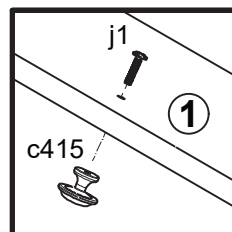
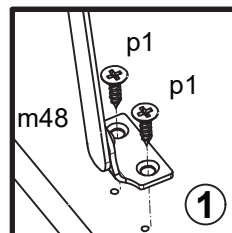
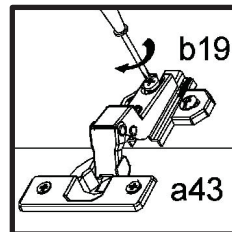
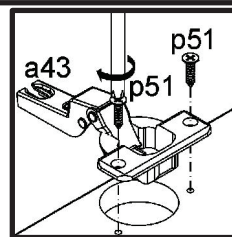
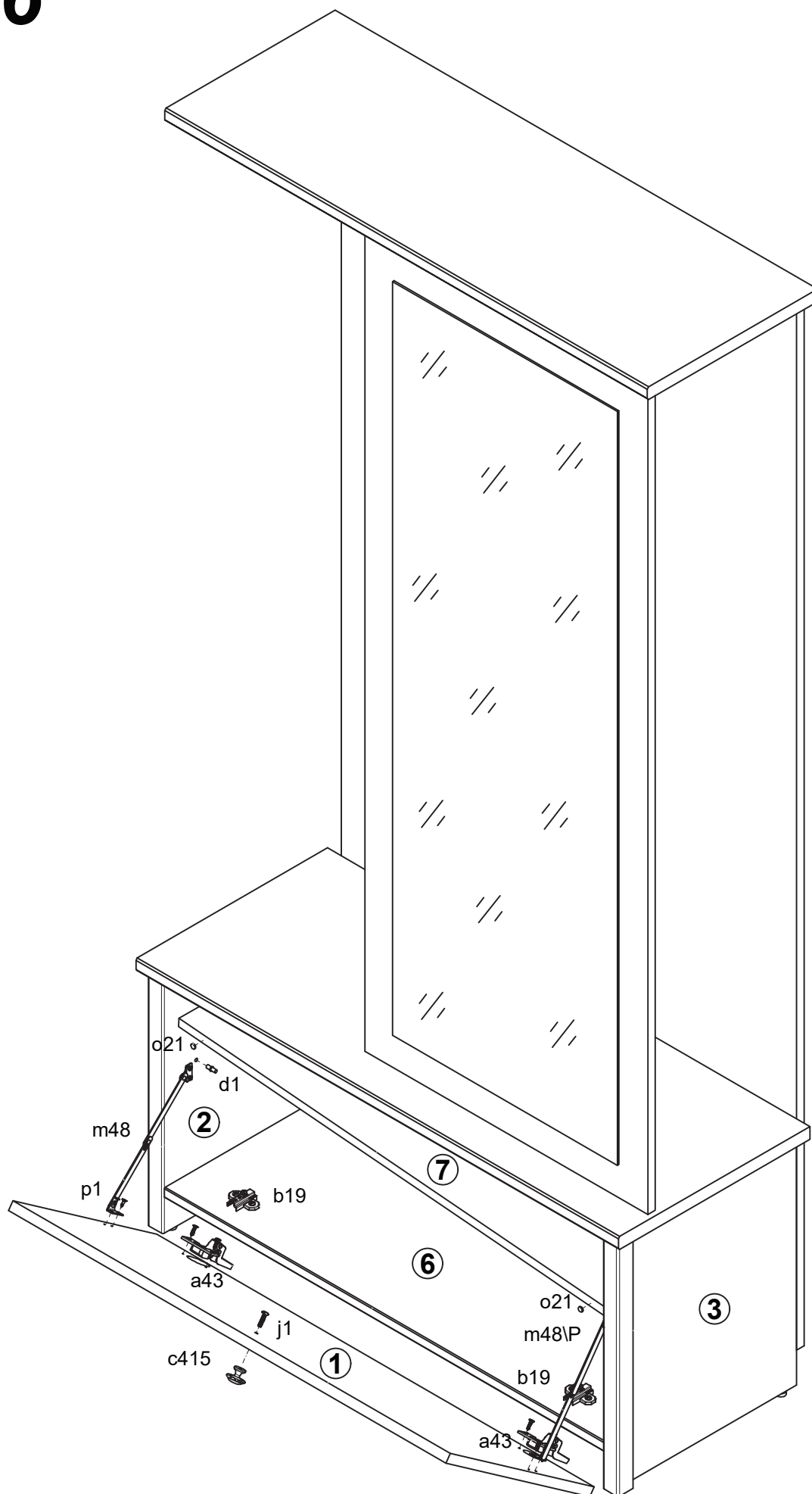

# 7

