

A	B	C		D
1	S440-0006/A	543	200	5/6
2	S440-0007/A	1860	543	5/6
3	S440-0008	1400	546	5/6
4	S440-1012	2014	540	1/6
5	S440-1013	2014	540	1/6
6	S440-1014/A	1939	520	2/6
7	S440-1015/A	460	520	4/6
8	S440-2003	1800	540	3/6
9	S440-3002	1769	520	3/6
10	S440-3003/A	1147	520	4/6
11	S440-3004	606	515	2/6
12	S440-3005	607	520	4/6
13	S440-3006	1147	520	4/6
14	S440-4013	1769	60	3/6
15	S440-4014	543	60	2/6
16	S440-5013	1950	80	2/6
17	S440-5014	1950	80	2/6
18	S440-5015	100	60	2/6
19	S440-5016	1802	80	1/6
20	S440-9005/A	507	503	2/6
21	S440-9006	1957	619	1/6
22	S440-9302	1957	1159	1/6
23	ZK3-5069	493	97	2/6
24	ZK4-529	500	110	2/6
25	ZK4-530	500	110	2/6
27	dr-1141	1141	30	2/6

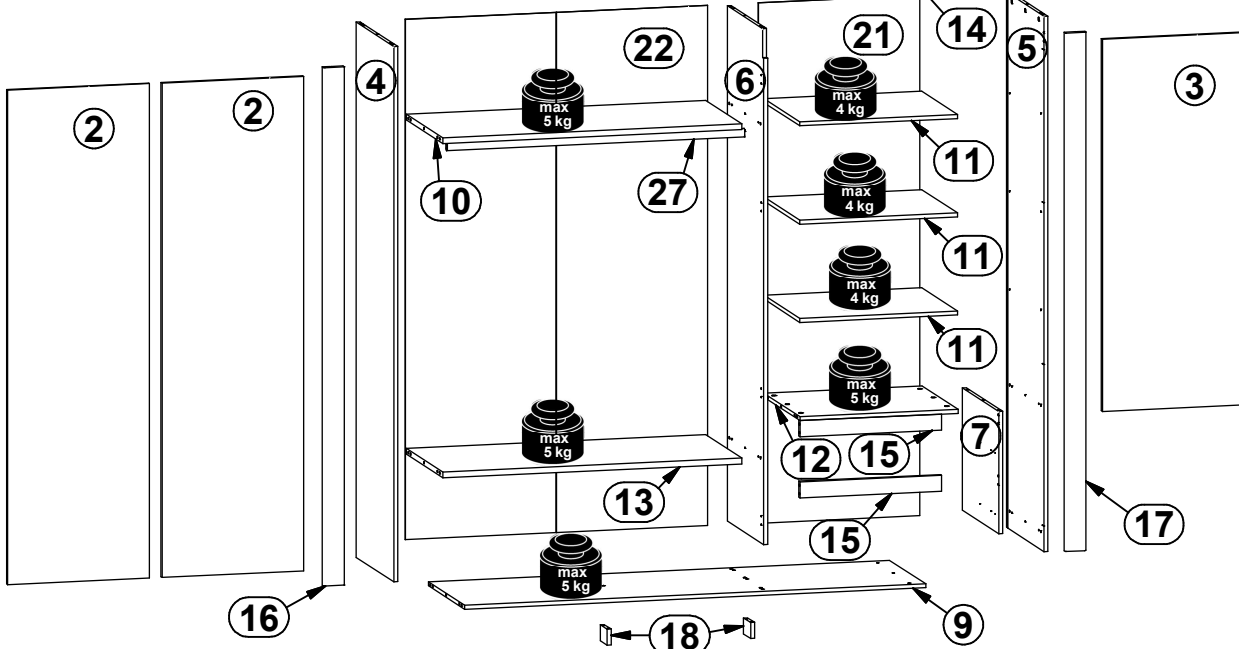

7x a132	4x a159	7x b43	4x b78	12x d1 Ø5x17 mm	5x d36	8x d37	8x e1 Ø7x50 mm	22x e2 Ø6,3x13 mm
44x f1 Ø8x30 mm	4x f9 Ø6x30 mm	8x f25 Ø6,5x40 mm	6x k1	45x l1 1,4x20 mm	14x i2	10x n108 22x9,5x20,7 mm	2x n158	2x p1 Ø3,5x13 mm
2x p25 Ø3,5x16 mm	2x p35 Ø3,5x10 mm	51x p38 Ø3,5x16 mm	22x p51 Ø3,5x15 mm	10x p55 Ø2,9x16 mm	24x p140 Ø3,5x12 mm	18x r1 Ø15x12 mm #16	12x r3 Ø15x15 mm #22	8x r15 Ø12x10,5 mm #12
38x r42 20/11	2x t34 500 mm	4x w23111 L=500 mm	4x w23112 L=500 mm	3x z2811 Ø2x9,5x6,5 mm	3x z2812 Ø2x9,5x6,5 mm	3x z2813 20x20x1,5 mm	9x z2814 Ø3x12 mm	4x s1
18x s2 Ø16	1x z1 4 mm	1x n2611						

1 

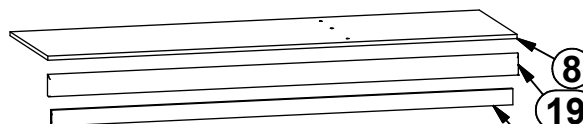
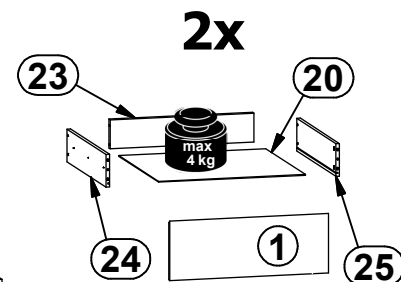
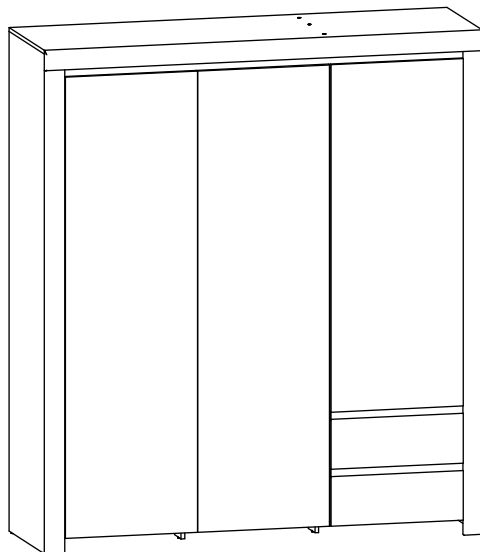
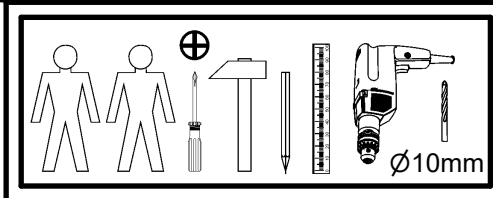
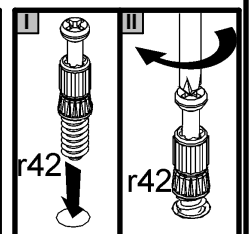
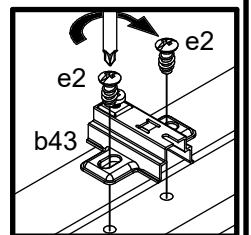
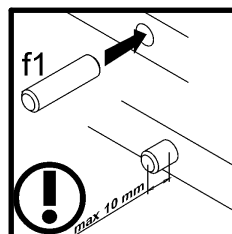
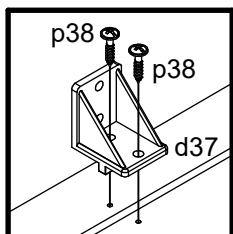
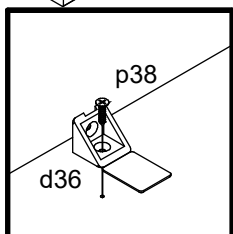
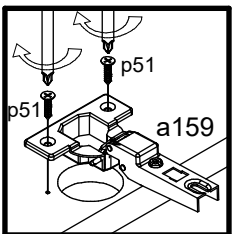
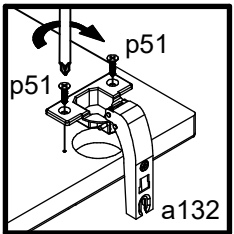
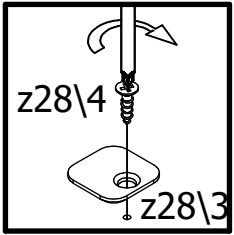
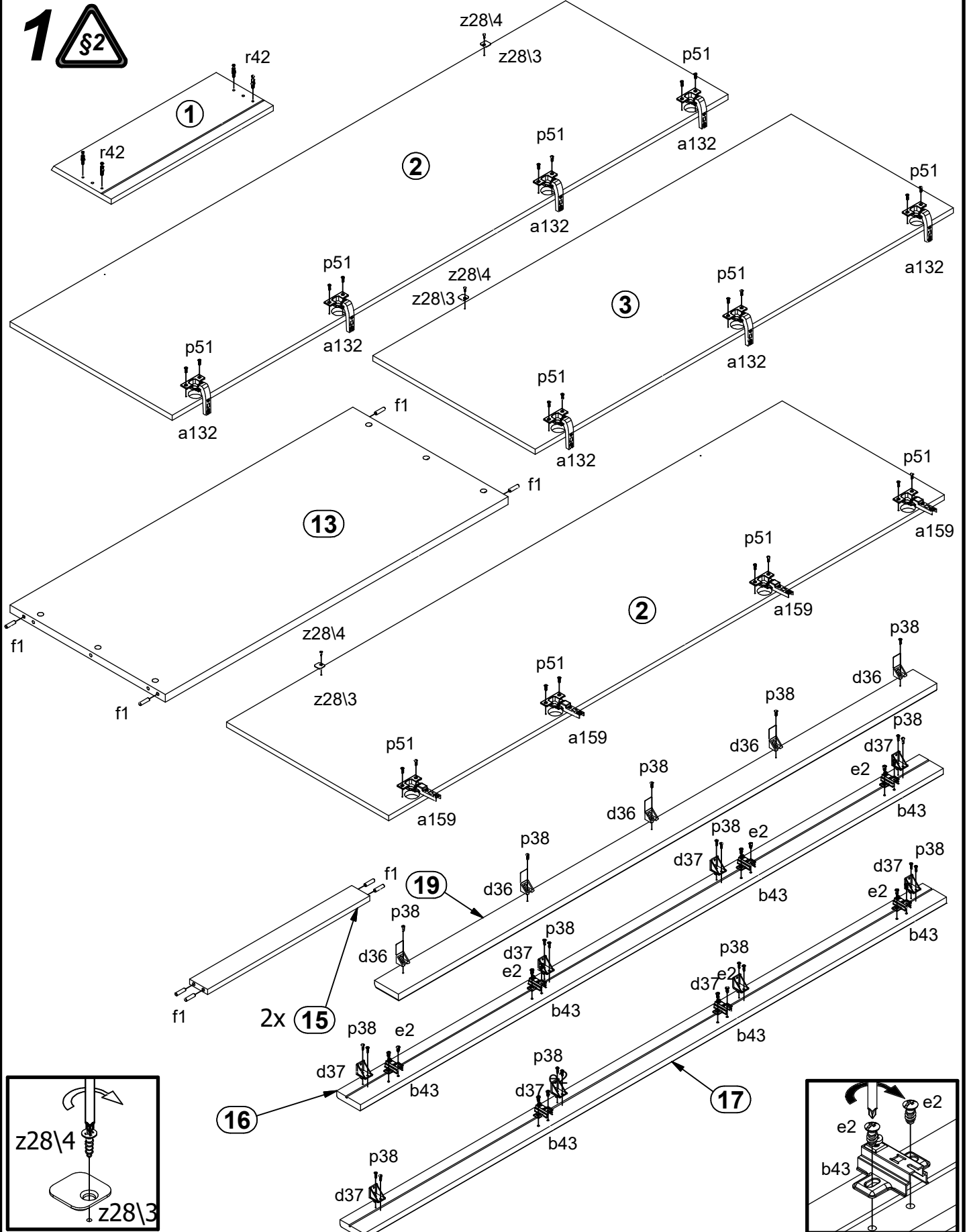

2

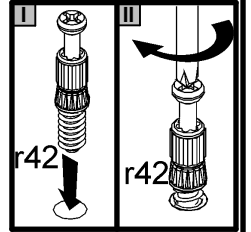
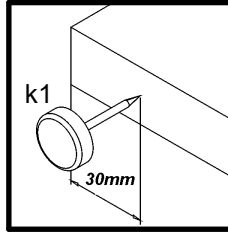
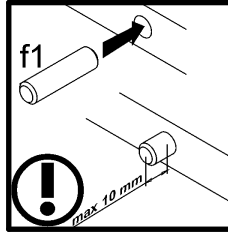
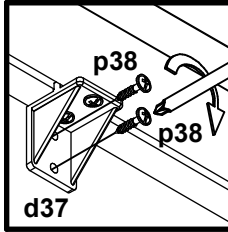
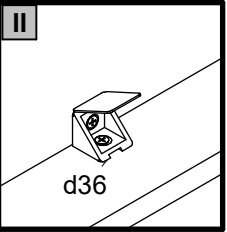
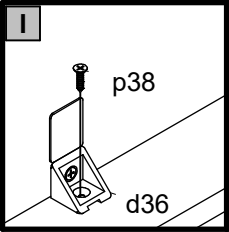
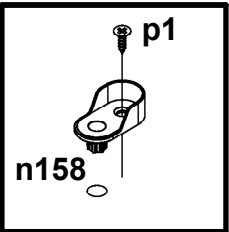
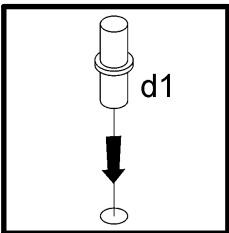
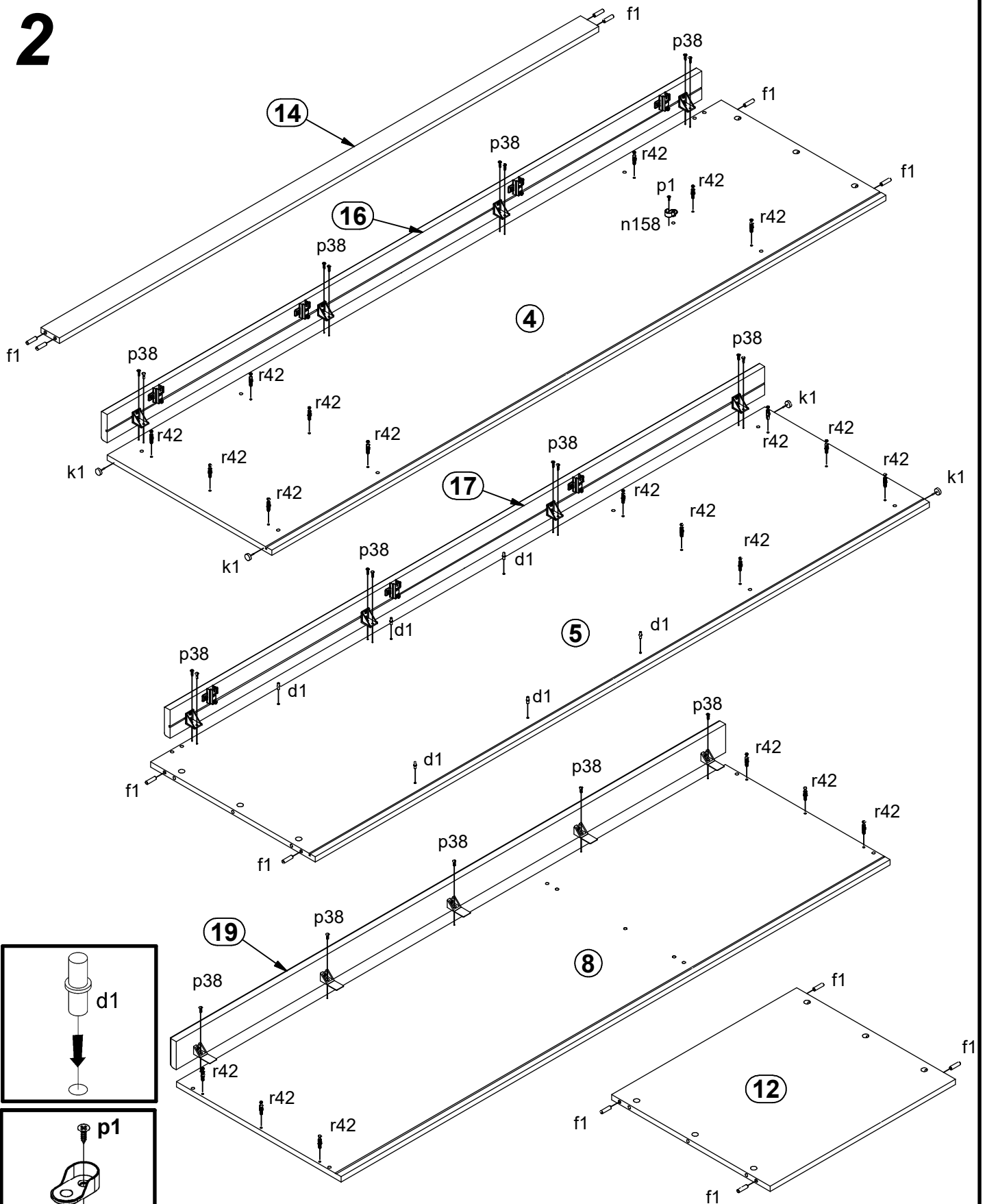

3

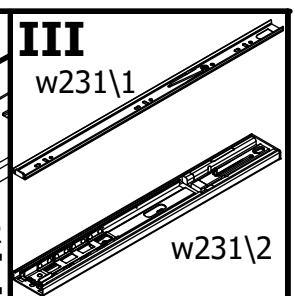
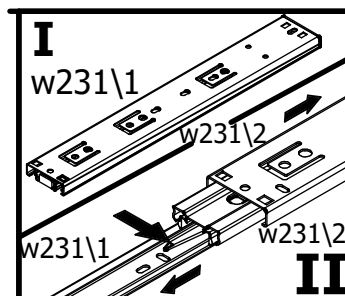
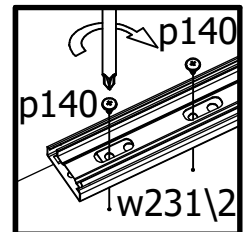
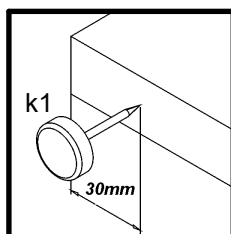
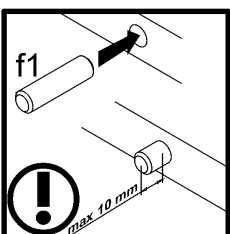
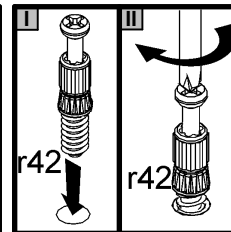
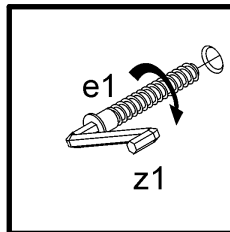
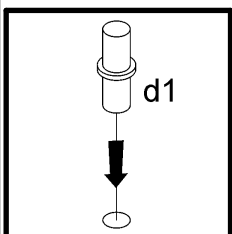
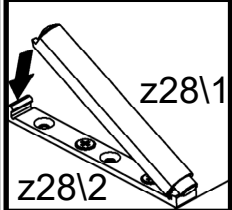
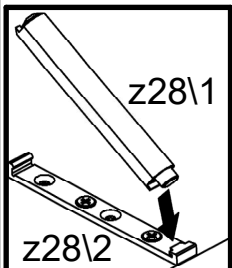
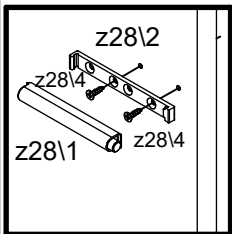
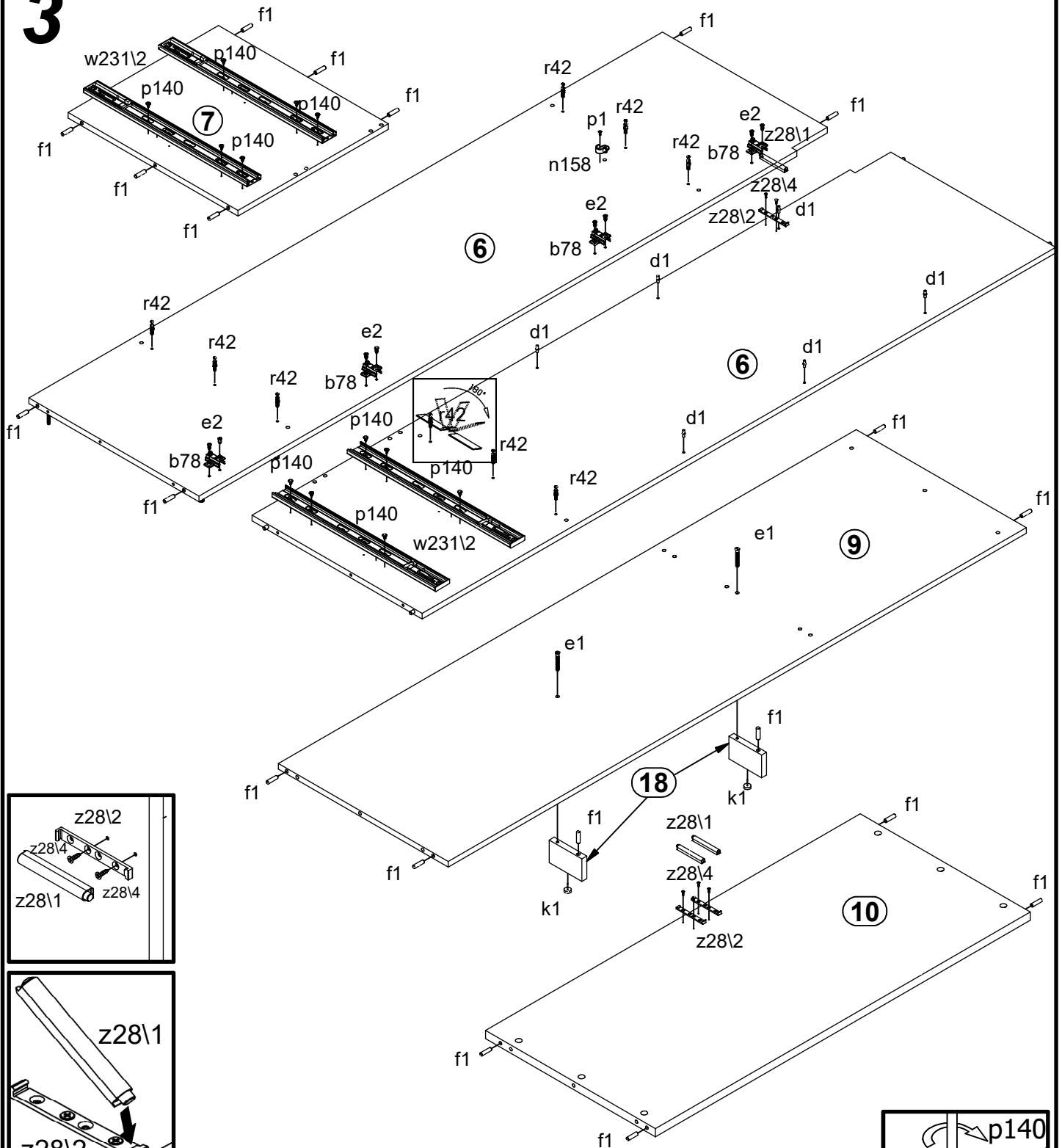

4

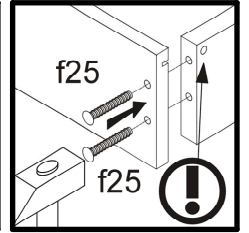
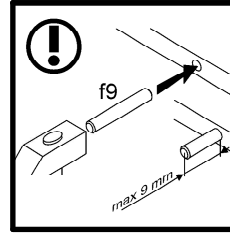
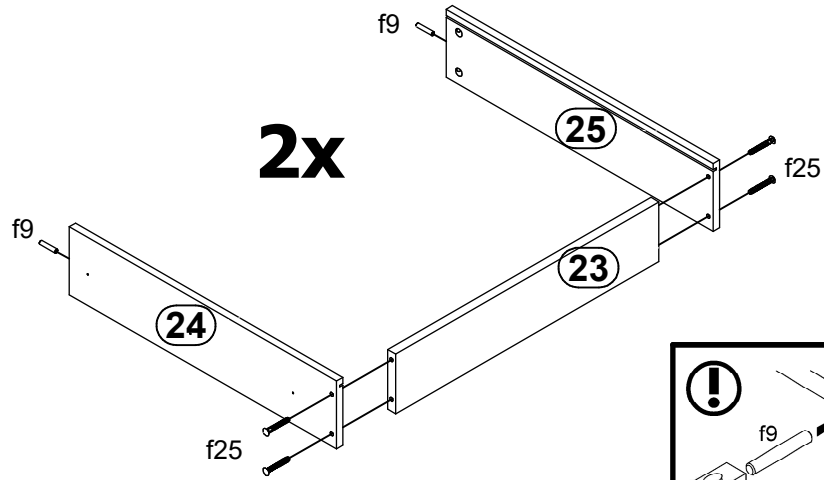

5

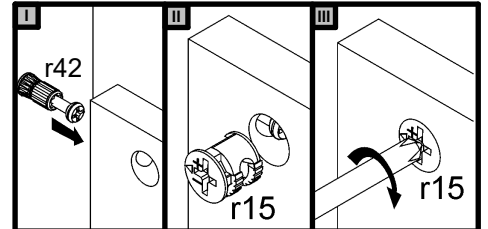
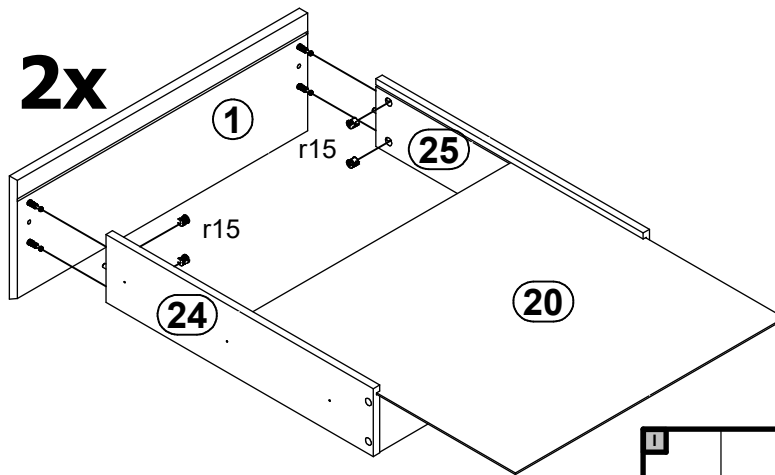

6

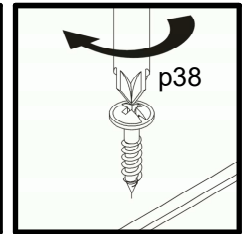
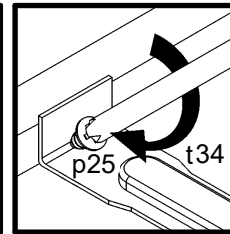
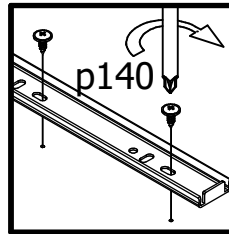
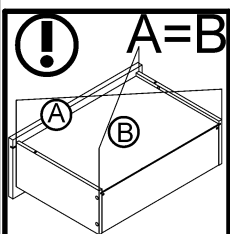
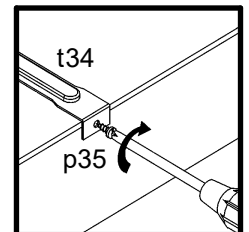
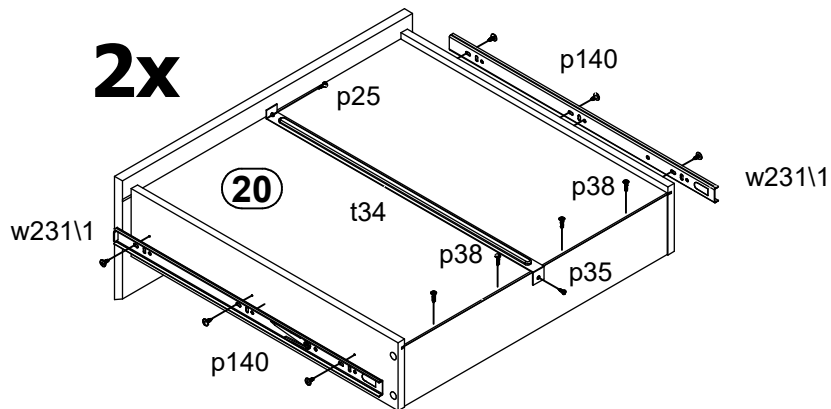

7

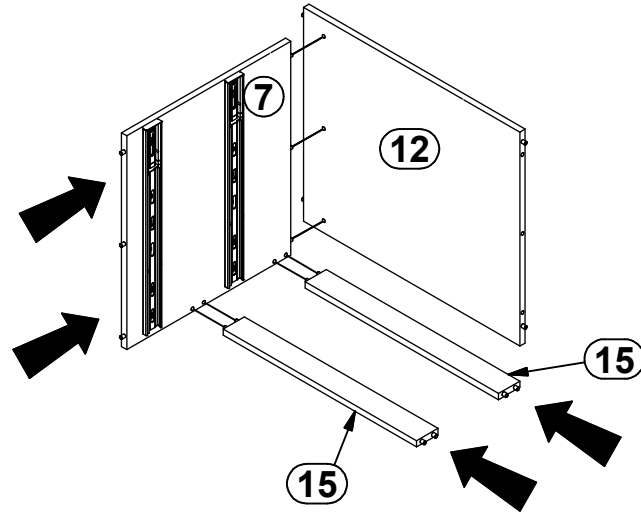

8

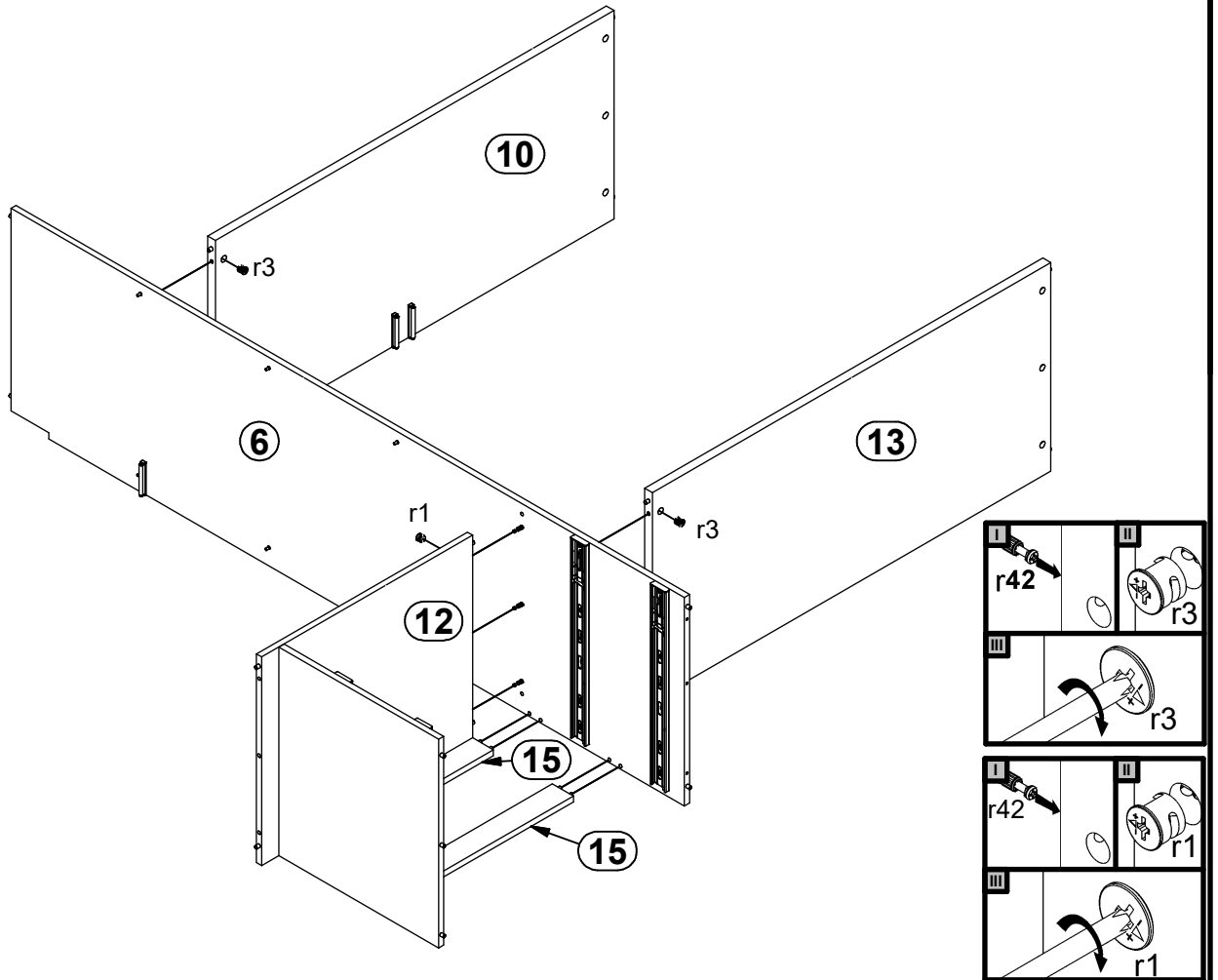

9

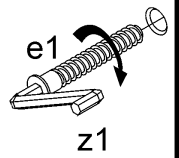
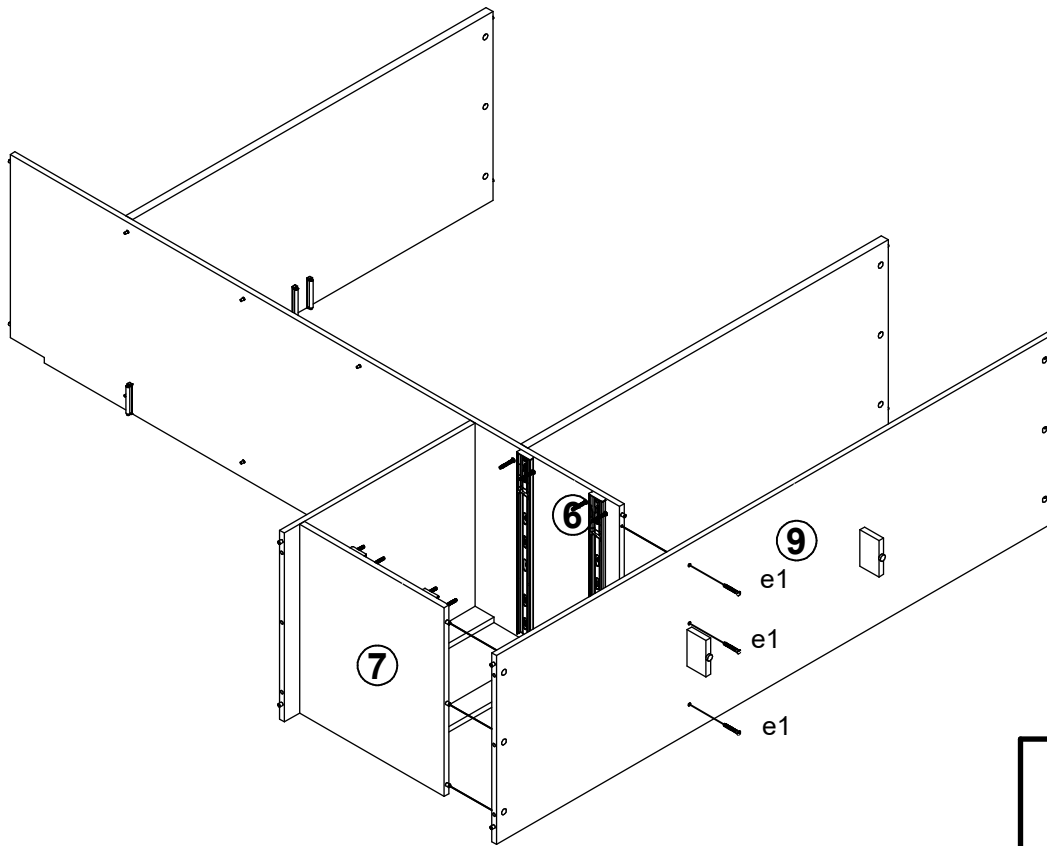

10

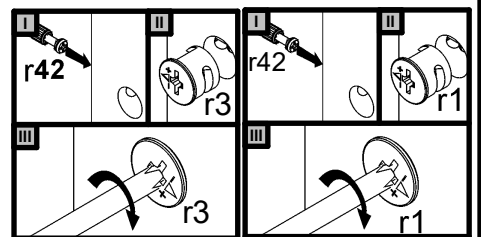
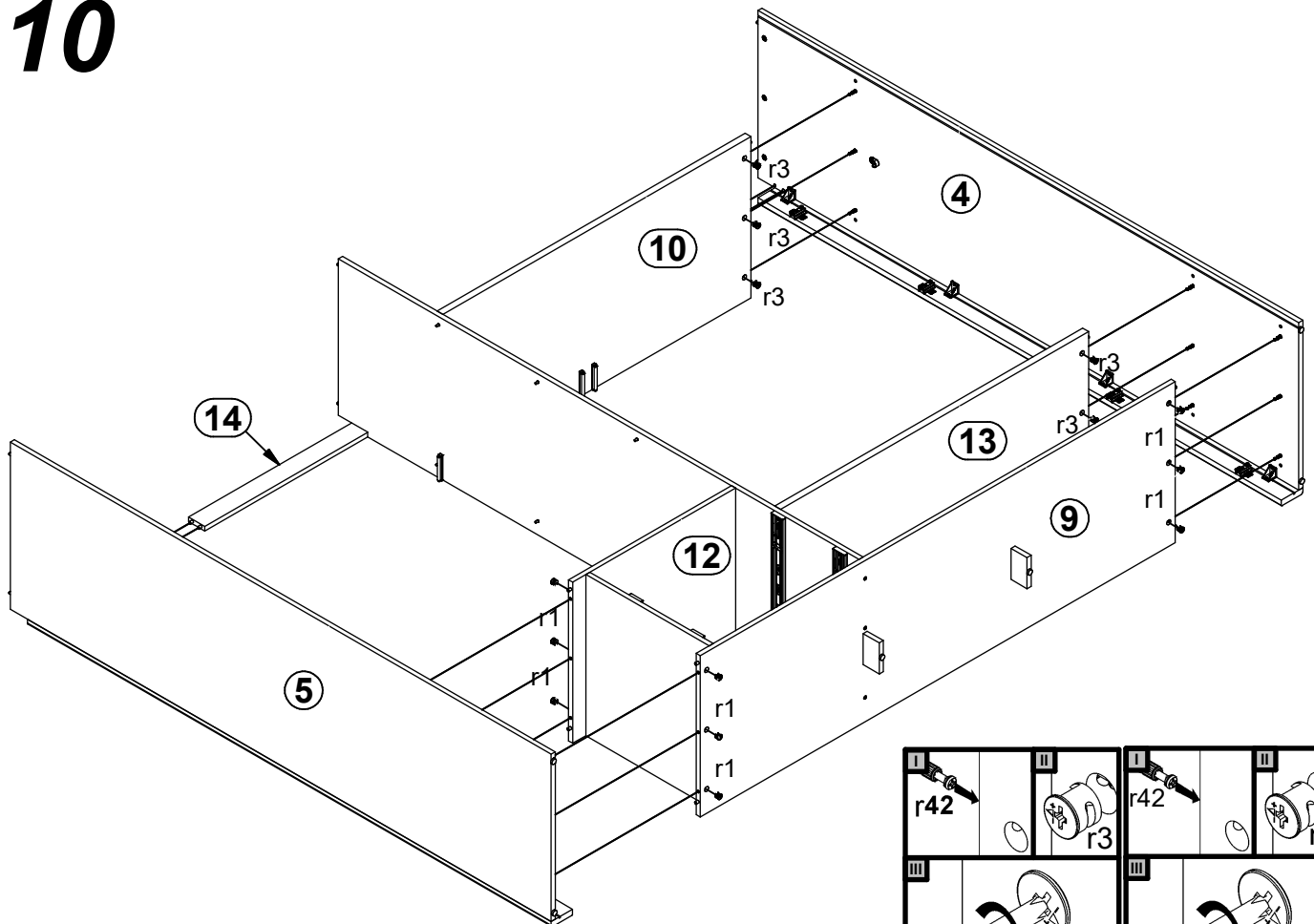

11

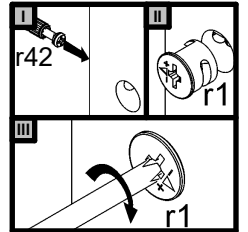
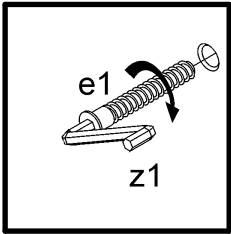
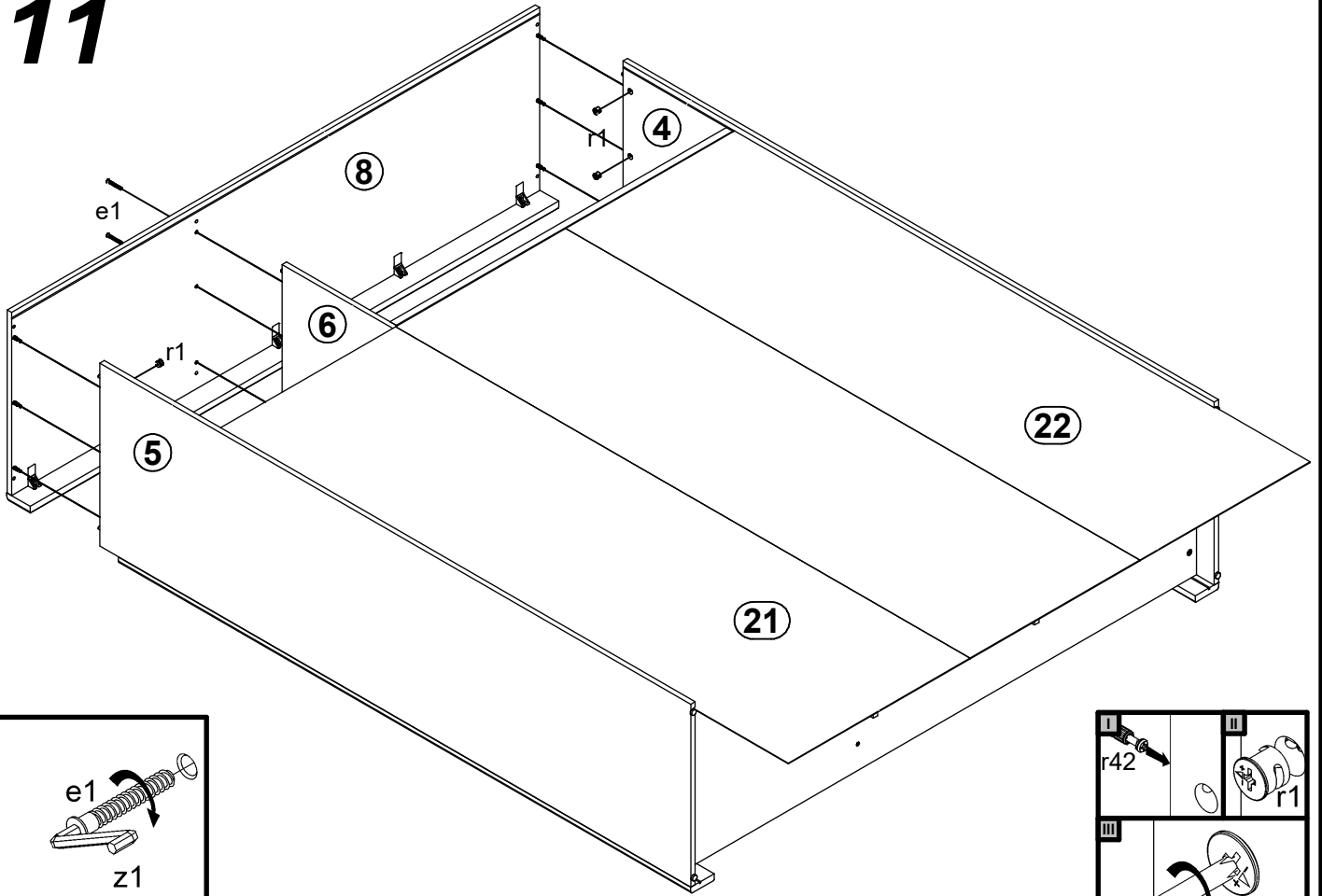

12

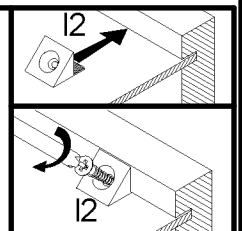
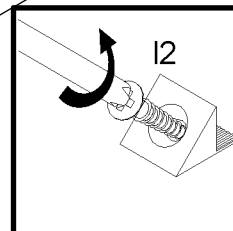
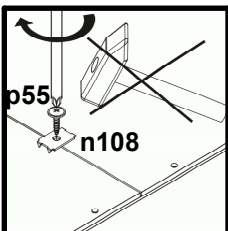
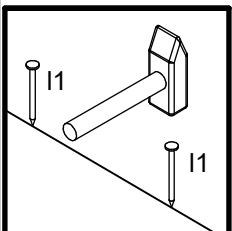
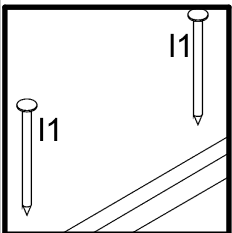
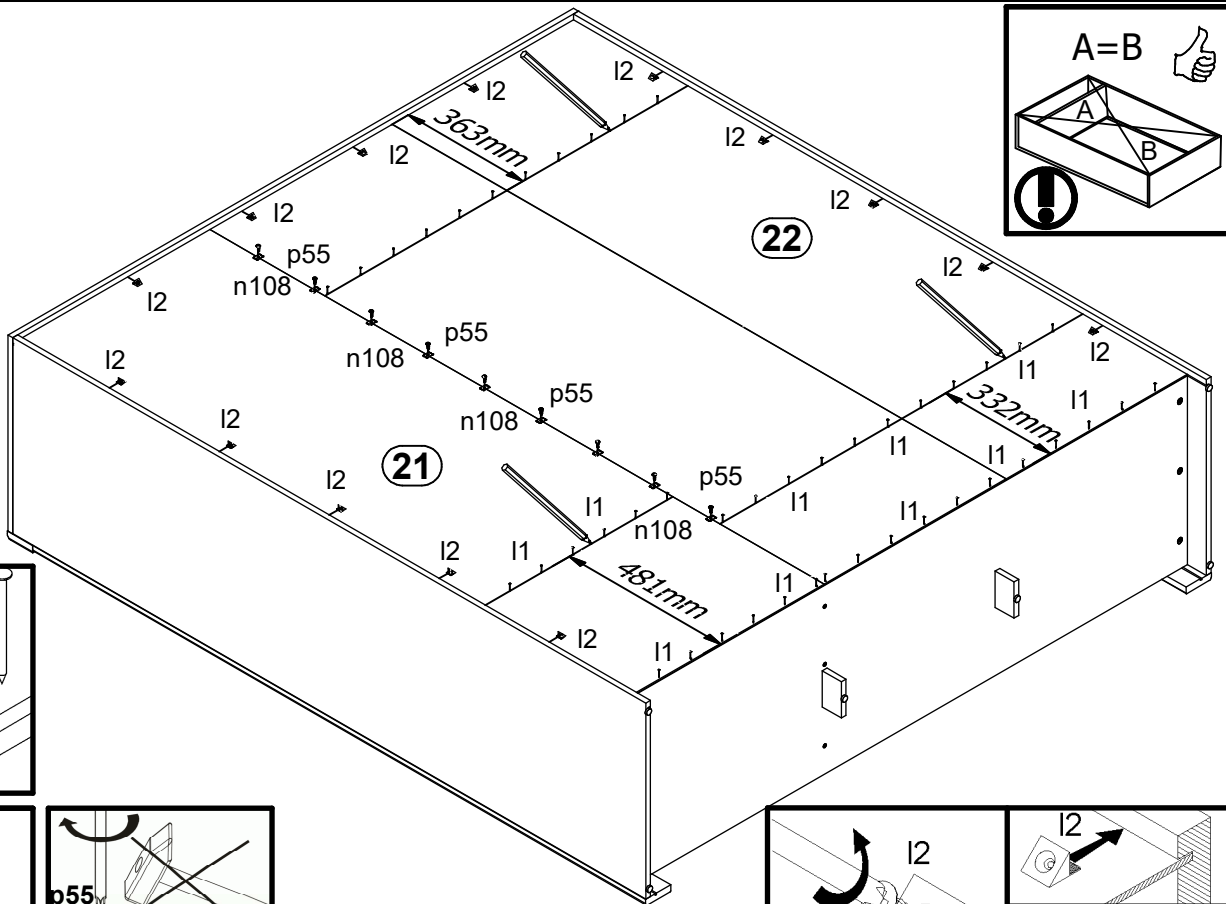

13

