

A**D05034-LAW/50**

| A | B | C | D |
|---|-----------------|-----|-----|
| 1 | D05034-20 02 | 500 | 500 |
| | | | 1/2 |

**1**

2

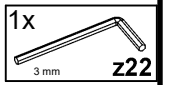
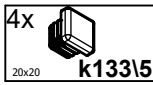
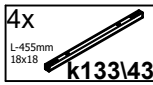
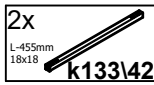
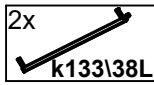
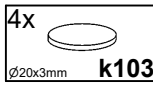
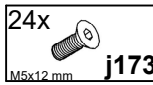
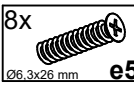
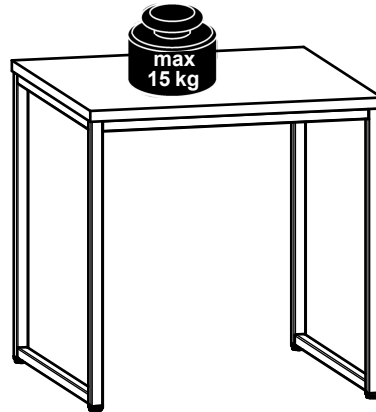
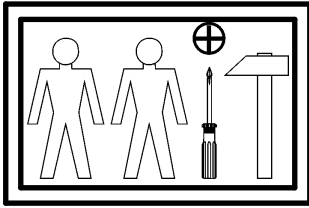
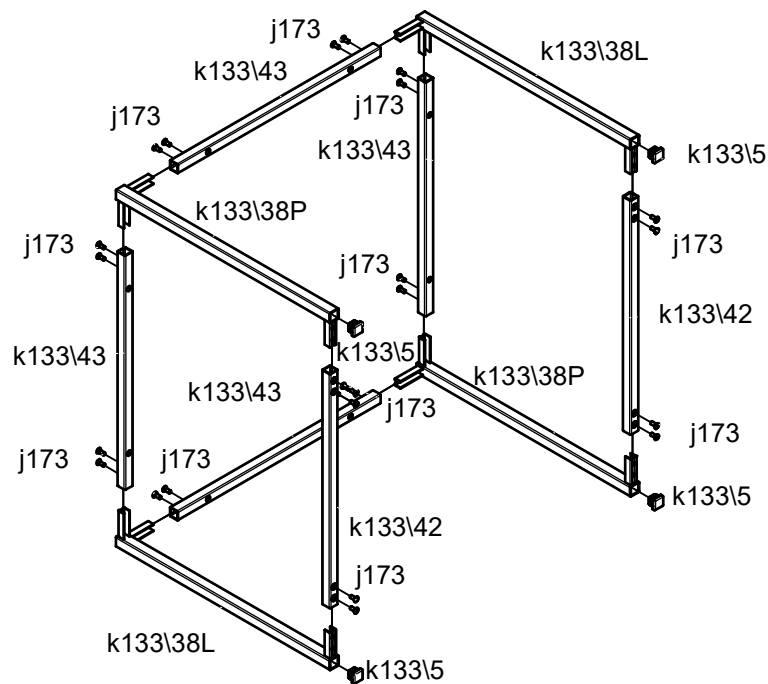