

F24-FRN/153

| A | B | C | D |
|---|---------|-----|---------|
| 1 | F24-003 | 775 | 710 1/1 |



F24-FRN/153-LUS

| A | B | C | D |
|---|---------|-----|---------|
| 2 | F24-008 | 775 | 710 1/1 |

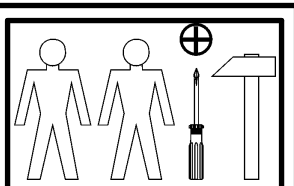
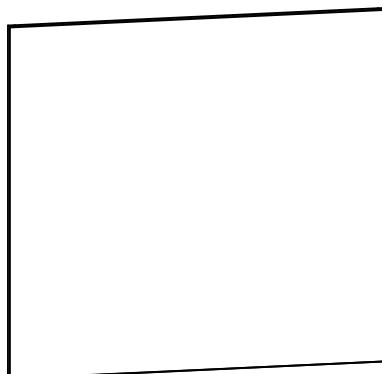
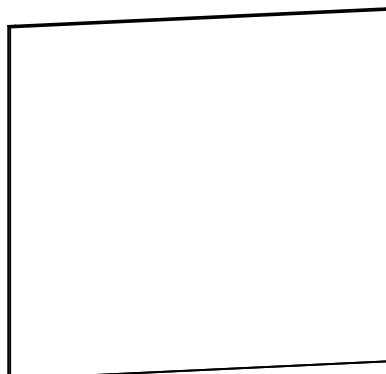
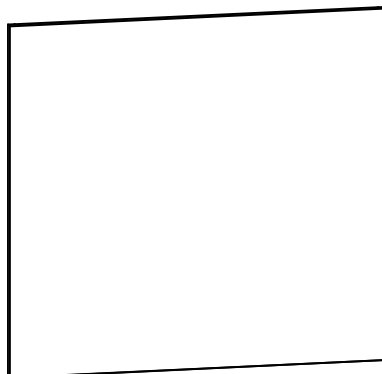
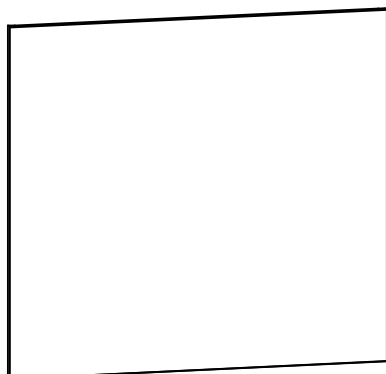
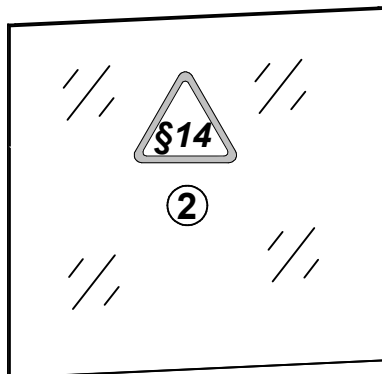
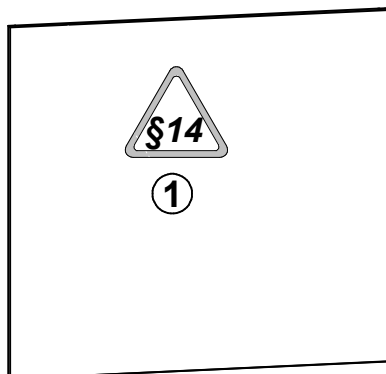
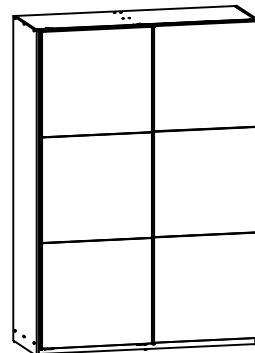

1

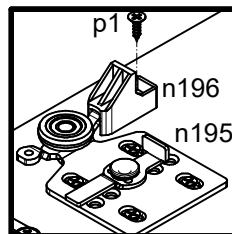
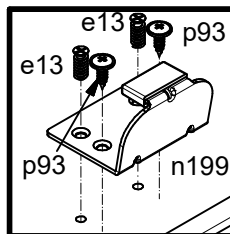
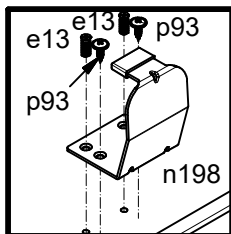
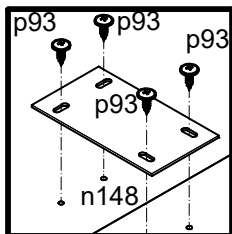
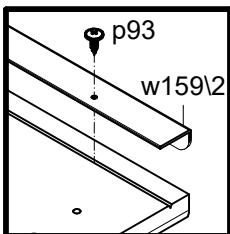
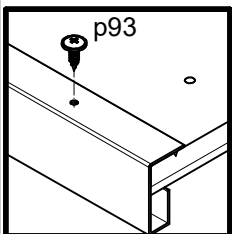
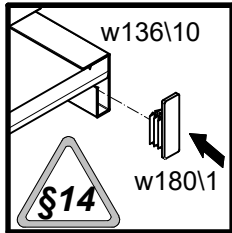
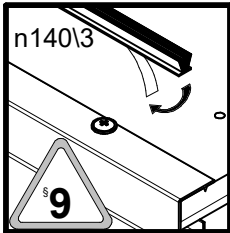
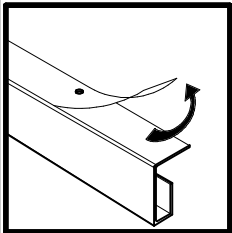
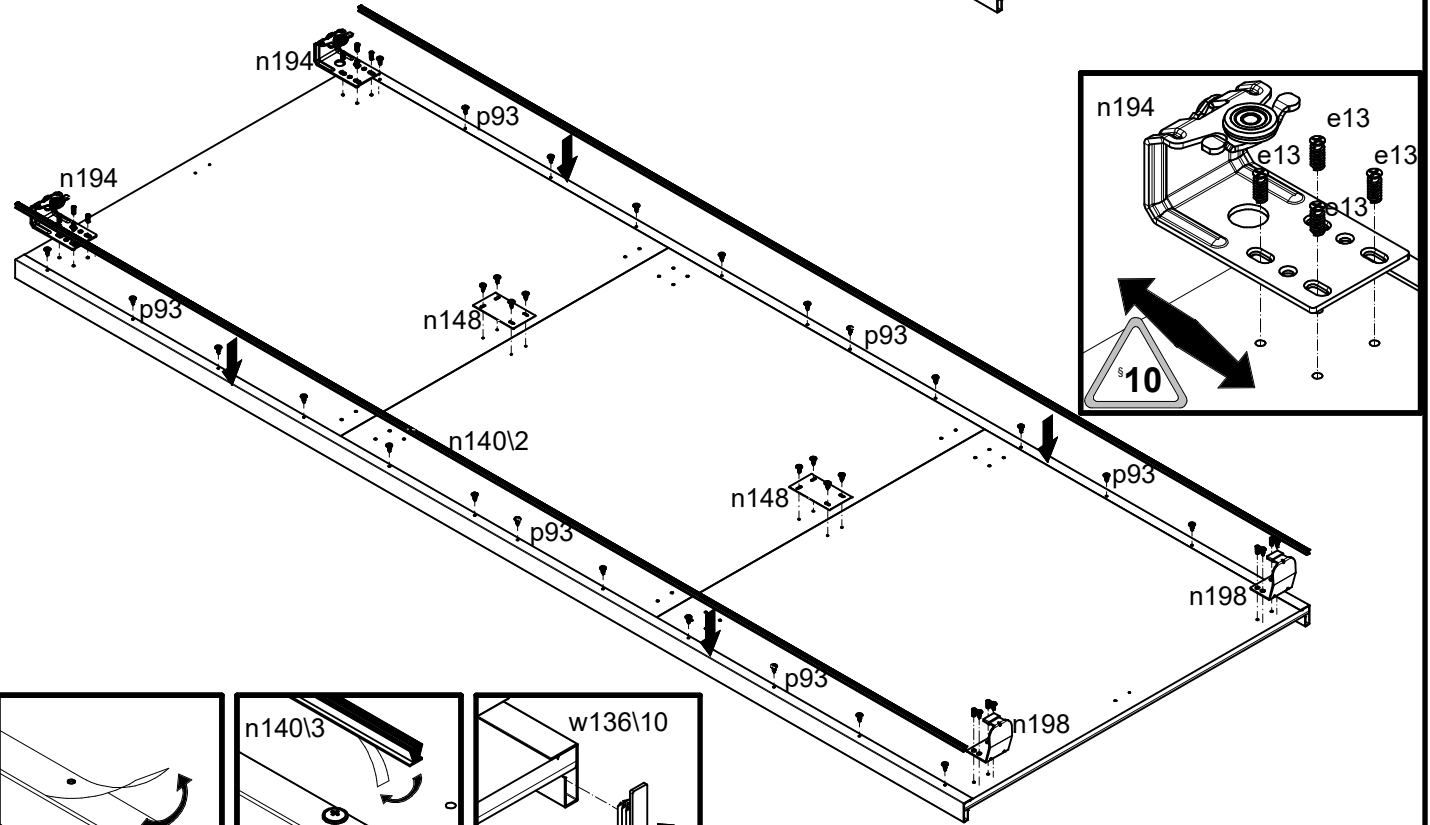
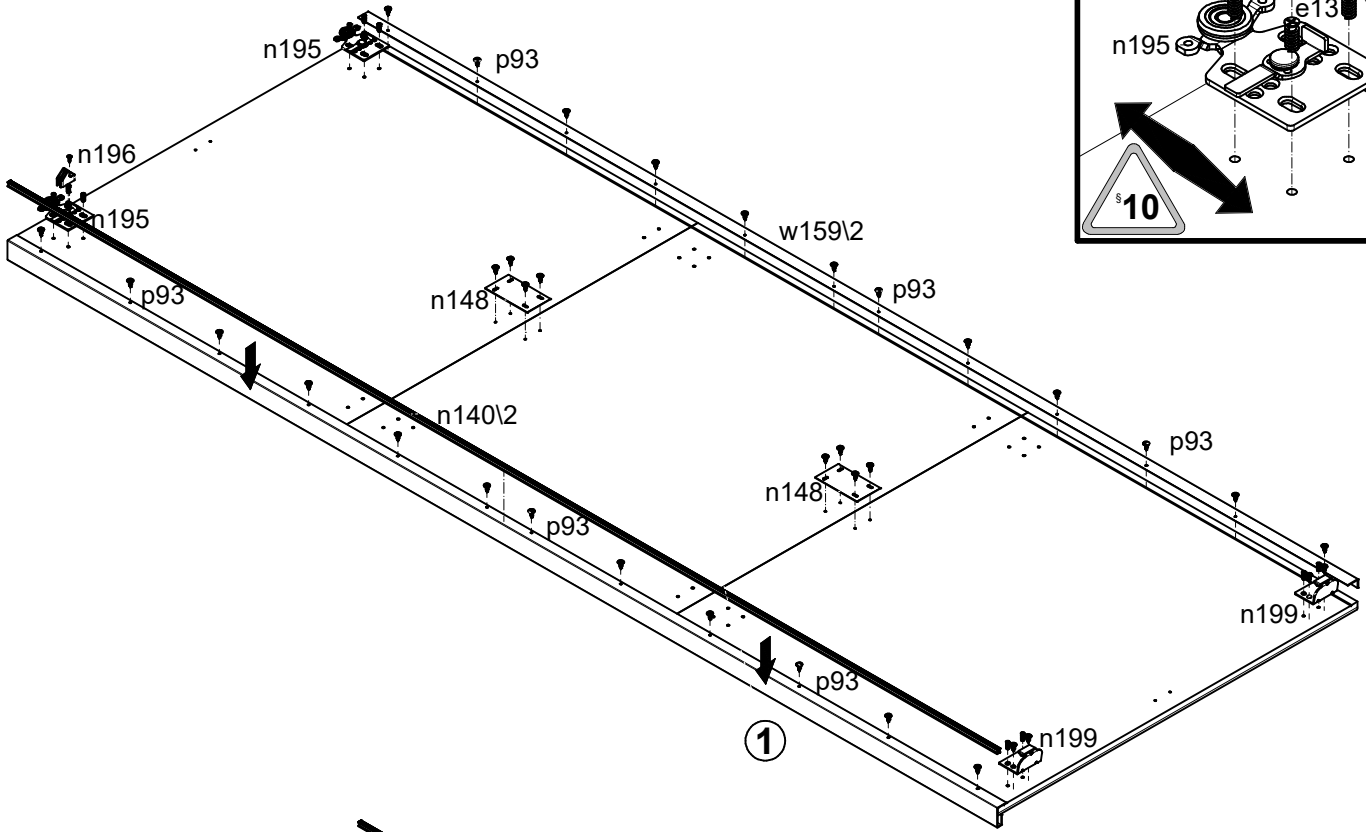

2

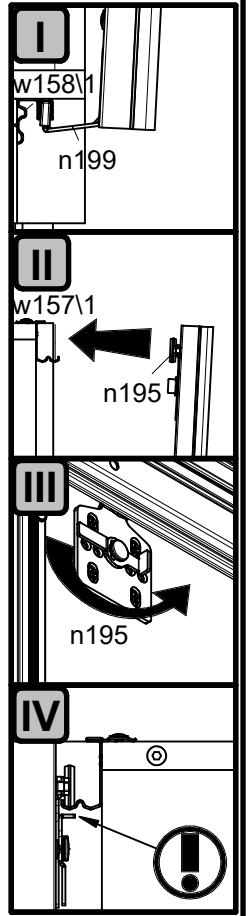
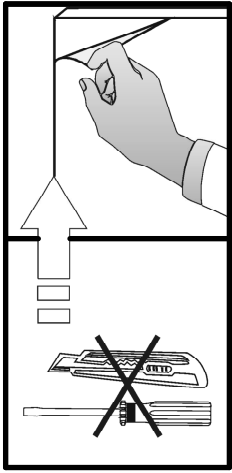
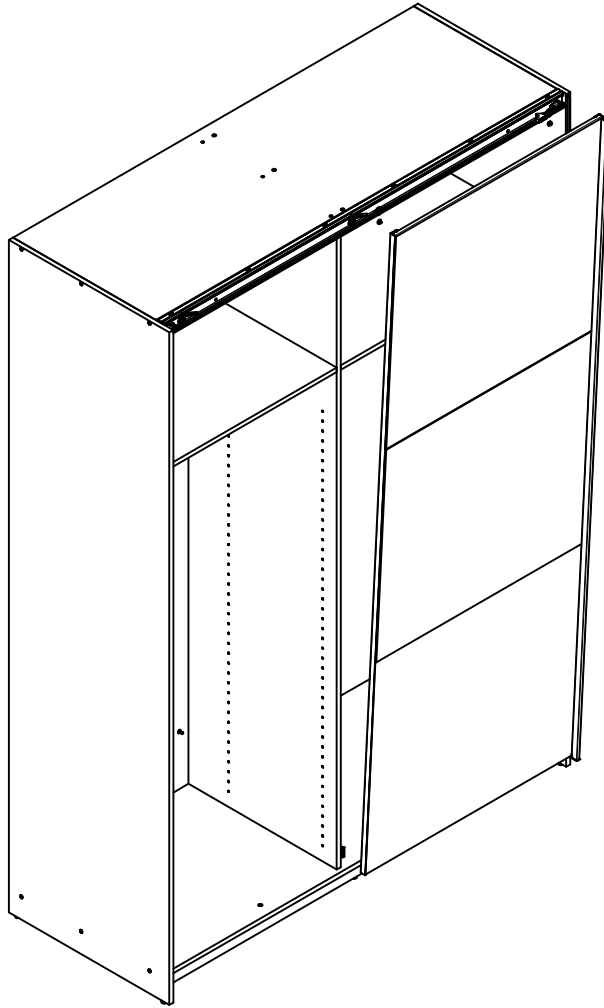

3

