

A	B	C	D	
1	S337-0008	446	1859	4/4
2	S337-1012	1978	540	1/4
3	S337-1013	1978	540	1/4
4	S337-2004	1030	540	2/4
5	S337-3006	997	540	2/4
6	S337-3022	997	540	2/4
7	S337-4004	901	50	2/4
8	S337-4010	997	68	2/4
9	S337-5004	1031	65	3/4
10	S337-5010	1995	65	3/4
11	S337-5011	1995	65	3/4
12	S337-9304	1920	1021	1/4
13	dr-992	992	30	2/4

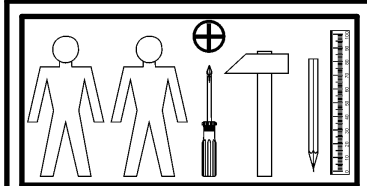

6x a99	6x b43	2x c431 160 mm	12x e2 Ø6.3x13 mm	26x f1 Ø8x30 mm	4x j30 M4x22 mm	4x k1	60x l1	1x n26
2x n158	2x p1 Ø3.5x13 mm	1x p38 Ø3.5x16 mm	12x p51 Ø3.5x15 mm	3x p94 Ø4x28 mm	34x r1 Ø15x12 mm #16	2x r10	30x r42 20/11	24x s2 Ø16

1

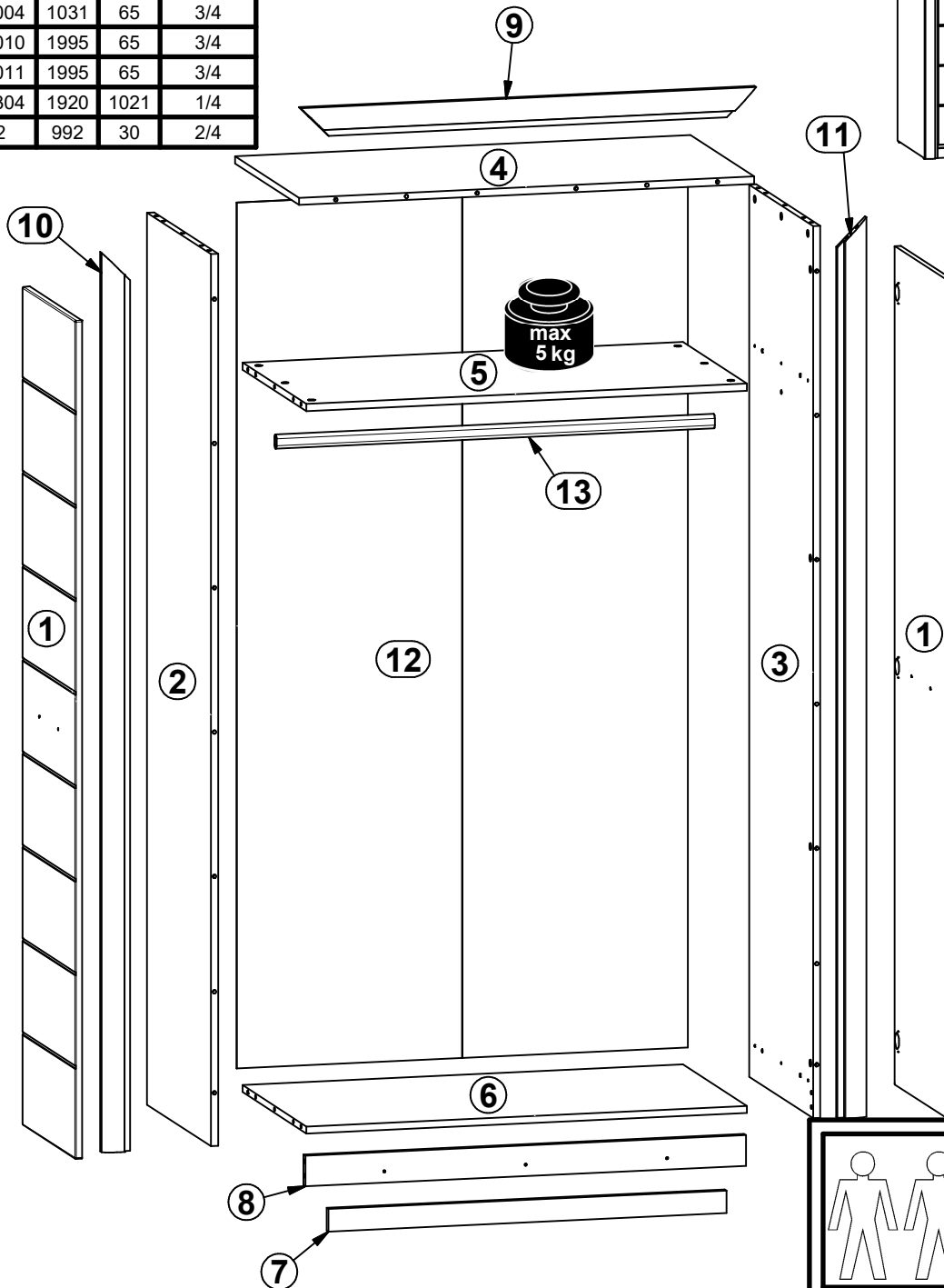
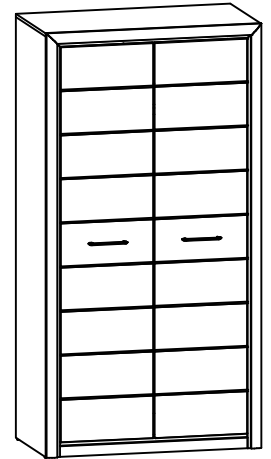
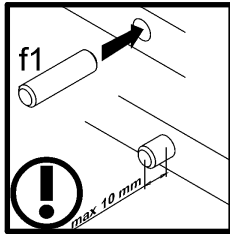
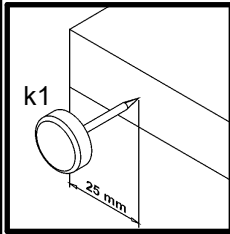
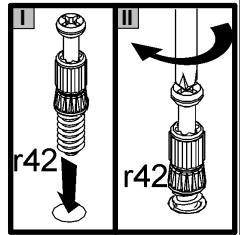
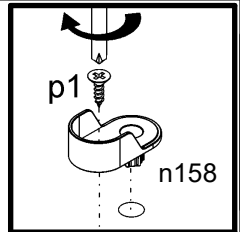
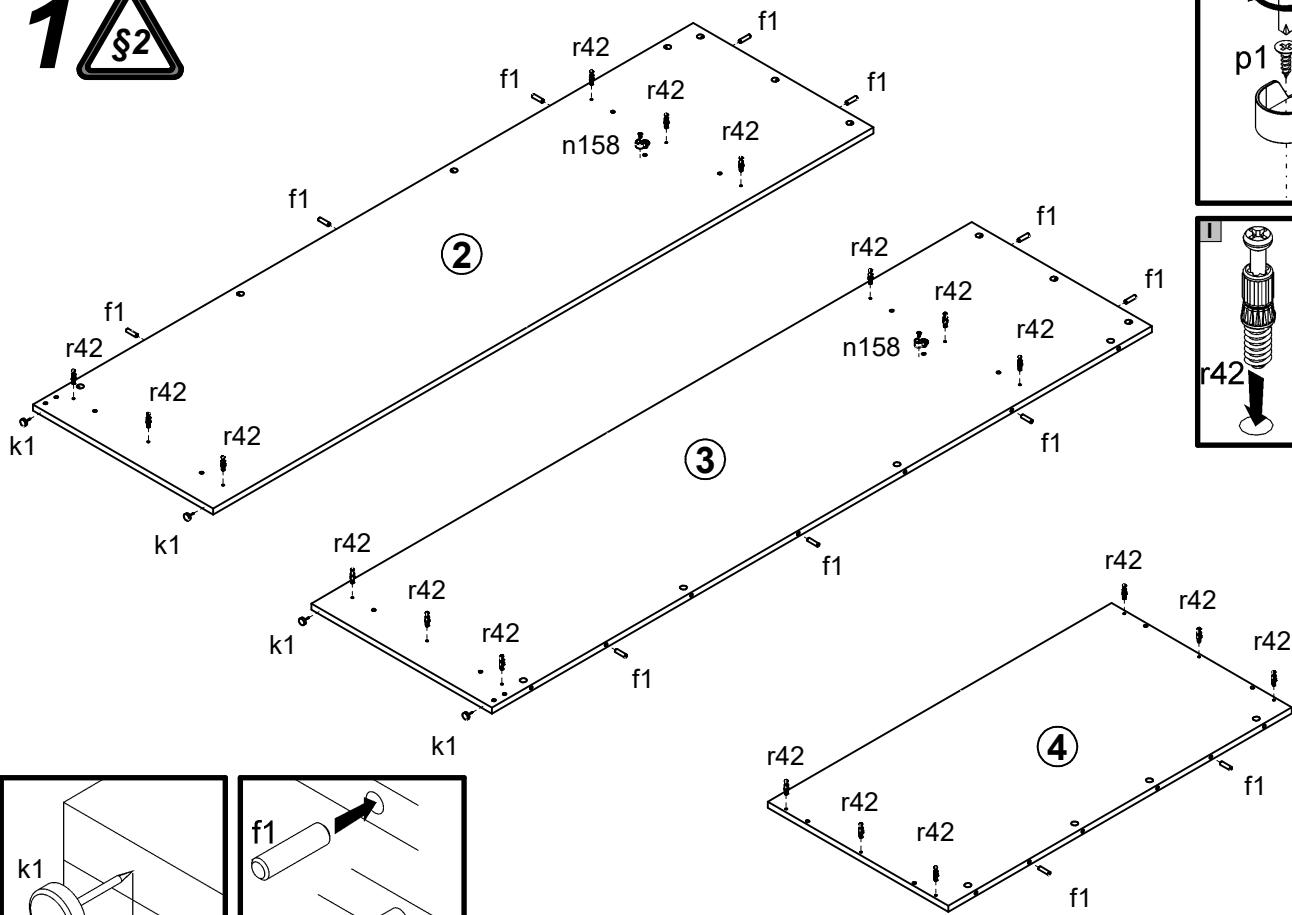

2

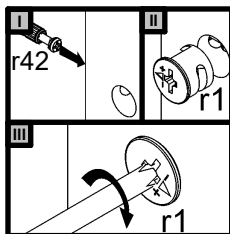
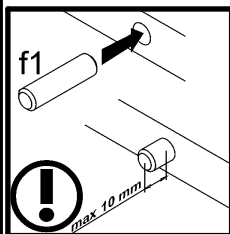
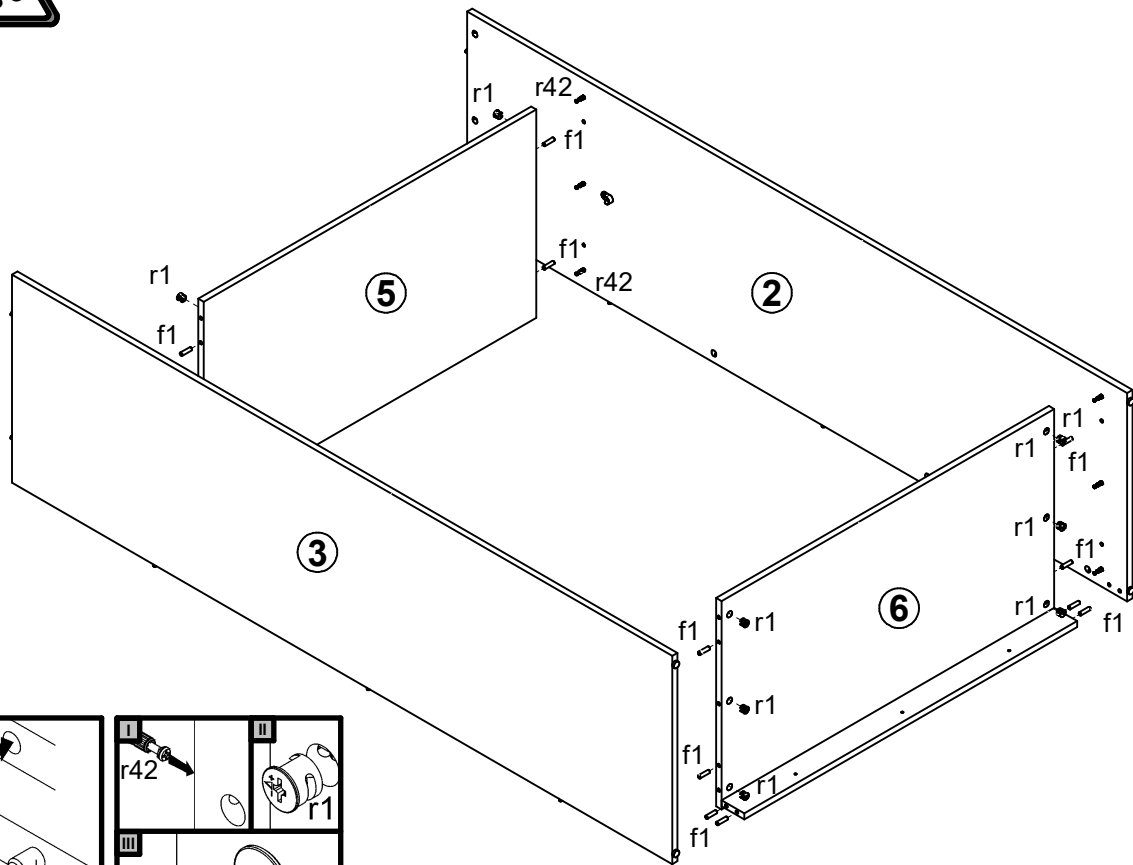

3

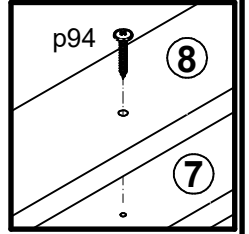
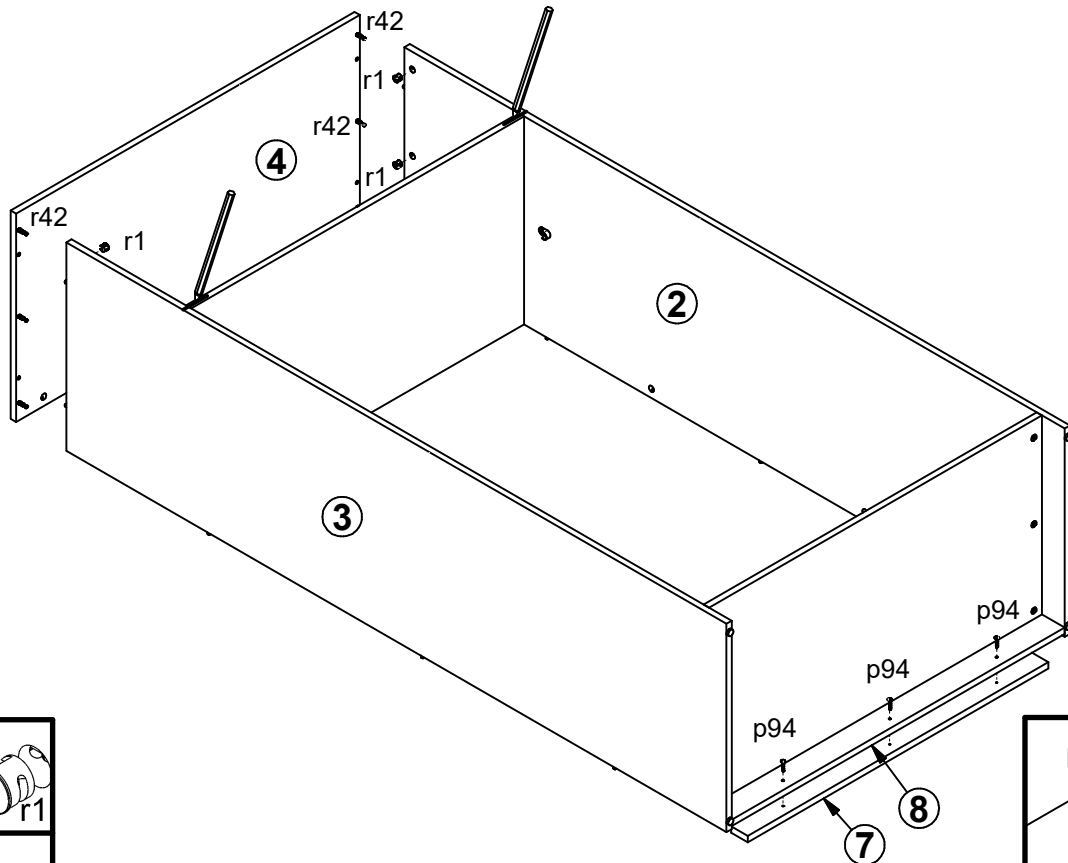

4

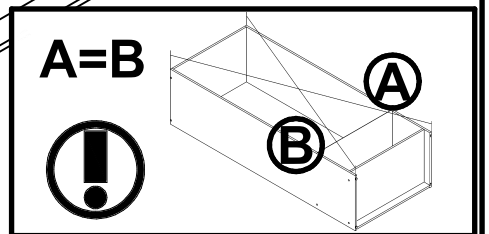
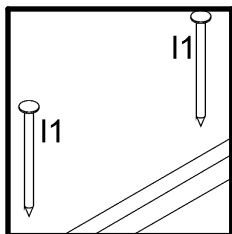
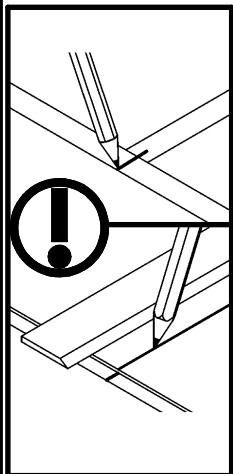
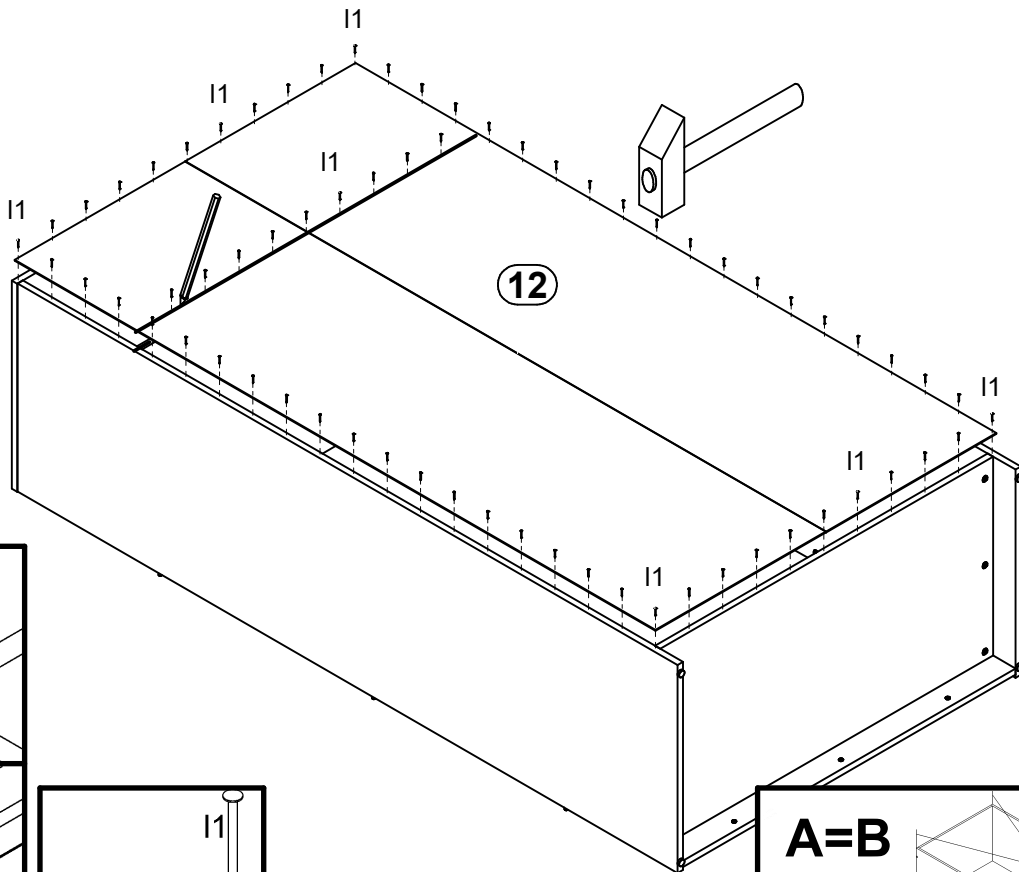

5

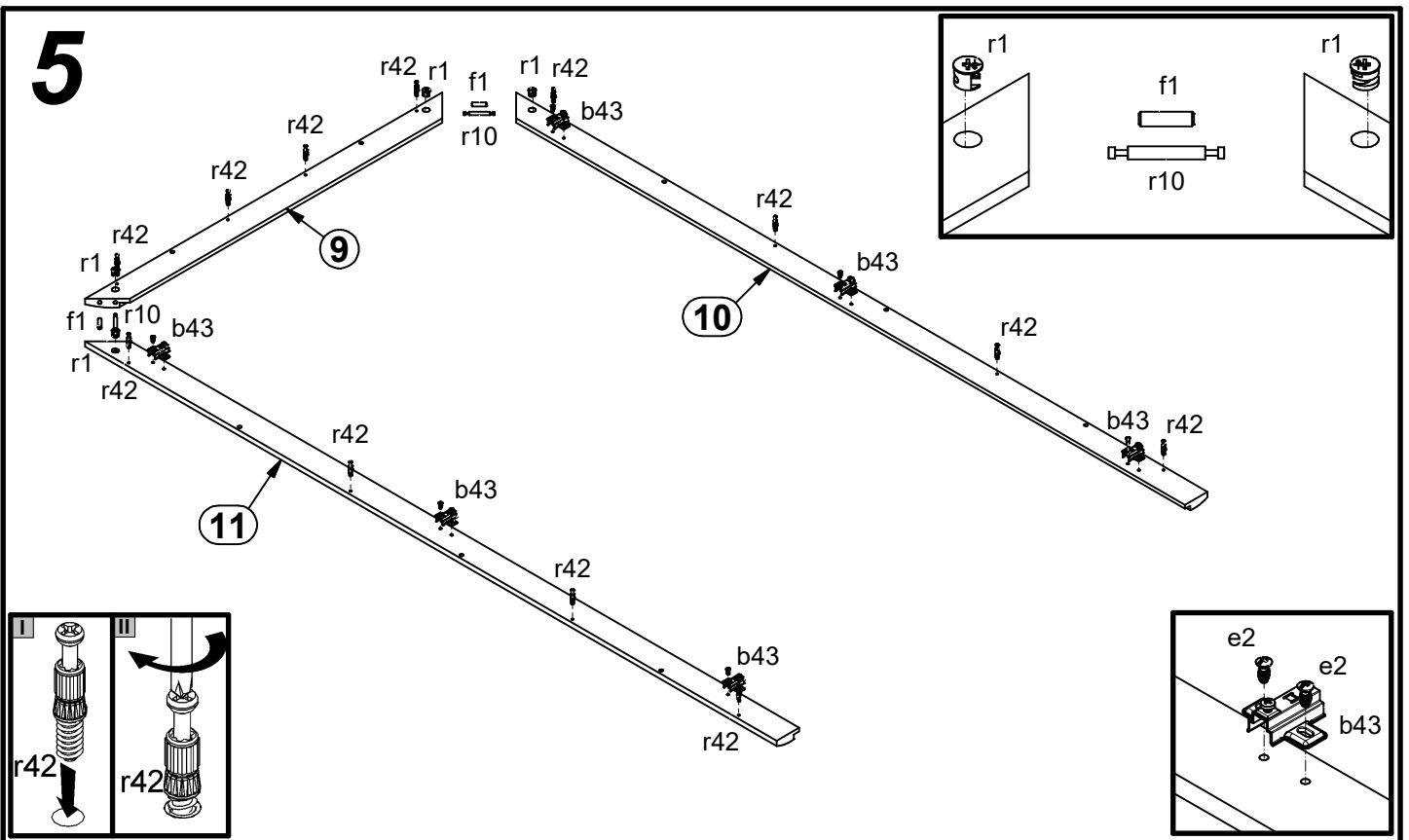

6

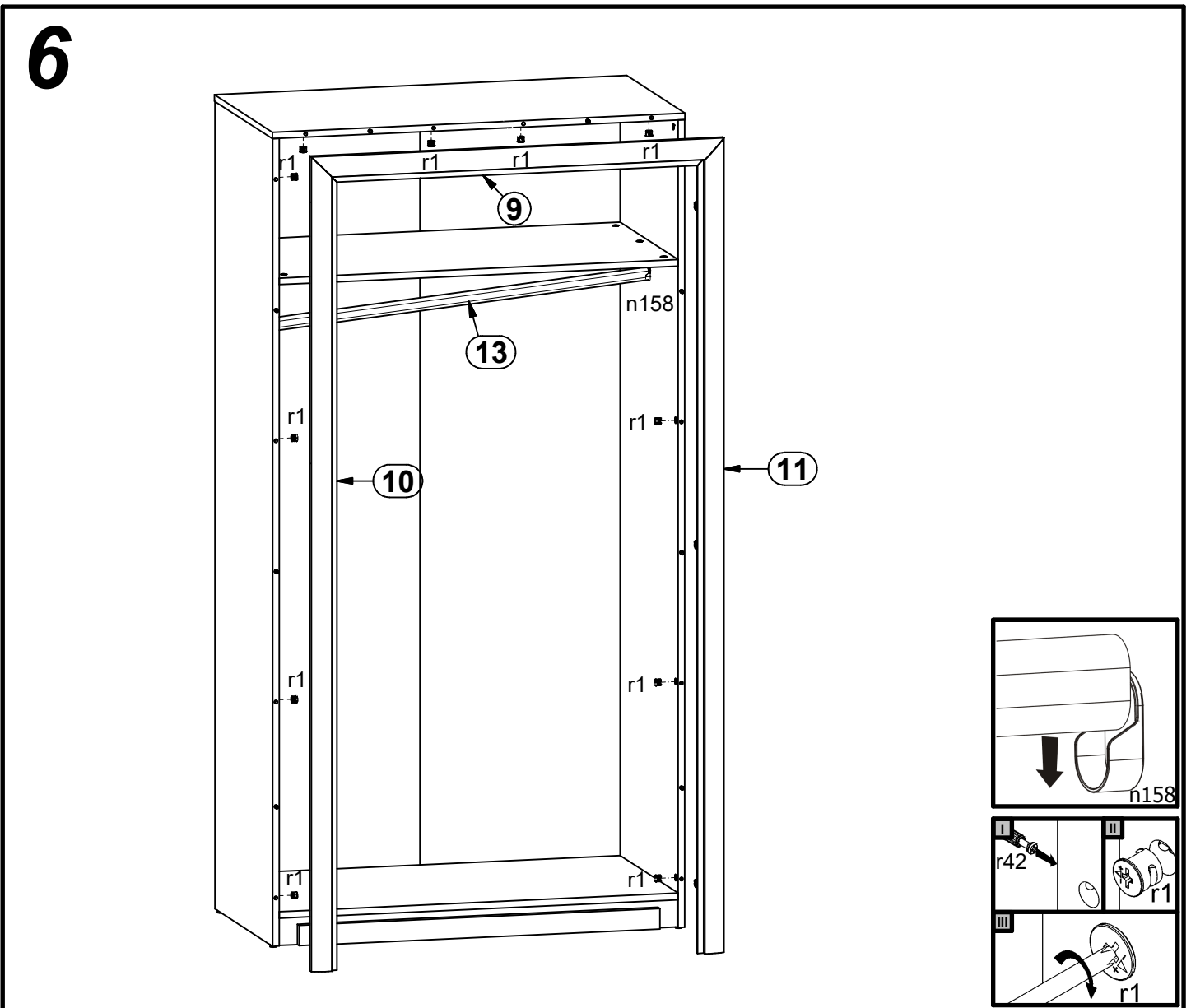

7

