

KASPIAN

S128-REG/90

A	B	C1	C2	C3	D
1	S508-1051	1964	396	36	2/2
2	S508-1052	1964	396	36	2/2
3	S508-2009	900	399	36	1/2
4	S508-3013	862	368	22	1/2
5	S508-3027	863	370	22	1/2
6	S508-4023	863	44	15	1/2
7	S508-9310	1938	893	2,5	2/2

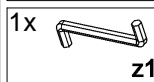
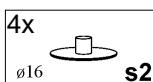
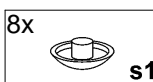
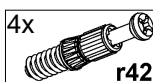
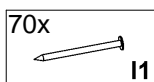
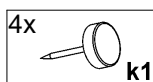
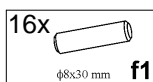
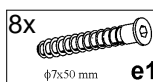
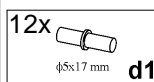
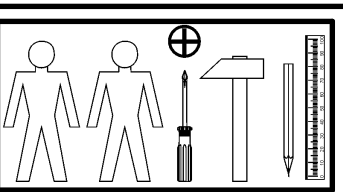
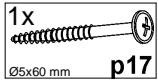
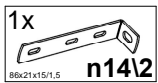
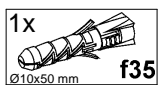
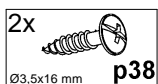
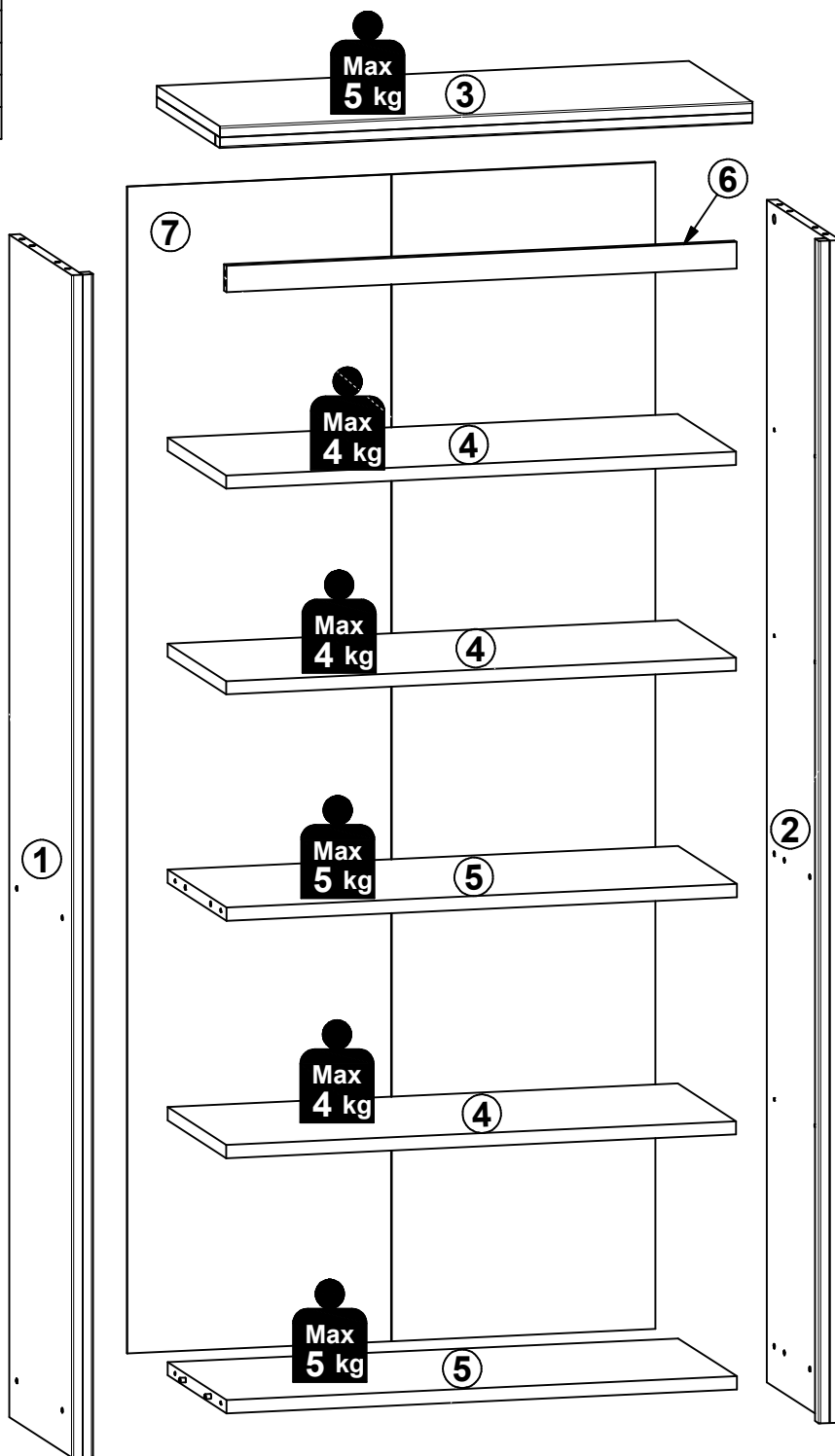
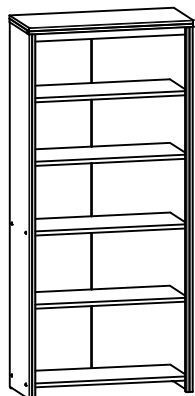

1

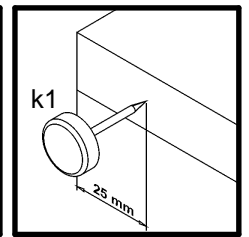
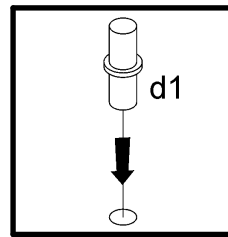
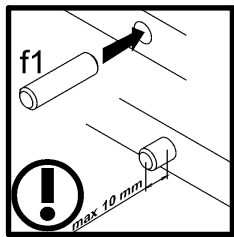
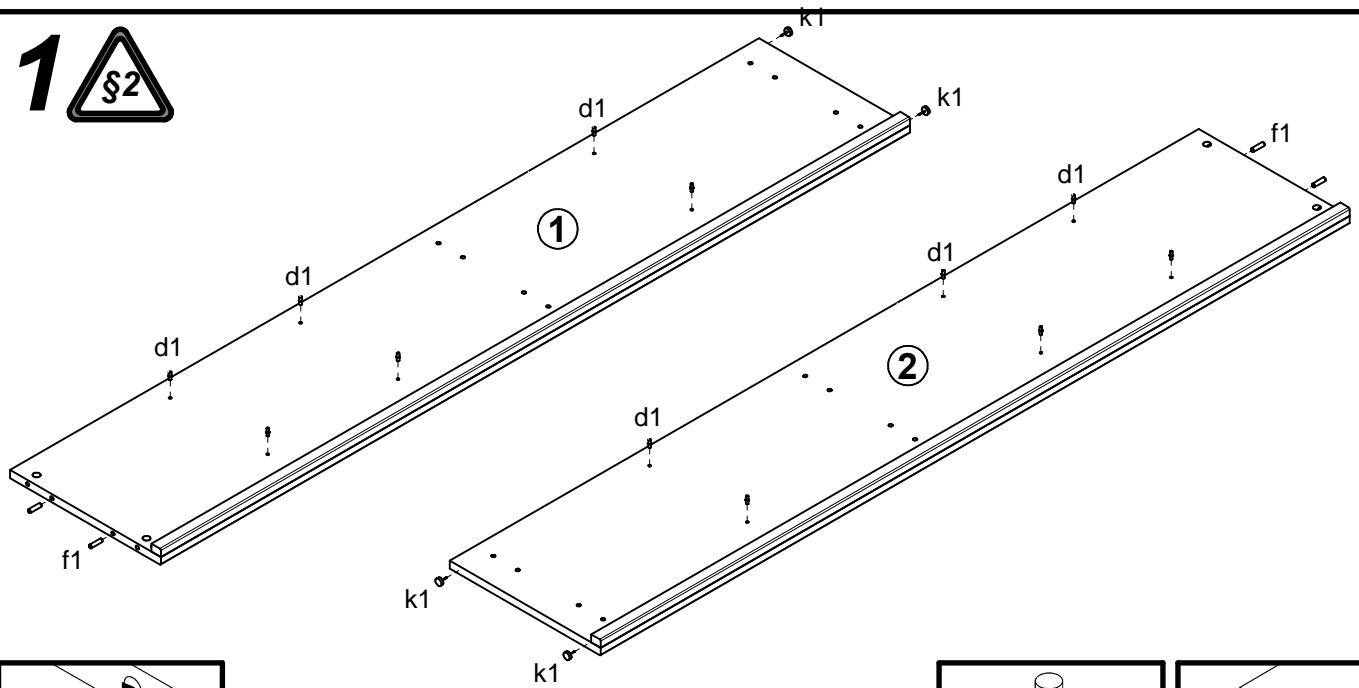

2

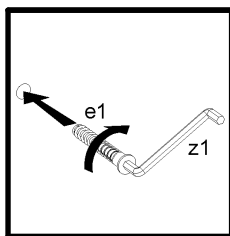
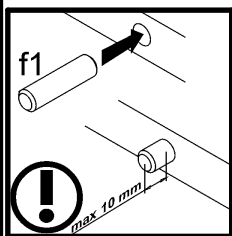
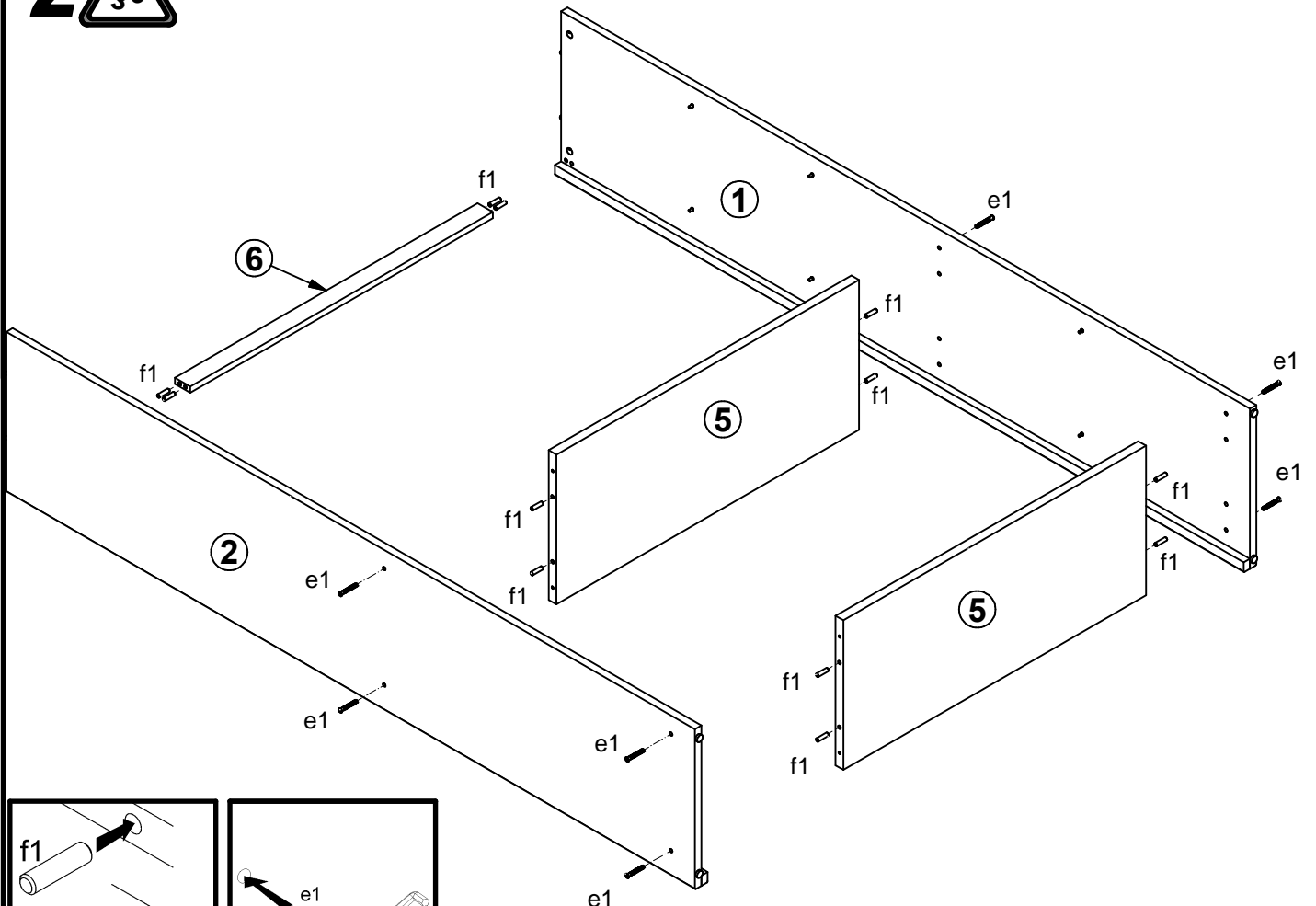

3

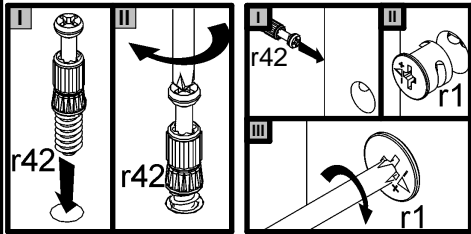
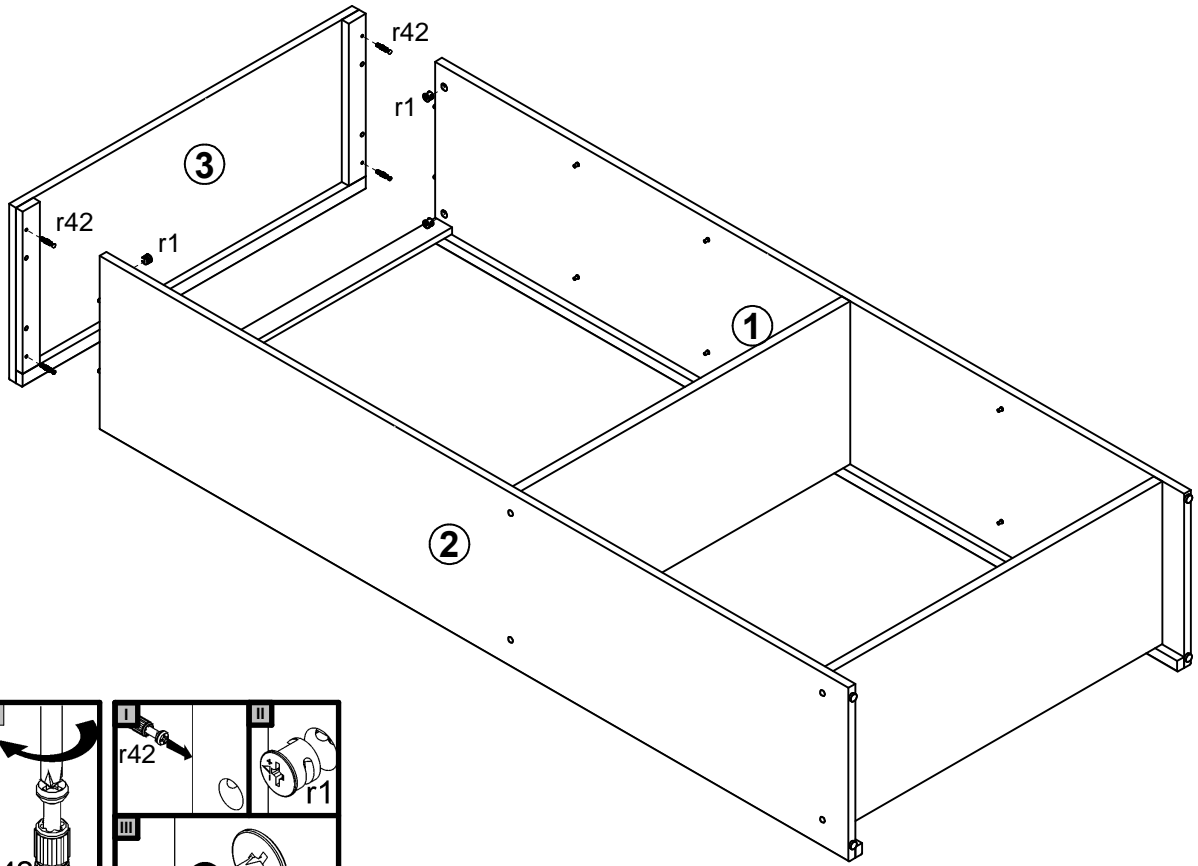

4

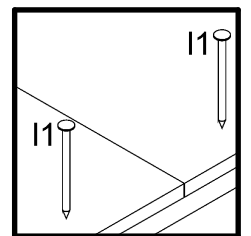
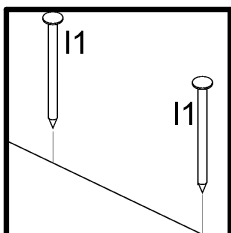
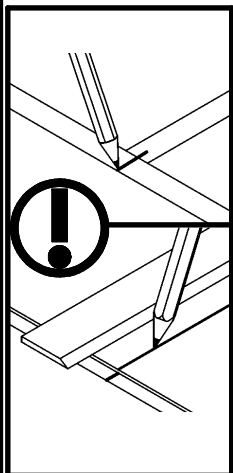
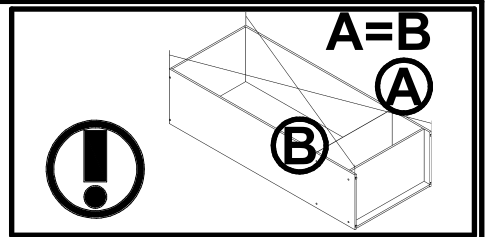
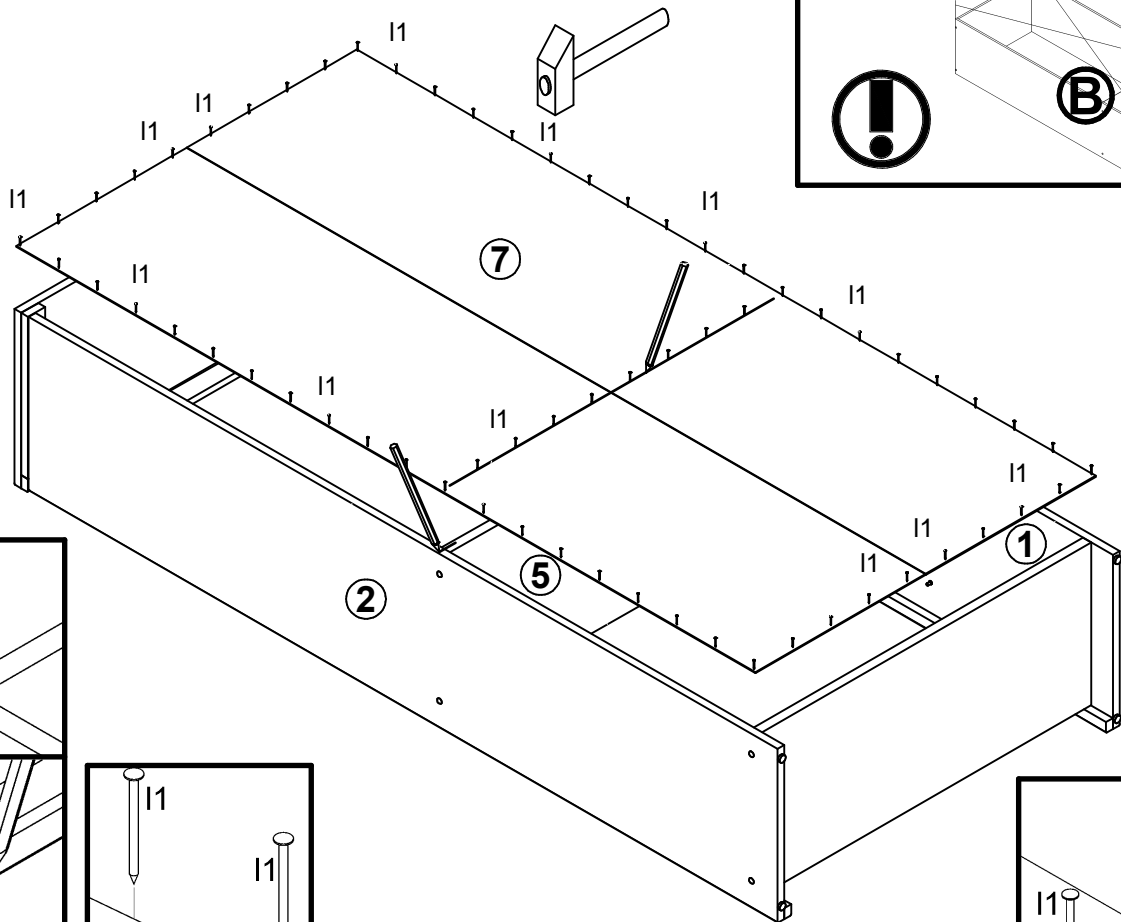

5

