

A	B	C	D
1	L87-4009	2012	170 3/3
2	L87-4010	2012	170 3/3
3	L87-4012	1692	452 2/3
4	L87-4013	1692	802 1/3
5	ZZ1-431	64	70 3/3
6	ZZ1-458	266	70 3/3
7	ZZ1-718	1995	70 3/3
8	ZZ1-747	1880	25 3/3

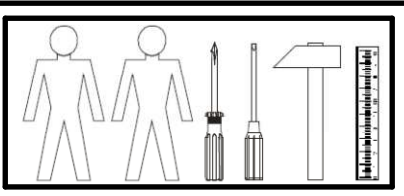

16x Ø6.3x13 mm e2	8x Ø6x13 mm e3	2x Ø7x60 mm e8	12x Ø8x30 mm f1	4x Ø8x50 mm f6	4x M6x65 mm j132	6x k1	2x n3411	2x n3412
2x 130x34x34/2 mm n63	6x Ø4x35 mm p6	12x Ø4x40 mm p10	6x Ø3.5x25 mm p16	4x Ø10x16 mm r43	1x 4 mm z1			

1 A

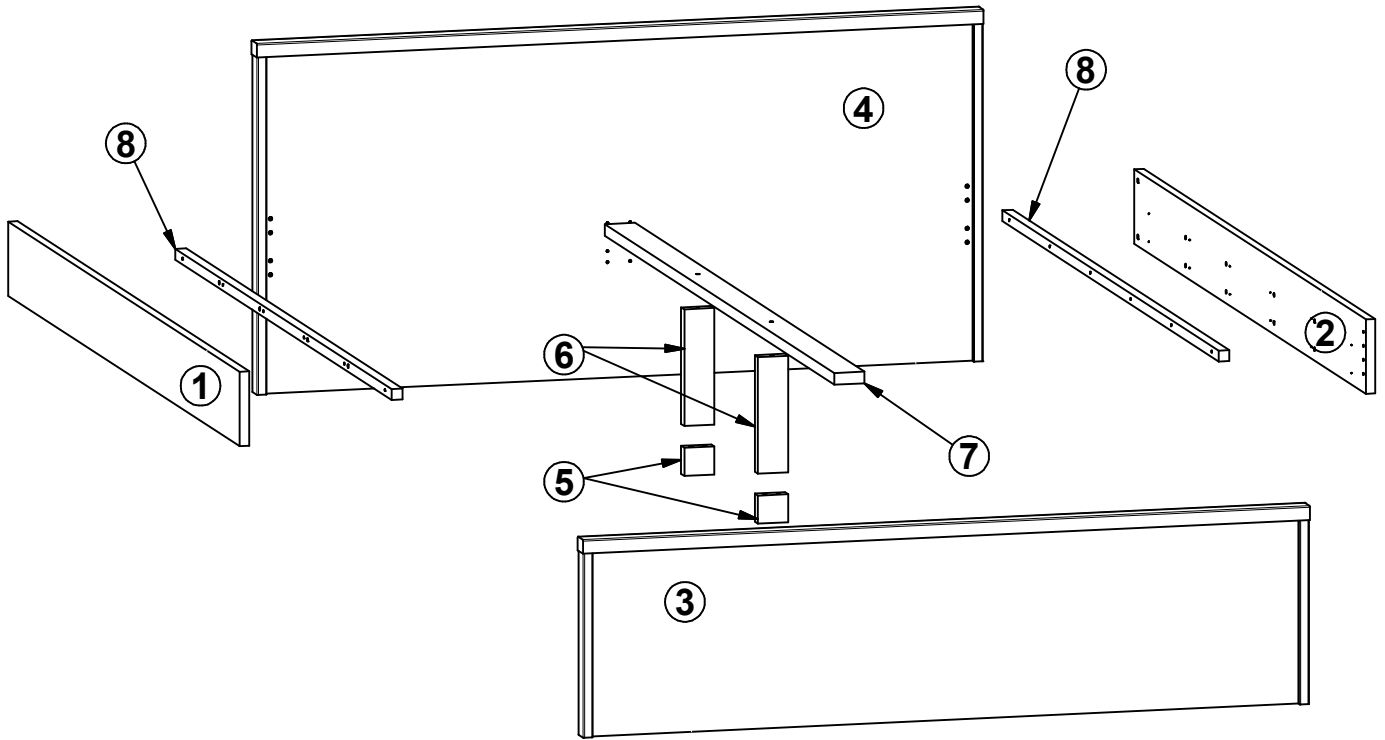
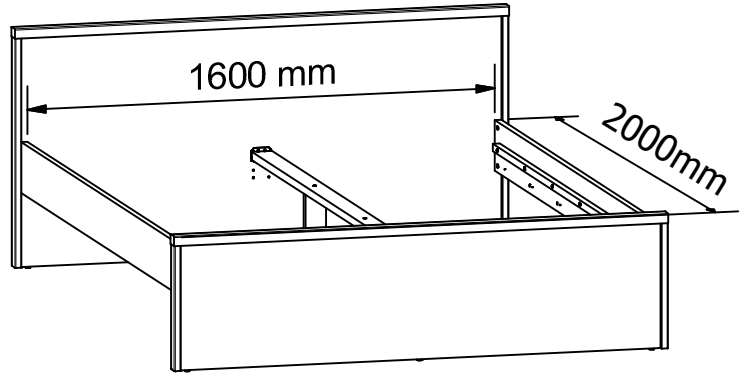
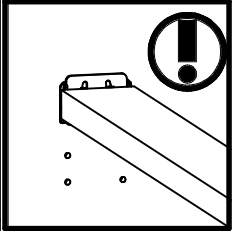
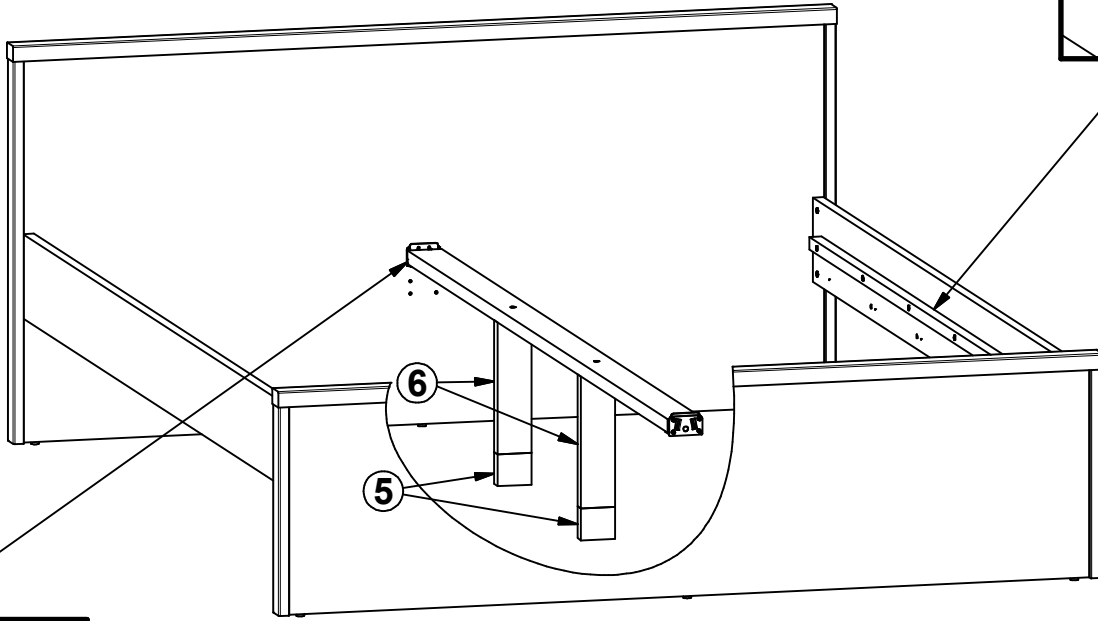
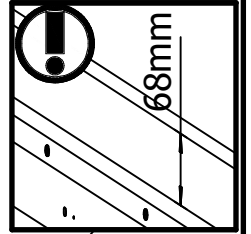

1 B

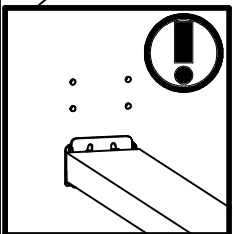
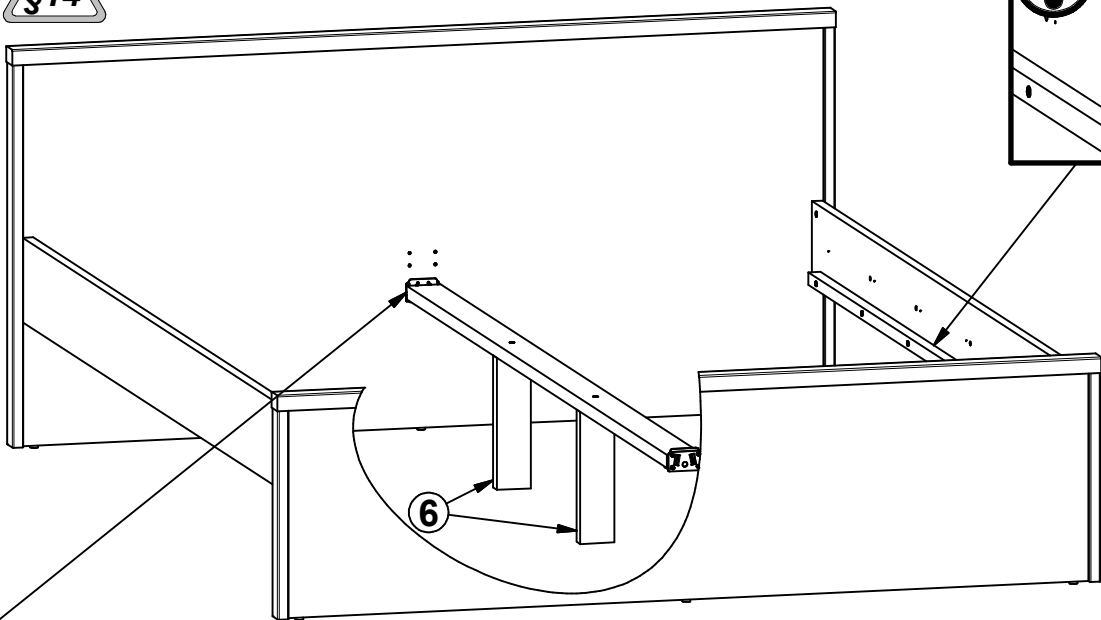
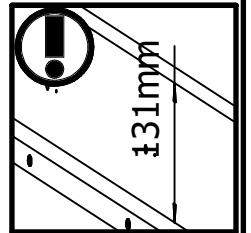

2 

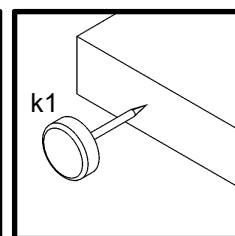
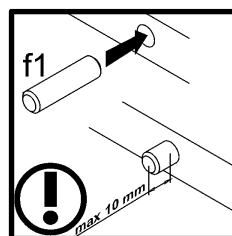
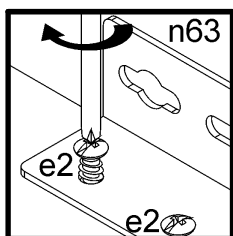
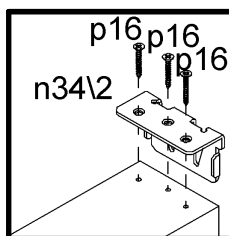
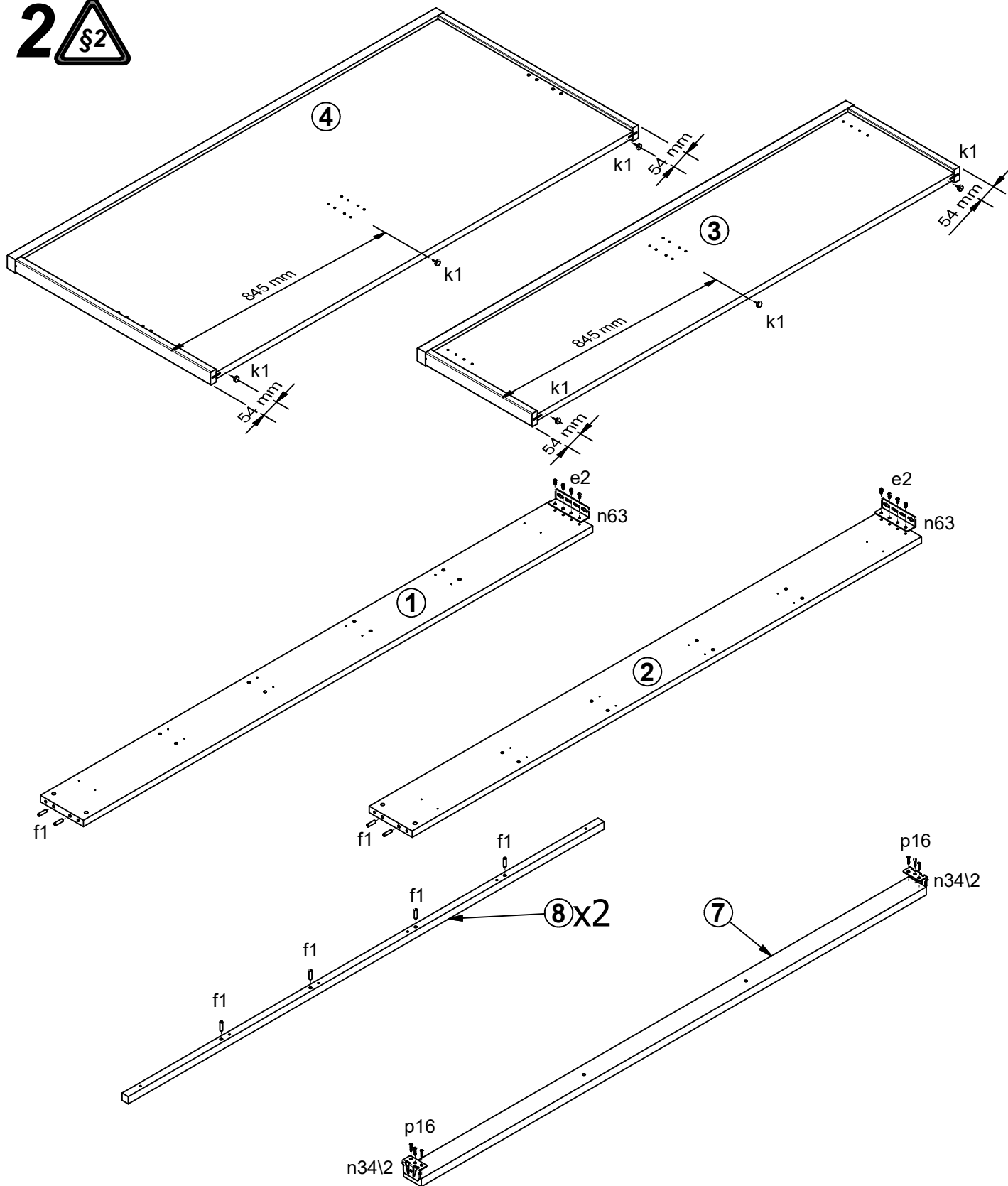

3  

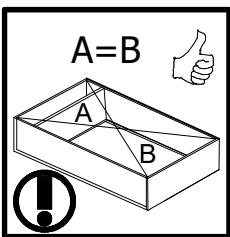
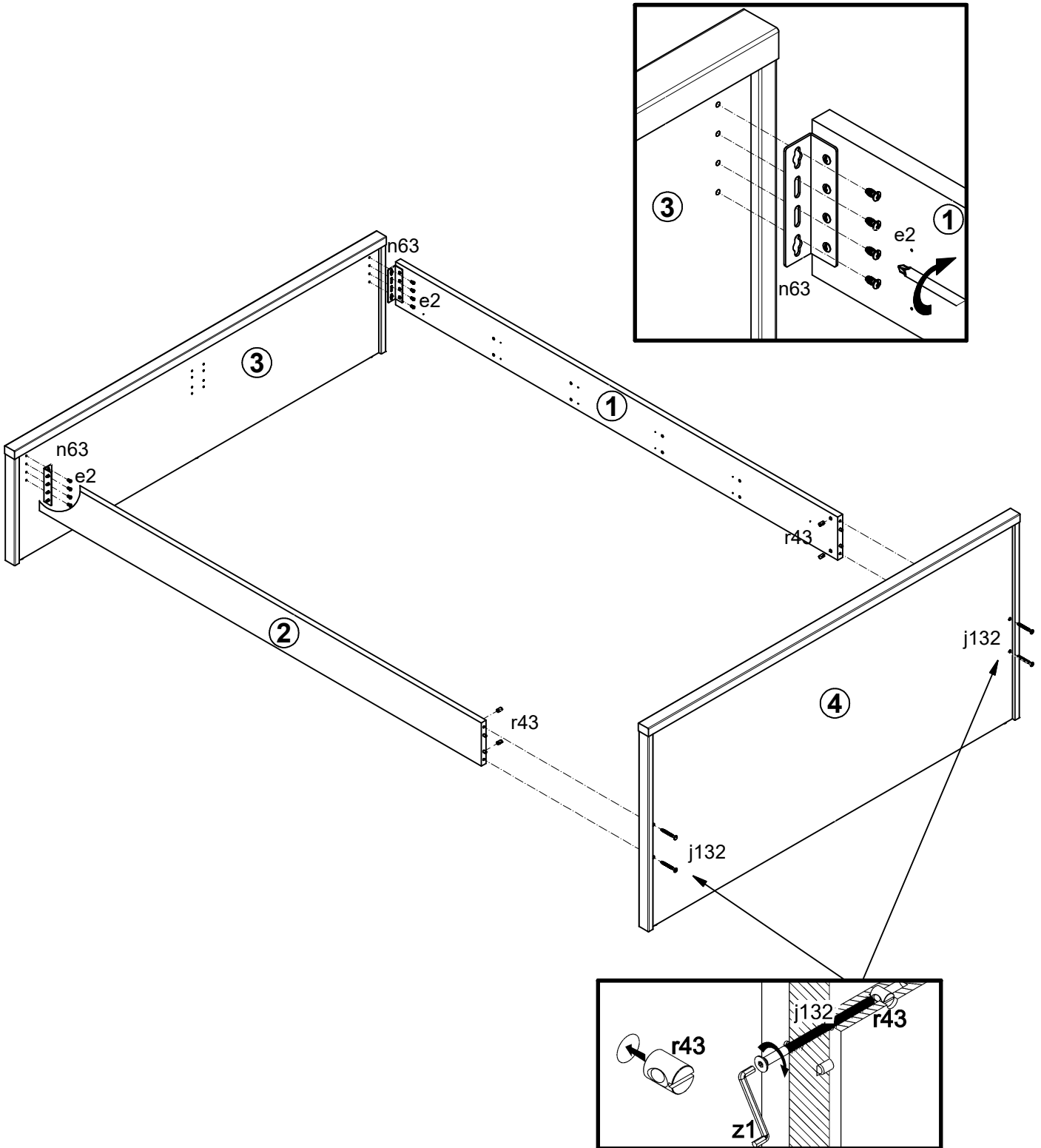

4 A

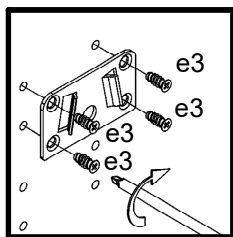
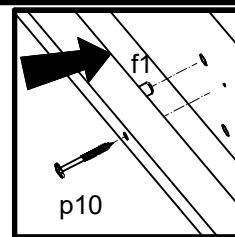
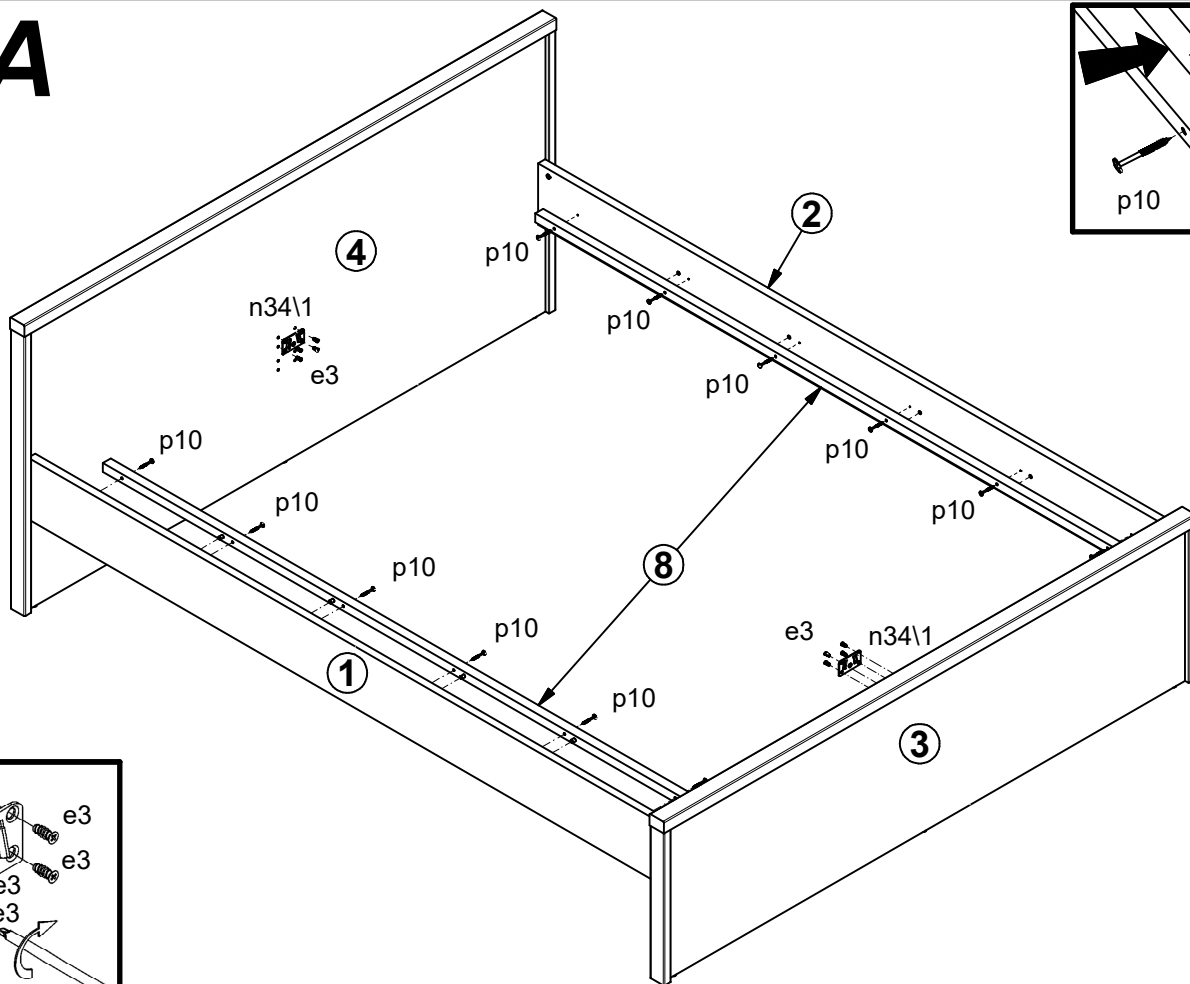

4 B

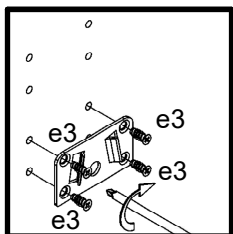
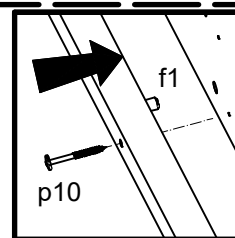
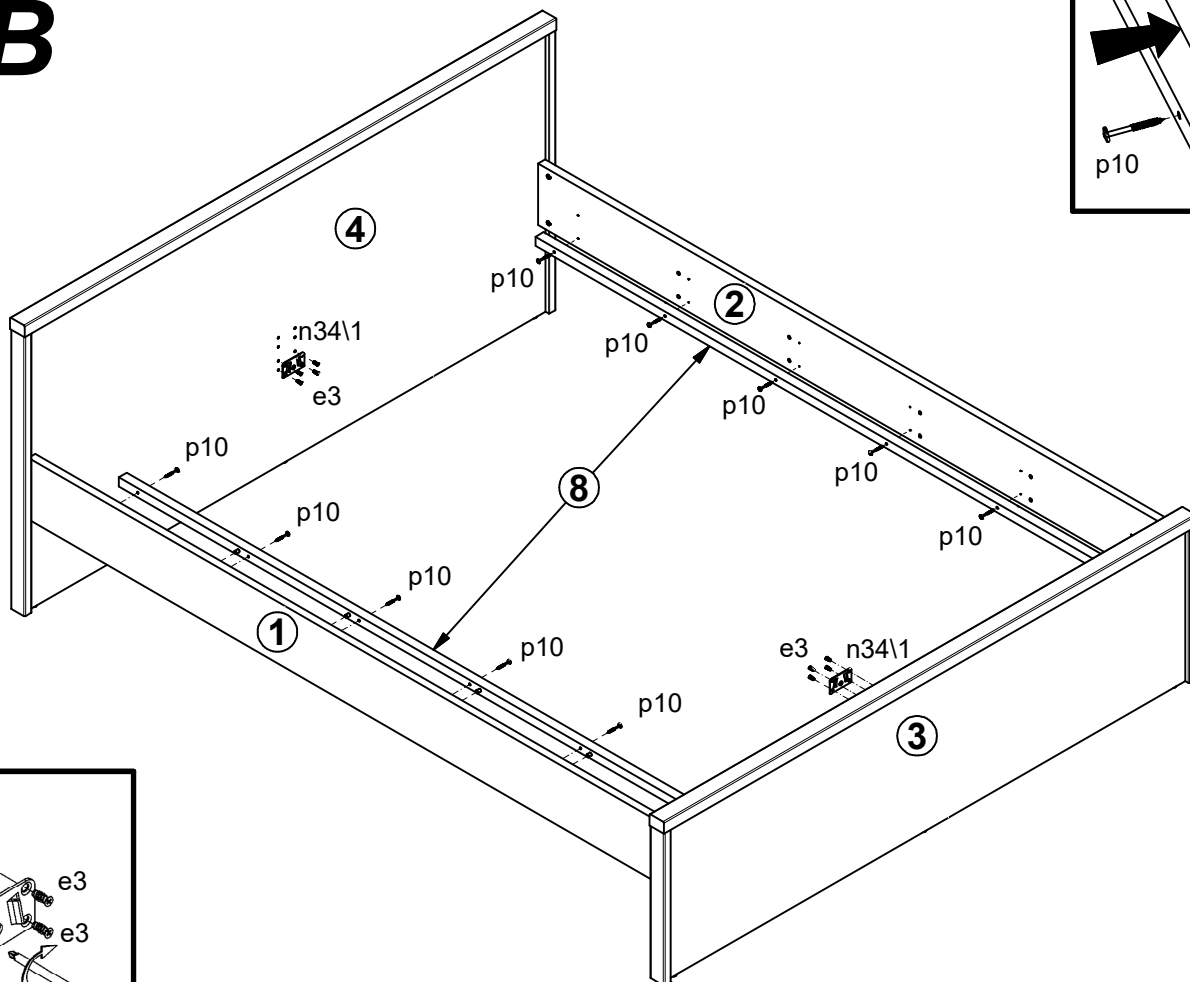

5 A

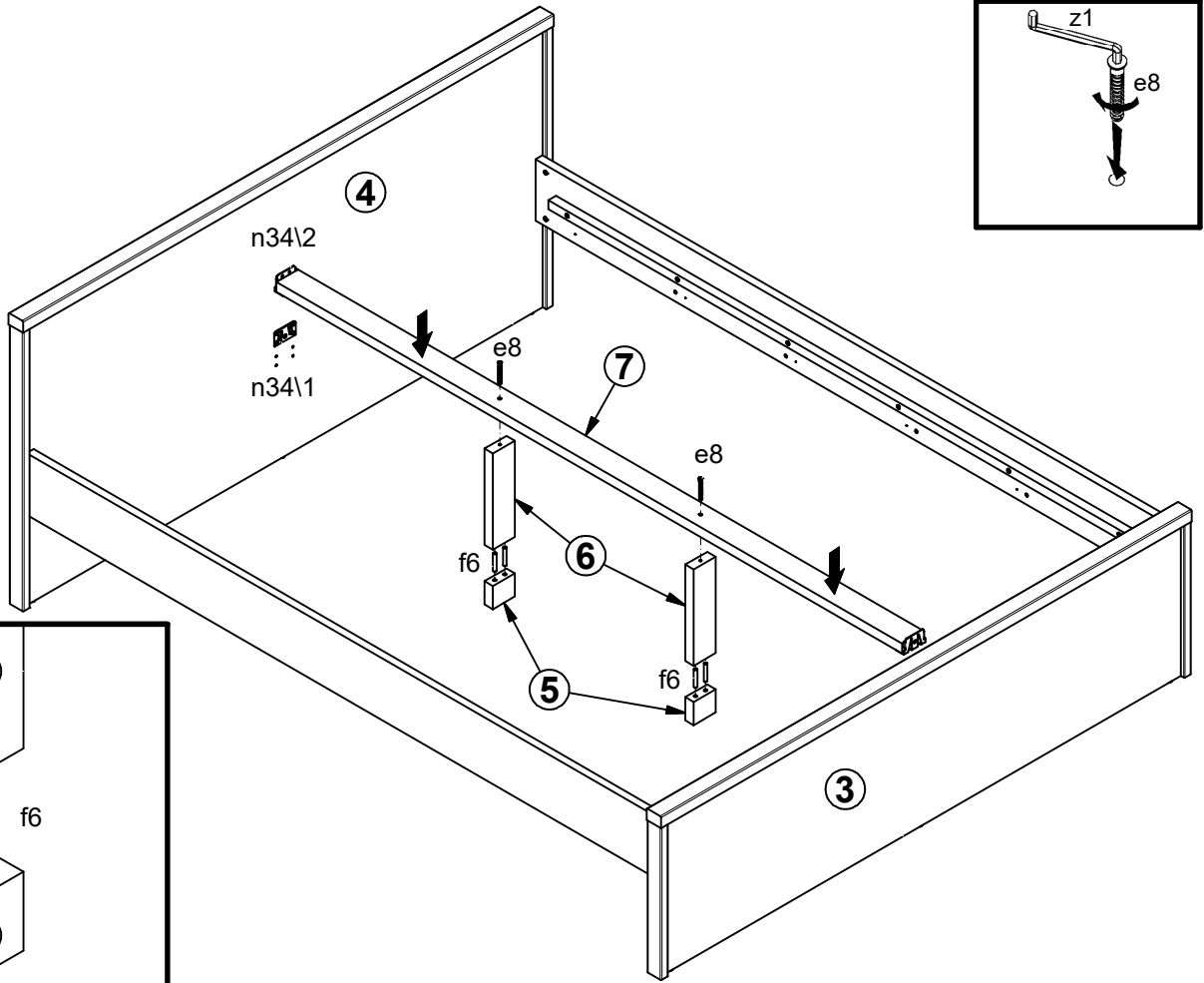
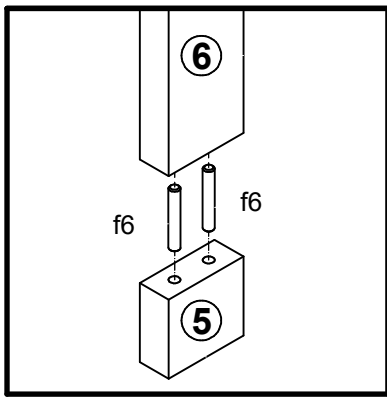

5 B

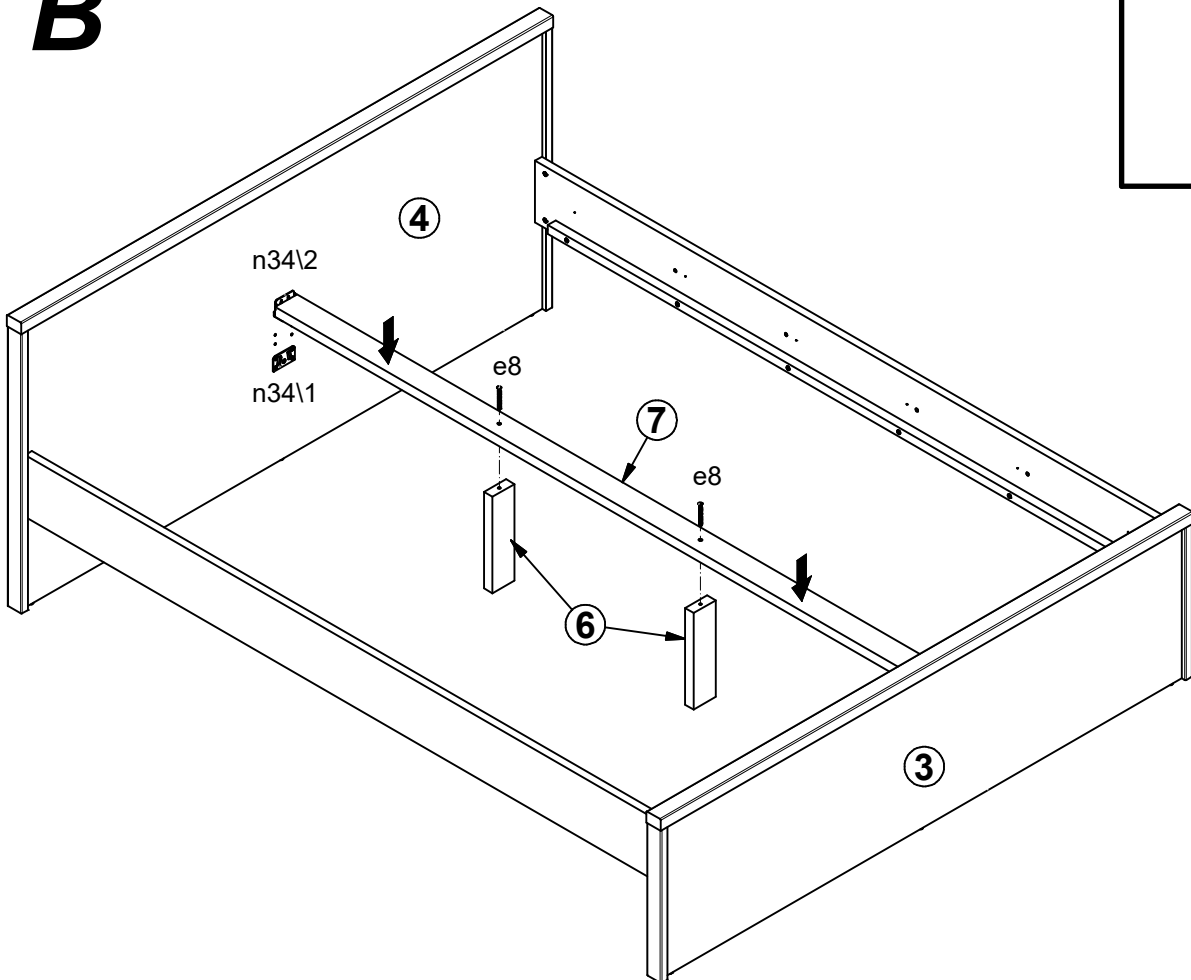
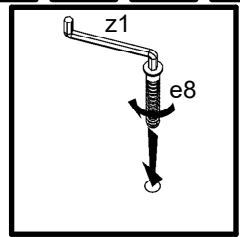

6

