

A

BAYLAR

S415-REG1W1D/68

A	B	C	D
1	S415-0007	628	514
2	S415-0008	514	150
3	S415-0009	514	150
4	S415-1009	1944	371
5	S415-1010	1944	371
6	S415-2003	679	371
7	S415-3007	648	371
8	S415-3008	647	366
9	S415-5011	680	80
10	S415-5012	1880	80
11	S415-5013	1880	80
12	S415-5014	519	32
13	S415-5015	648	75
14	S415-5016	850	512
15	S415-5018	646	360
16	S415-5019	519	32
17	S415-9305	1940	673

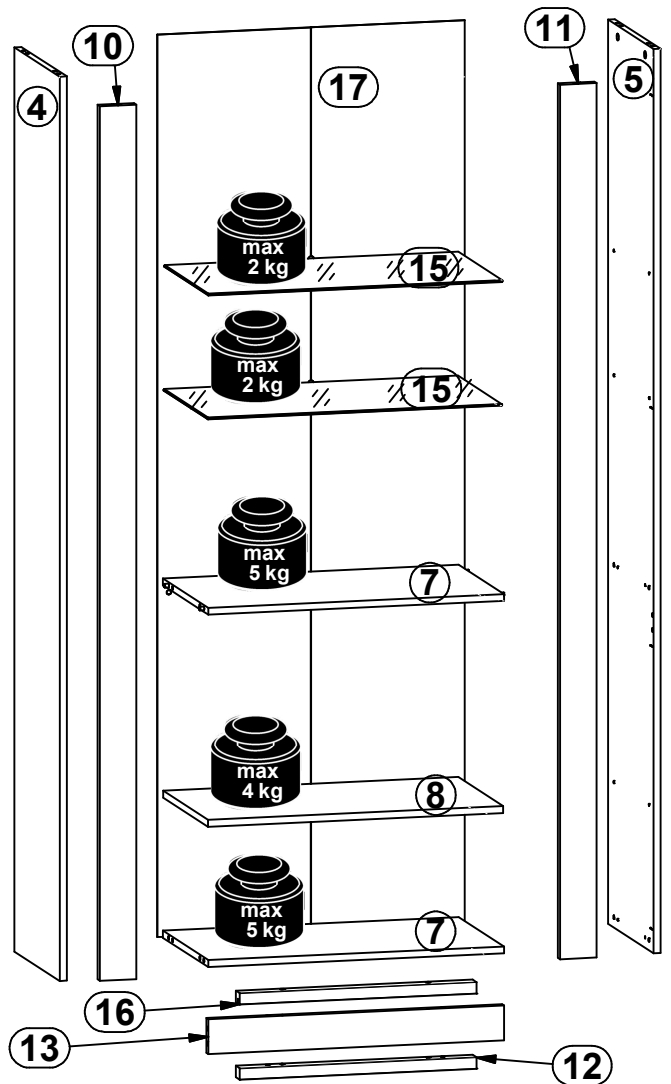
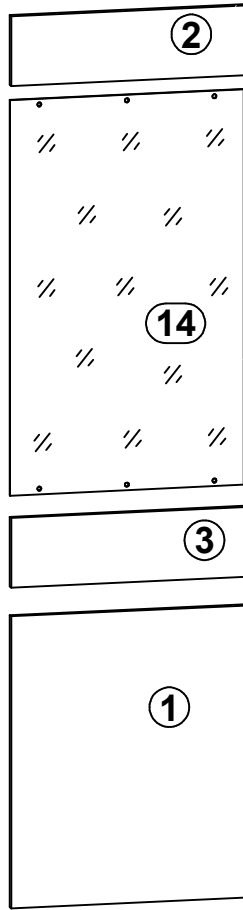
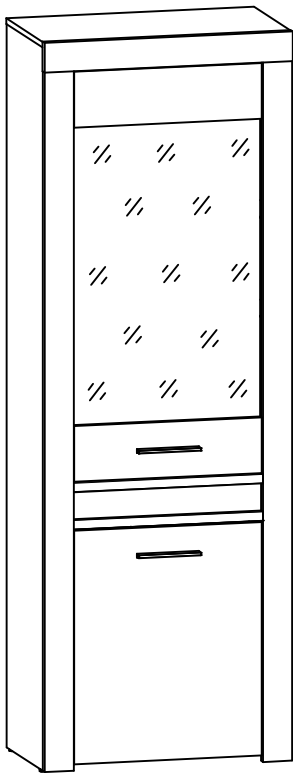
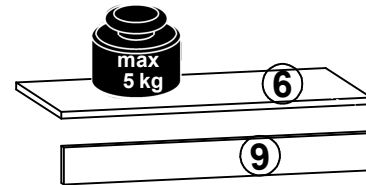
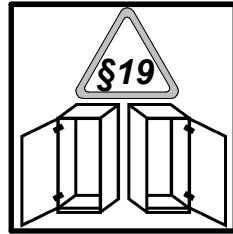
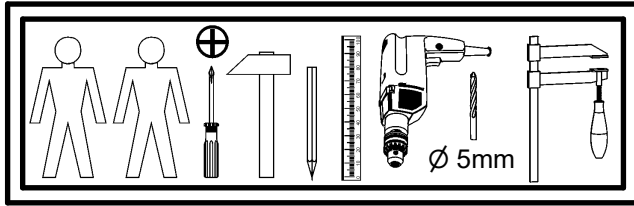

4x a132	2x a133	4x b43	2x c36517 L=170	4x d1 Ø5x17 mm	8x d3 Ø5x17 mm	10x d37	4x e1 Ø7x50 mm	8x e2 Ø6.3x13 mm
6x e47 Ø5x16 mm	24x f1 Ø8x30 mm	4x k1	50x l1 1.4x20 mm	2x o4318	6x o54 Ø5.3/Ø8.3x4.8 mm	1x o70 Zasilacz 6N 12V z okablowaniem 4m, wyłącznik przesył, rozdzielacz 3 punkty	1x o8314 10x18 mm	1x o10211 L=500 mm
42x p38 Ø3.5x16 mm	8x p51 Ø3.5x15 mm	4x p60 Ø4x22 mm	12x r1 Ø15x12 mm #16	12x r42 20/11	2x s1	4x s2 Ø16	1x z1 4 mm	1x n1412 86x21x151.5
1x n114	1x s50 Ø12.7x3.5 mm silikon	1x p17 Ø5x60 mm	1x f35 Ø10x50 mm	1x p54 Ø3x12 mm				

1 §2

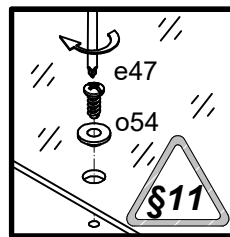
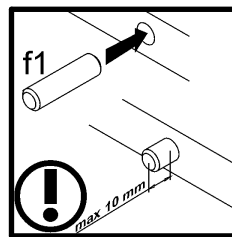
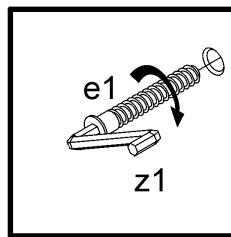
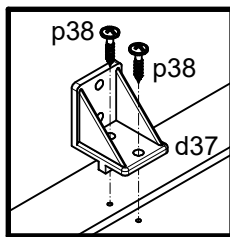
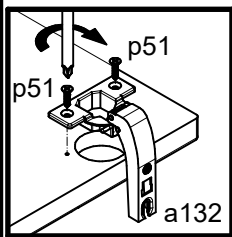
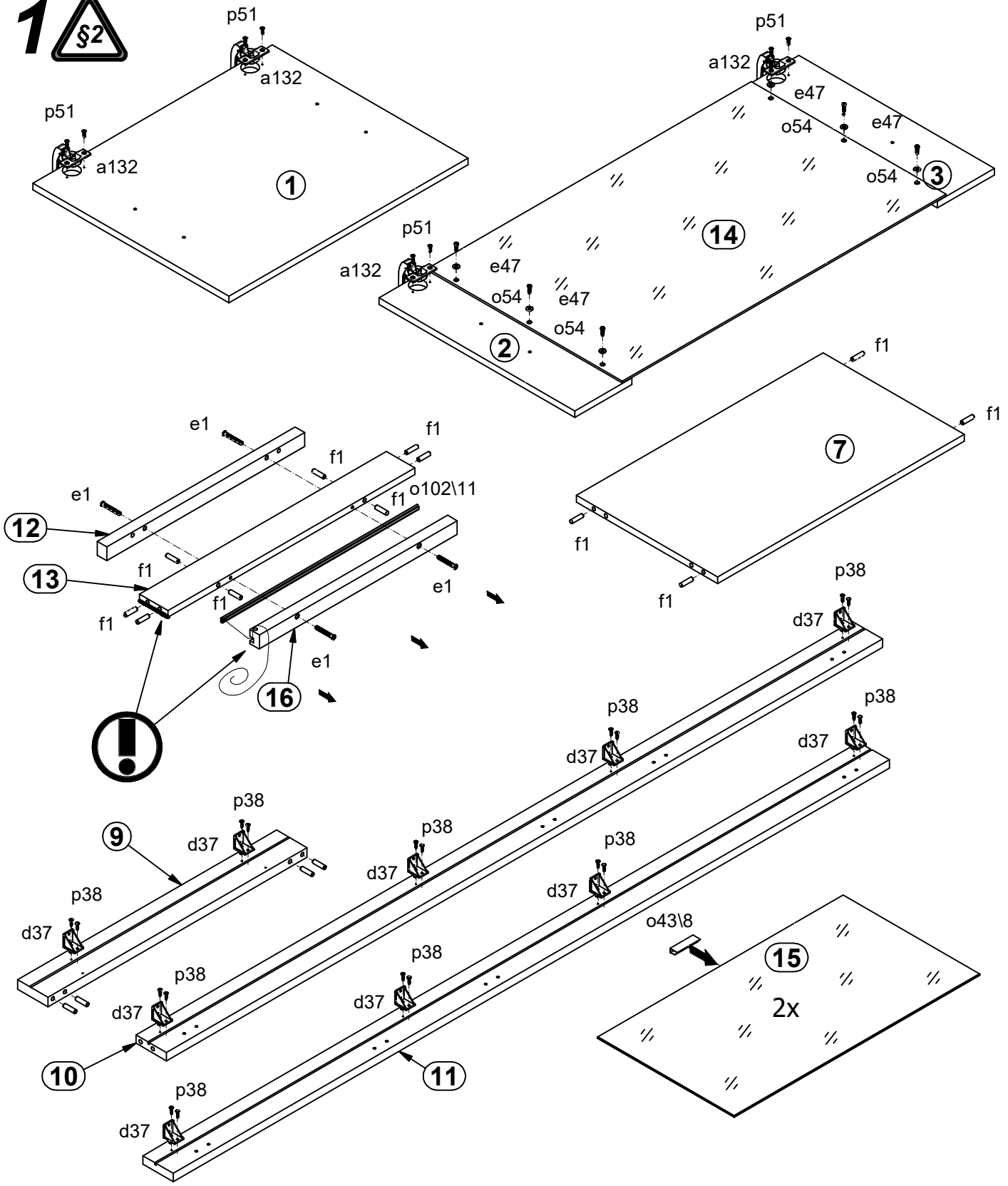

2

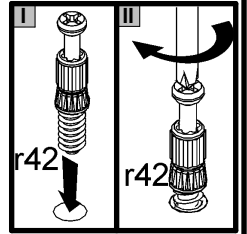
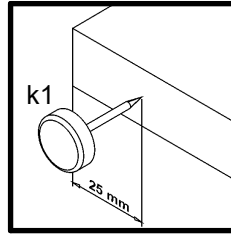
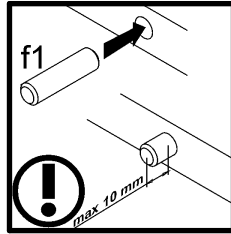
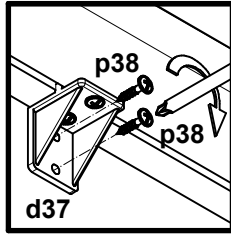
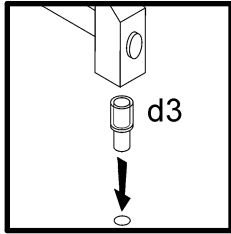
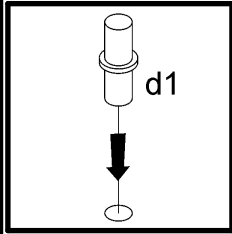
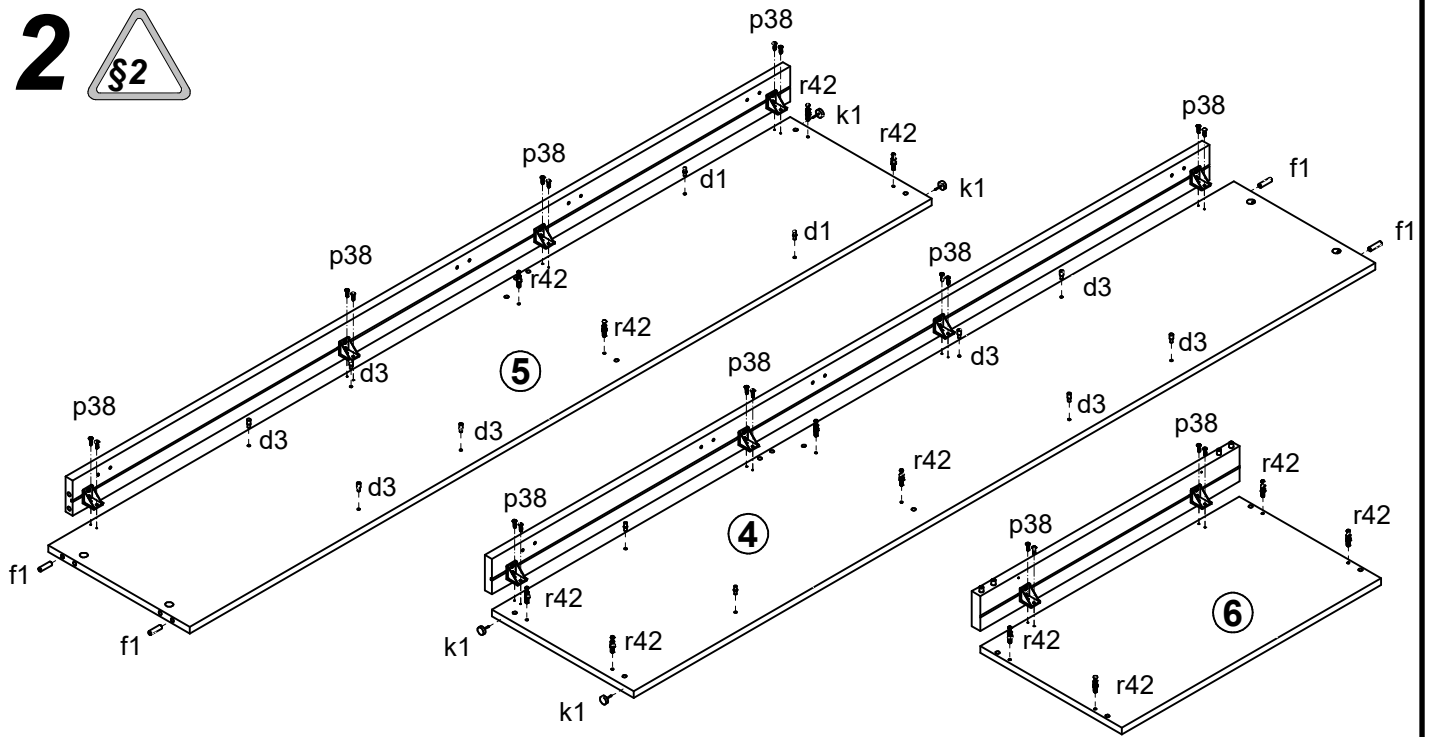

3

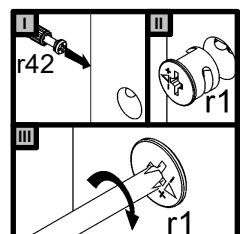
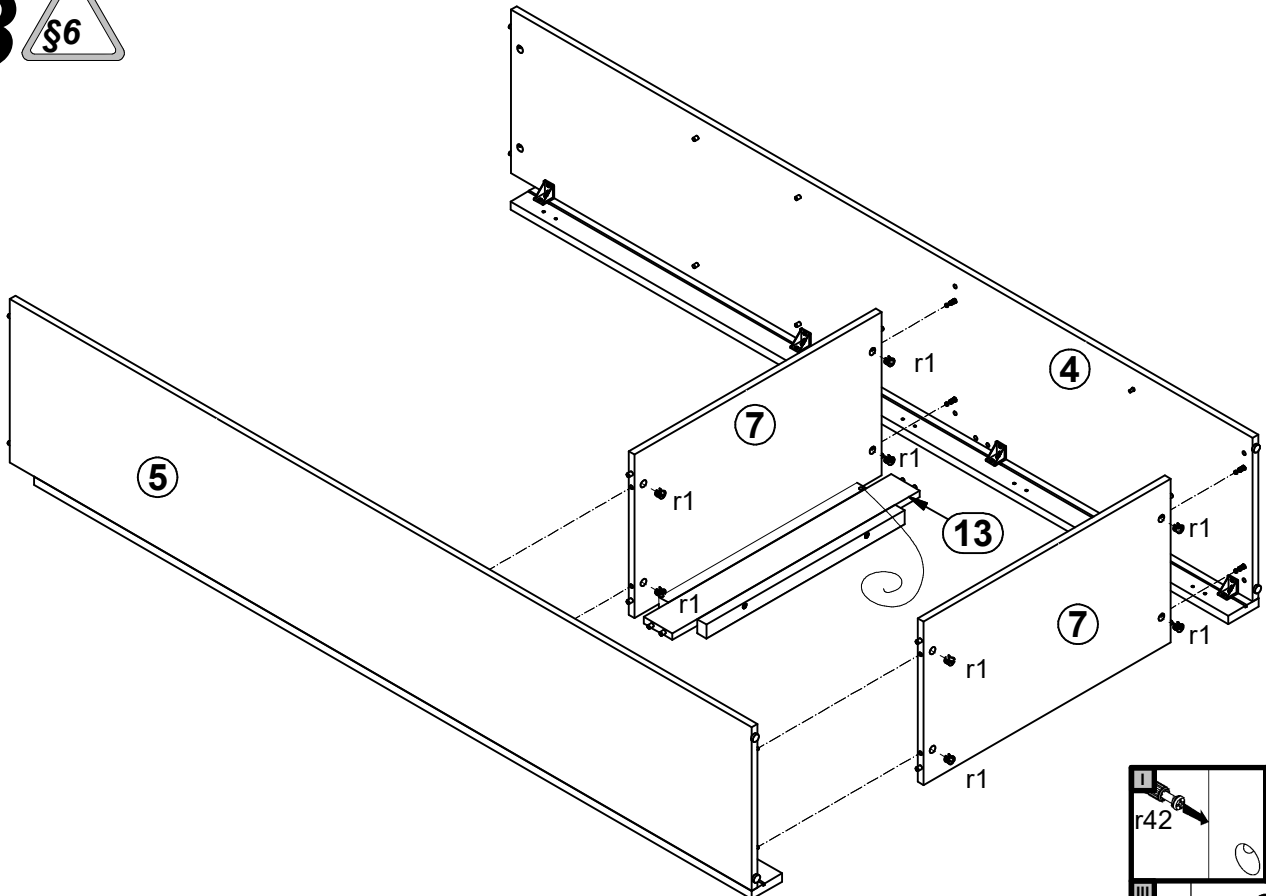

4

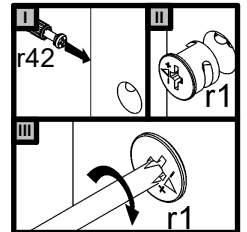
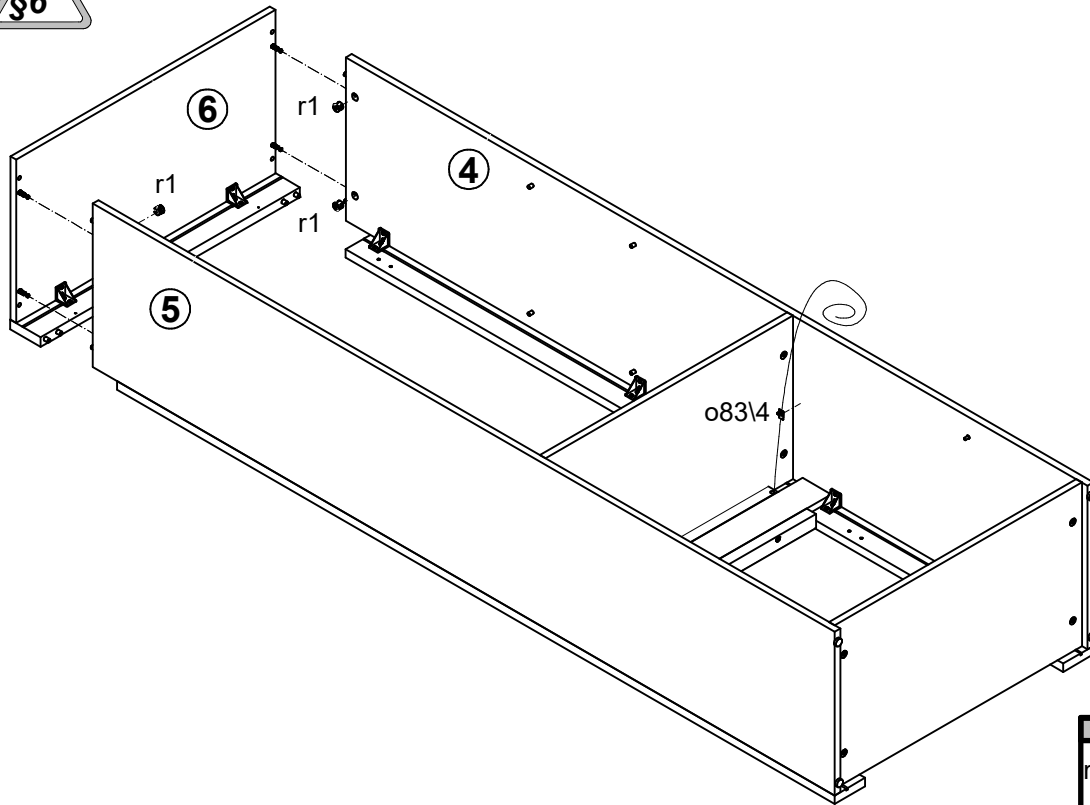

5

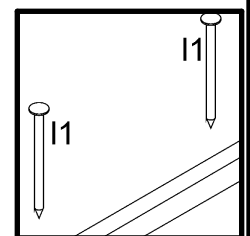
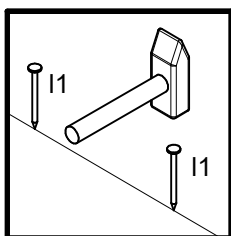
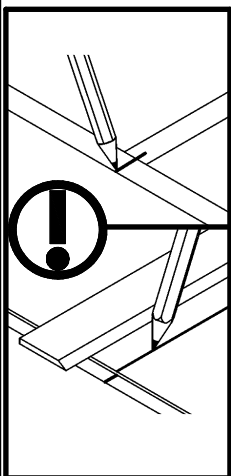
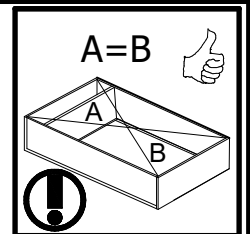
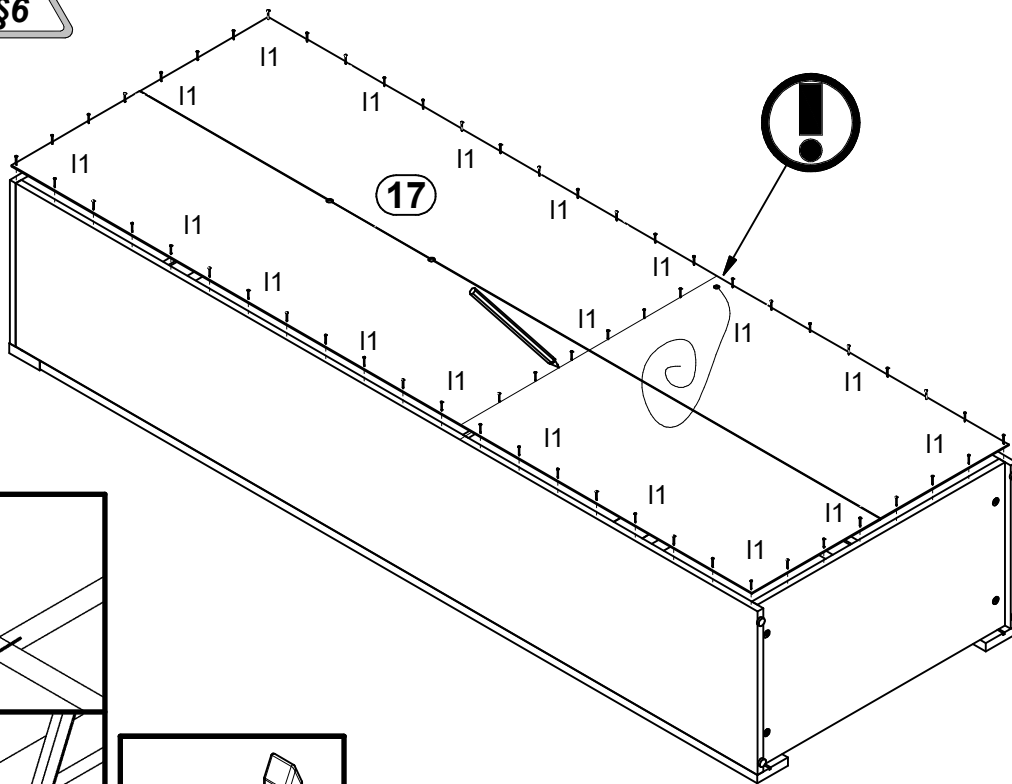

6A



10

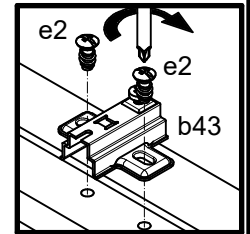
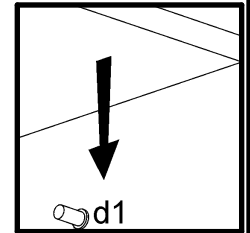
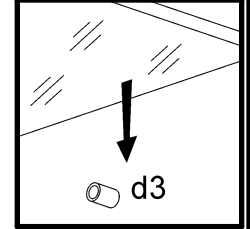
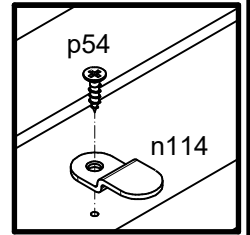
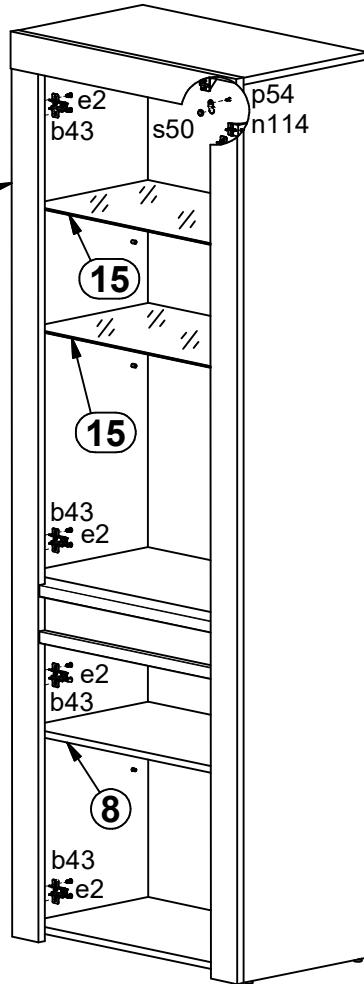

6B



11

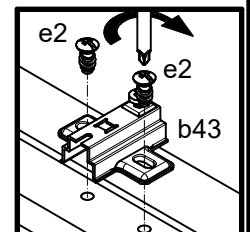
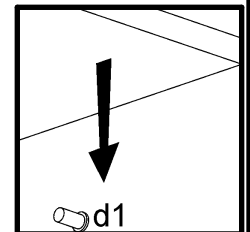
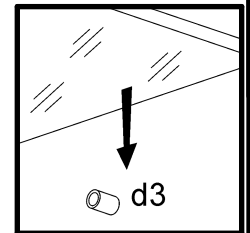
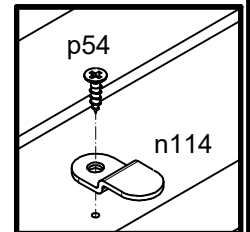
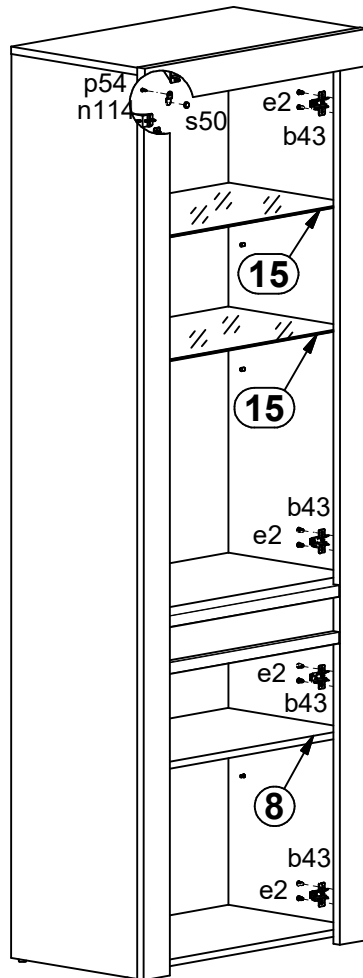

7A

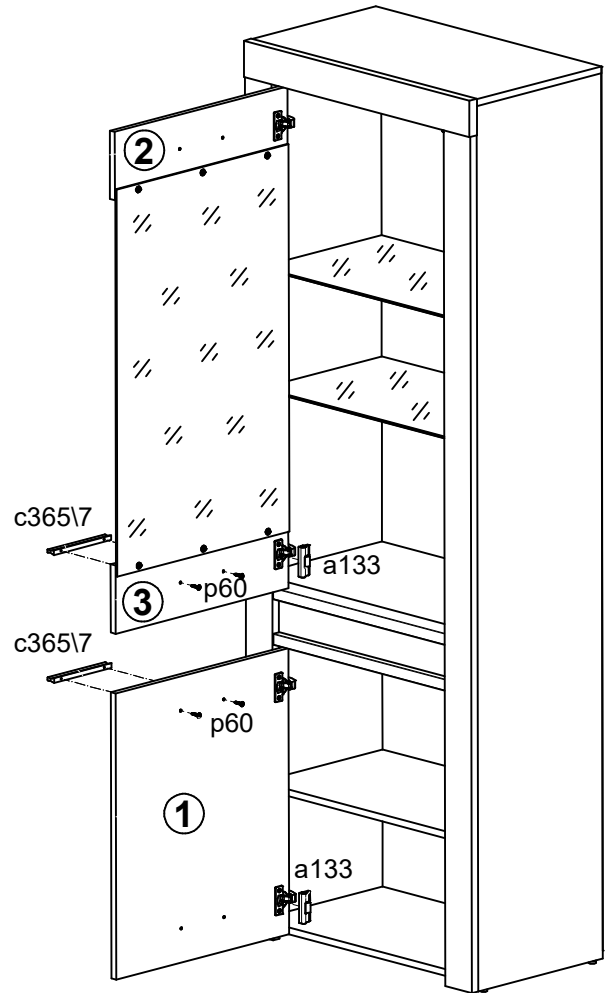
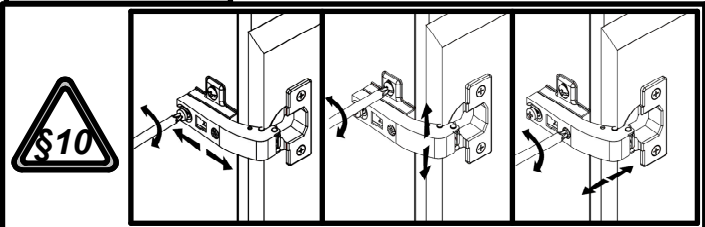
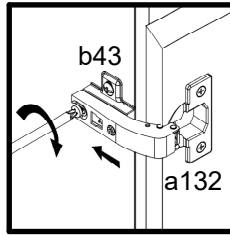
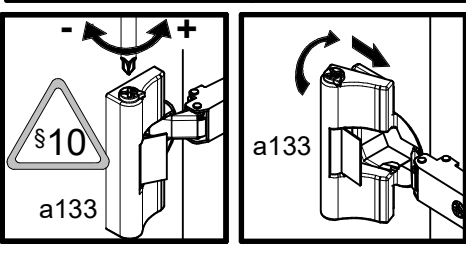
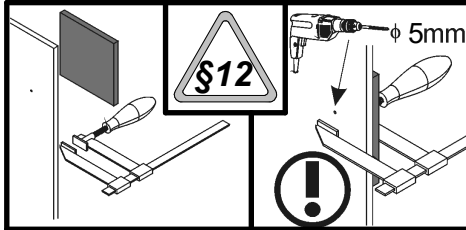
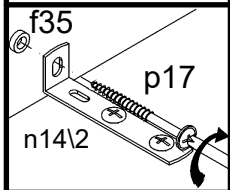
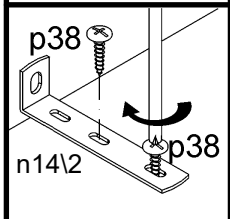
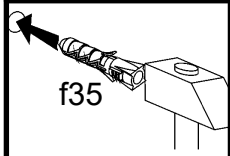
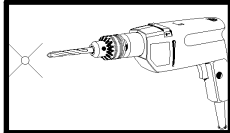

7B

