

A**FLEX****F57-FRN-200/240/LUS-Z**

A	B	C	D	
1	F57-0125	998	577	1/1
2	F57-0126	998	577	1/1



3		998	577	1/1
---	--	-----	-----	-----

4	w108\2	2310	-	1/2
5	Eg-sp_2310	2310	-	2/2

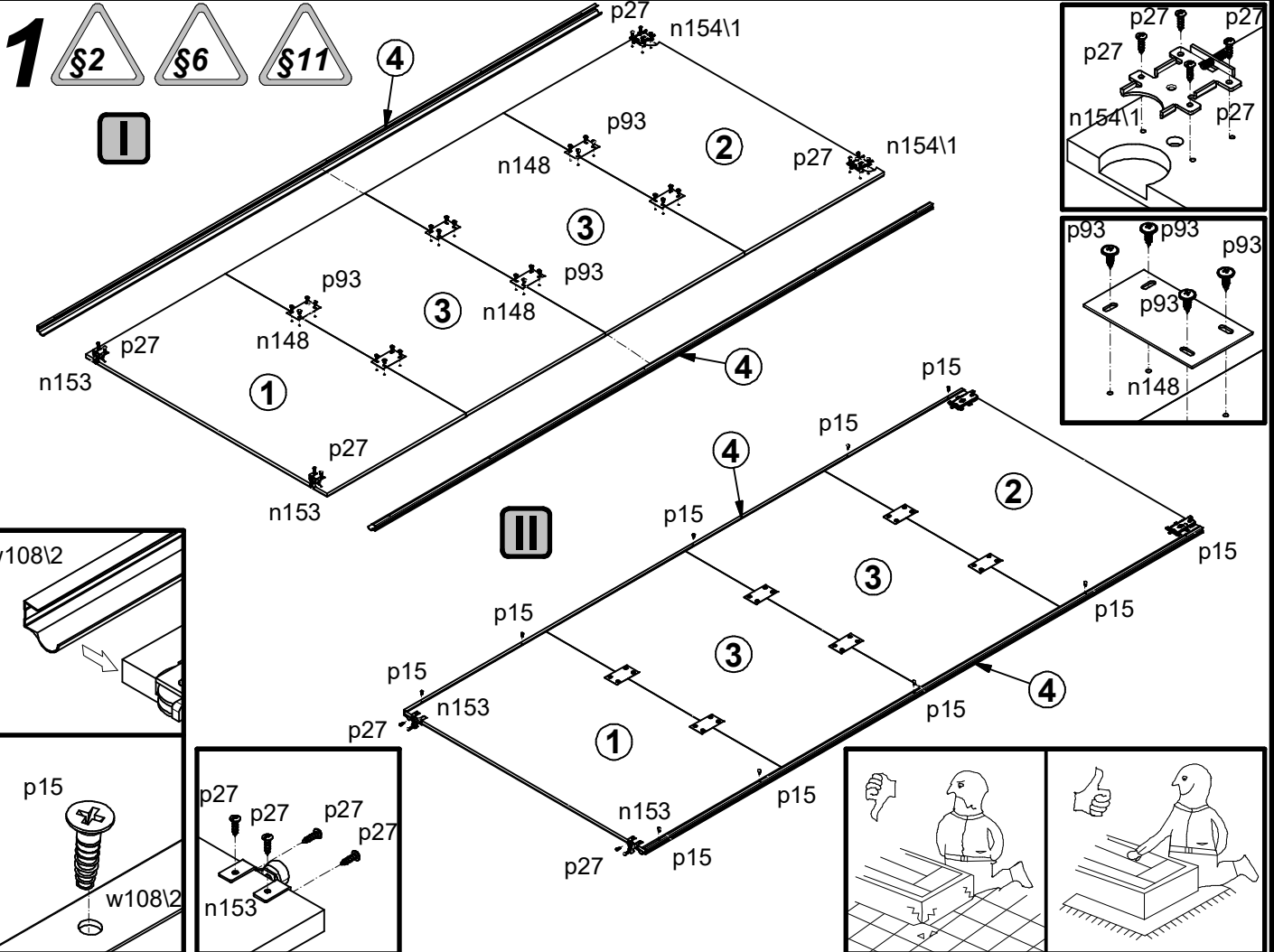
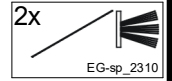
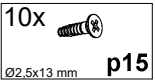
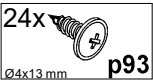
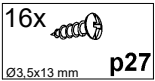
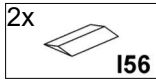
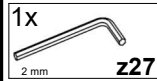
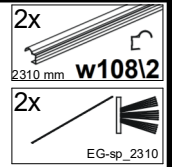
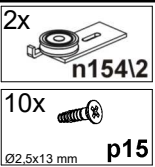
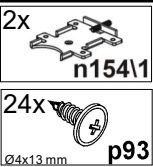
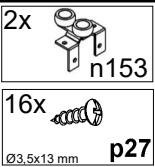
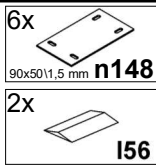
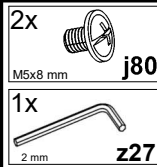
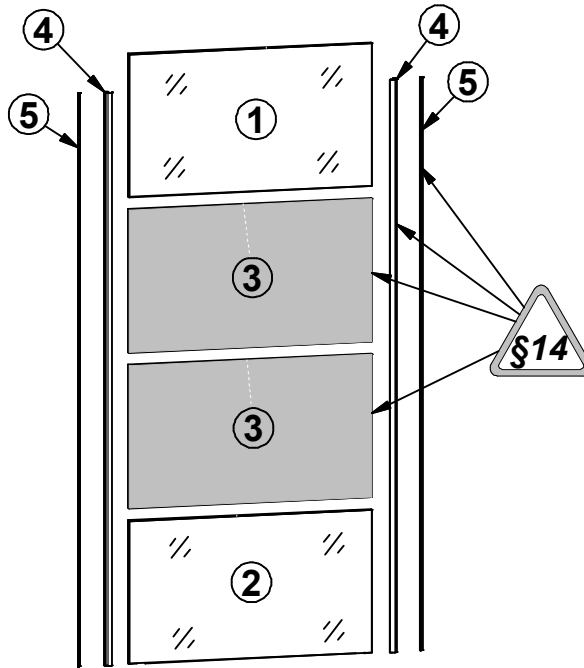
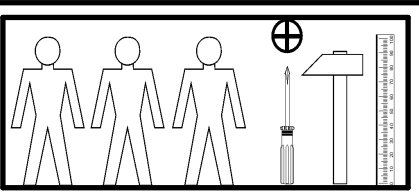

2

