

A

FLEX

F57-FRN-150/218/LUS-Z

A	B	C	D
1	F57-0098	748	696
2	F57-0099	748	696



3		748	696	1/1
---	--	-----	-----	-----

4	w108\3	2090	-	1/2
5	Eg-sp_2090	2090	-	2/2

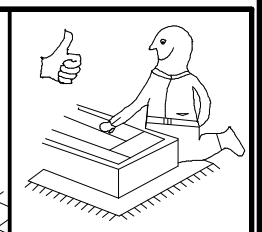
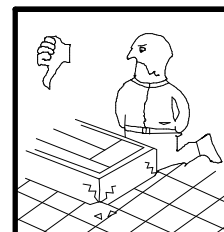
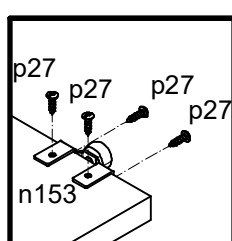
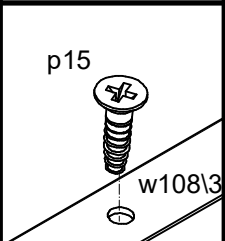
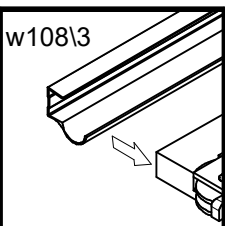
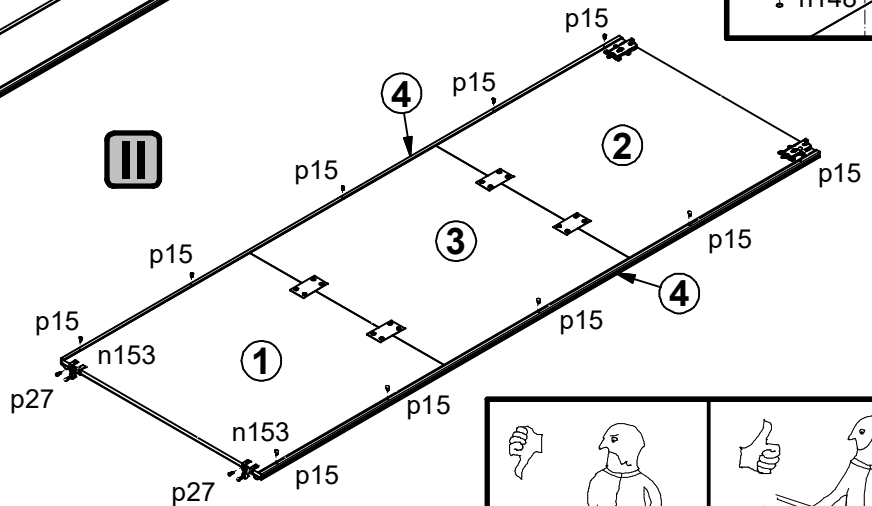
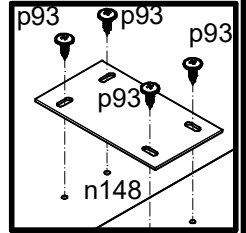
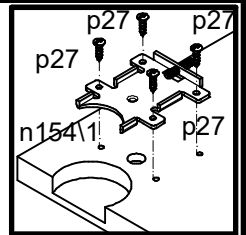
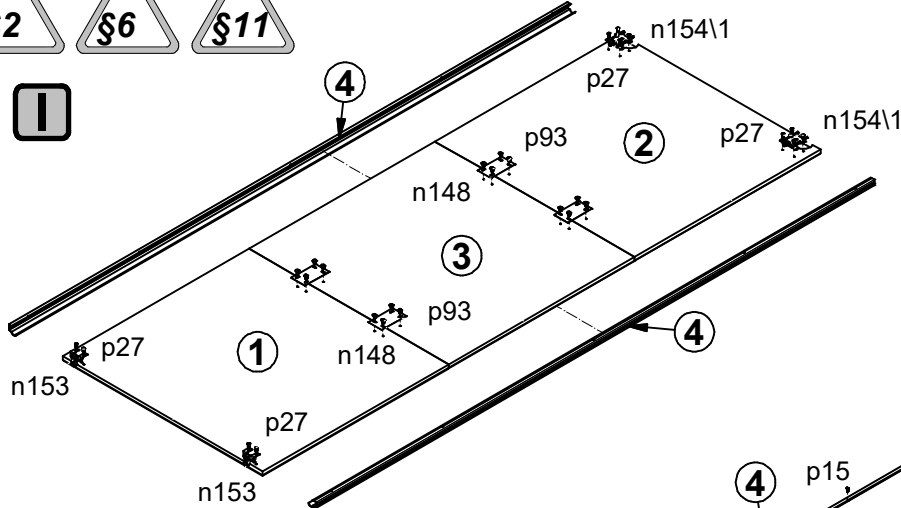
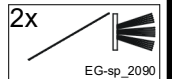
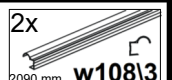
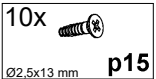
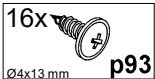
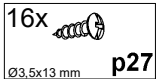
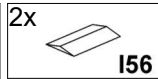
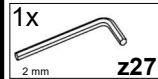
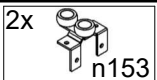
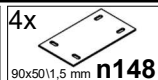
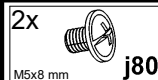
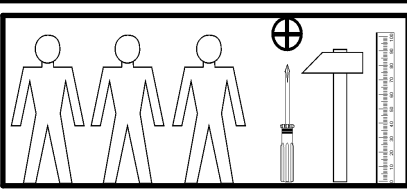
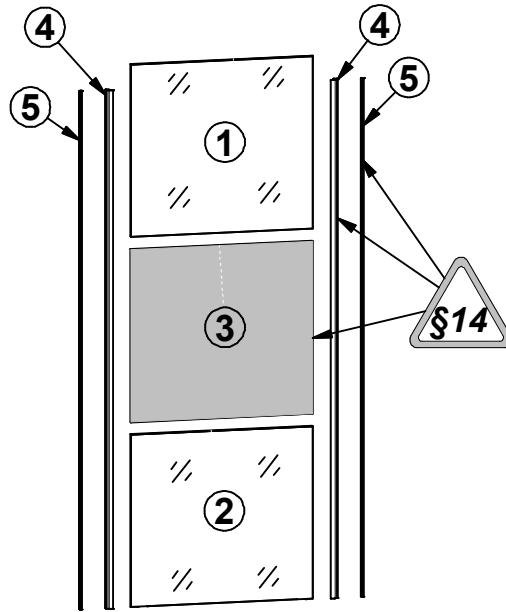

2

