

A	B	C		D	A	B	C		D
1	F57-1014	2346	449	1/5	8	F57-3029	594	339	4/5
2	F57-1015_A	2346	449	1/5	9	F57-3030	594	323	4/5
3	F57-1016_A	2346	340	2/5	10	F57-9001	1732	560	5/5
4	F57-2017	1200	450	3/5	11	F57-9002	616	560	5/5
5	F57-2018	1200	450	3/5	12	F57-9003	616	604	5/5
6	F57-3027	550	339	4/5	13	F57-9038	1732	604	5/5
7	F57-3028	550	323	4/5					

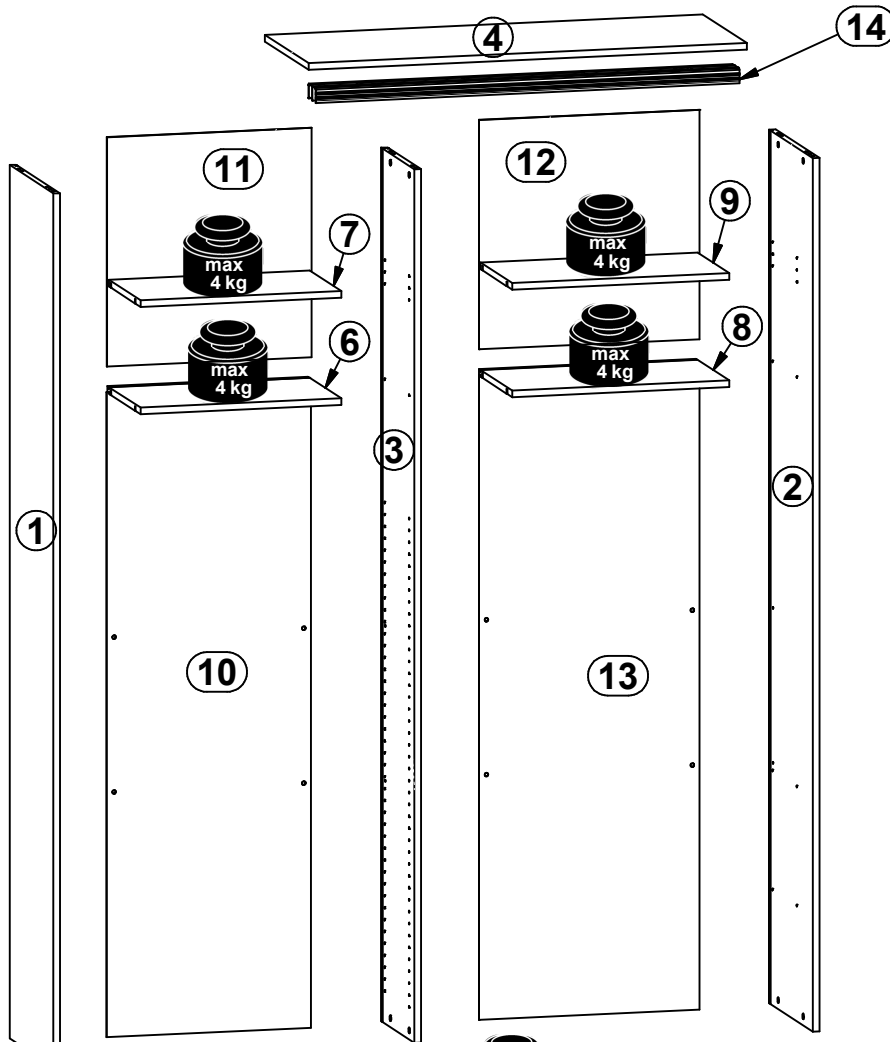

A	B	C		D
14	w106_15	1160	76	1/1
15	w107/15	1160	53	1/1

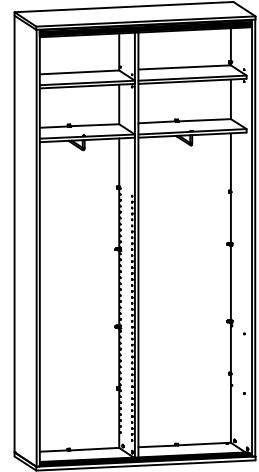
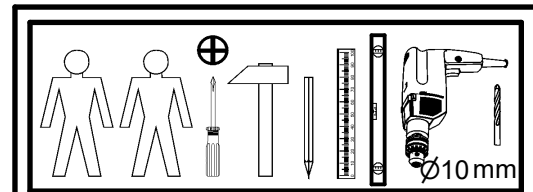

8x d20	8x Ø6.3x10 mm e50	16x Ø8x30 mm f1	2x L=296x60 g76/1	4x M4x25 mm j53	6x 32 mm k75/3	20x l2	16x Ø3.5x15 mm p51	12x Ø15x12 mm #16 r1
16x Ø20x12 mm #16 r36	16x 6,7/7,8 r37	12x 20/11 r42	6x Ø12xM10x17mm r66	12x Ø16 s2	6x Ø12x4 mm s41	1x 4 mm z15		
				2x 86x21x15/1,5 n14/2	4x Ø3,5x16 mm p38	2x Ø5x60 mm p17	2x Ø10x50 mm f35	

1 

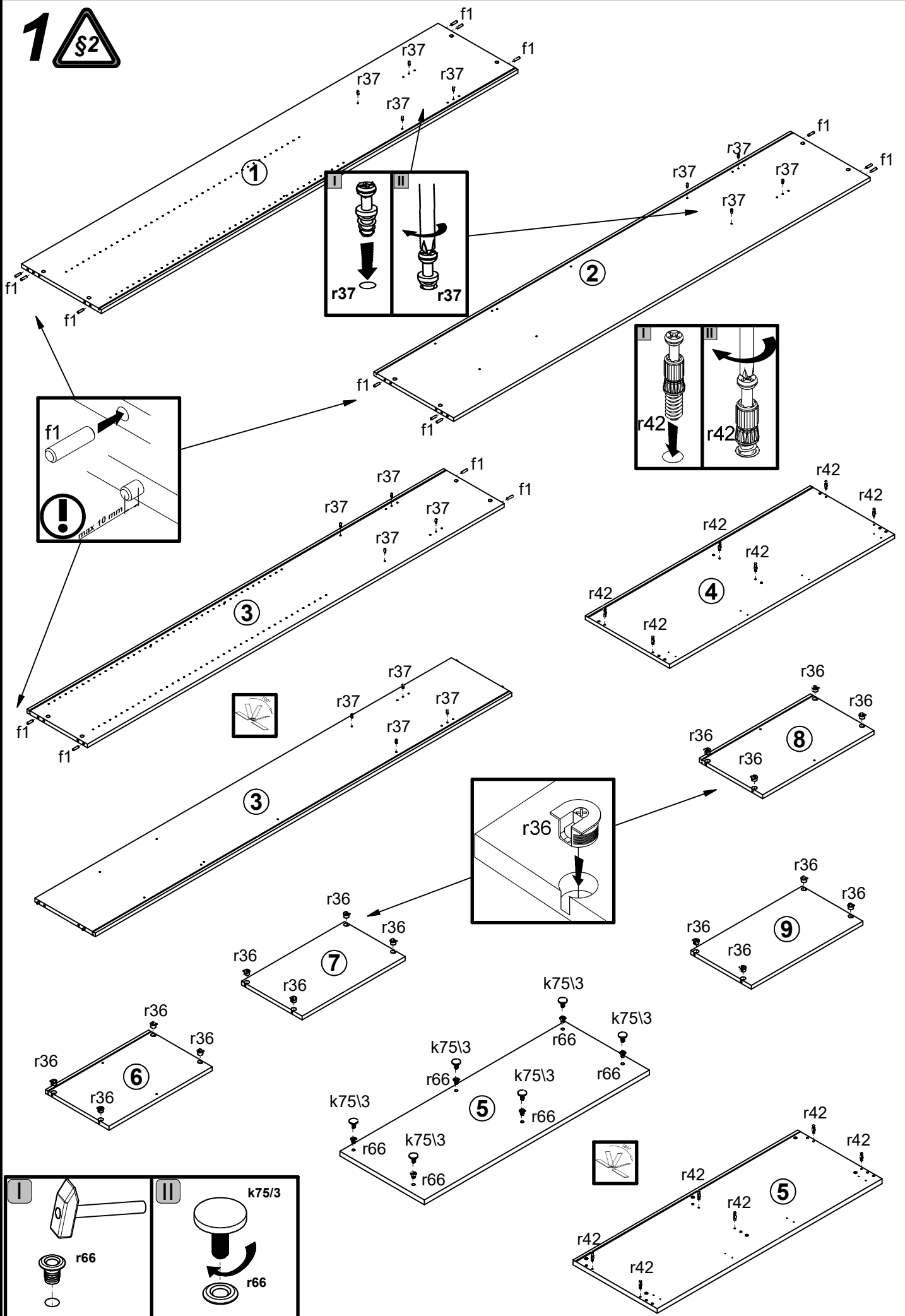

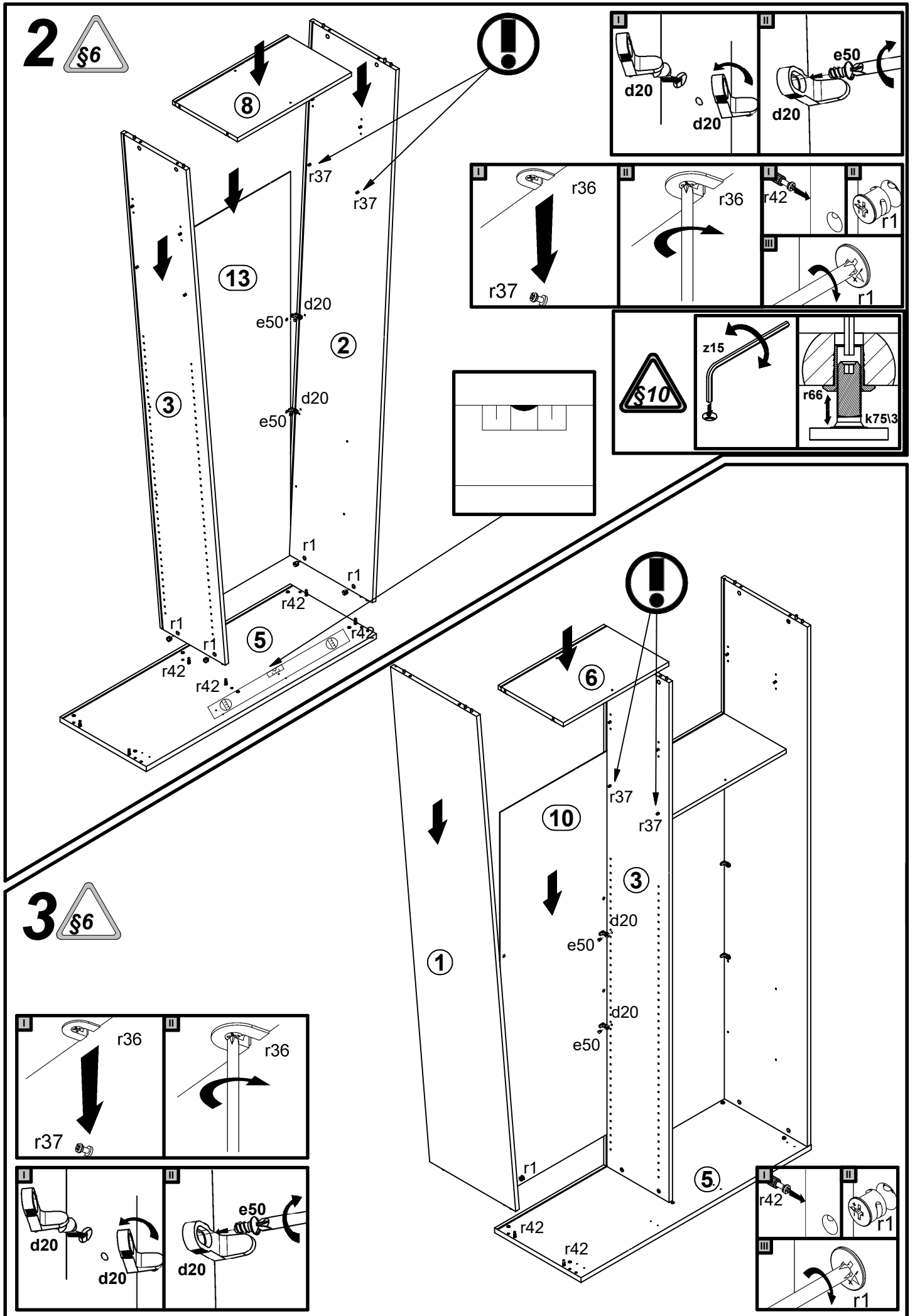

4 §6

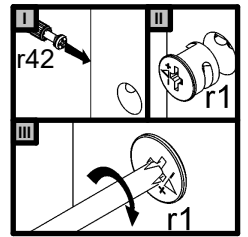
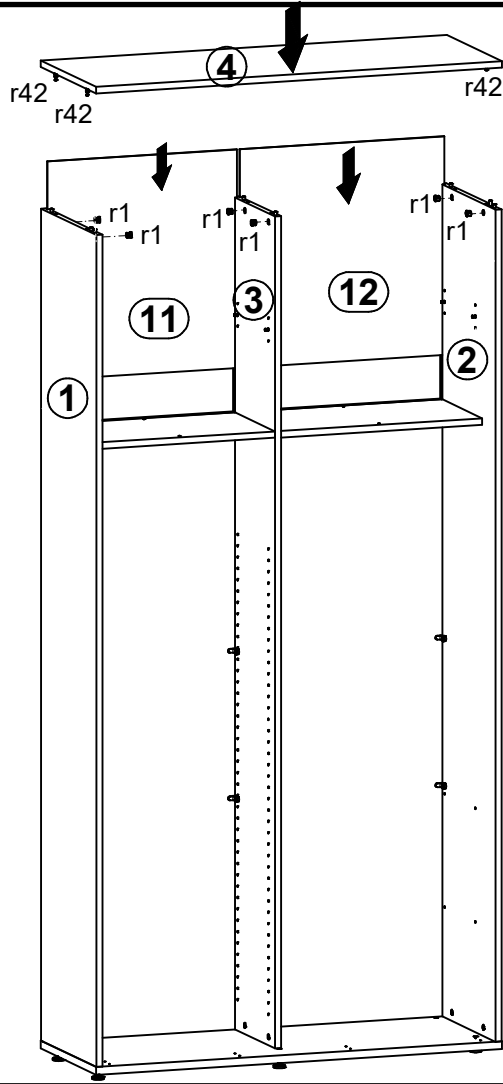

5 §6

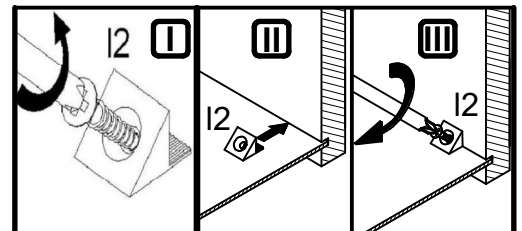
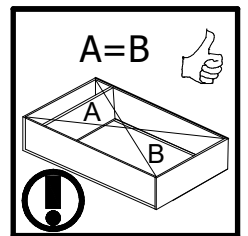
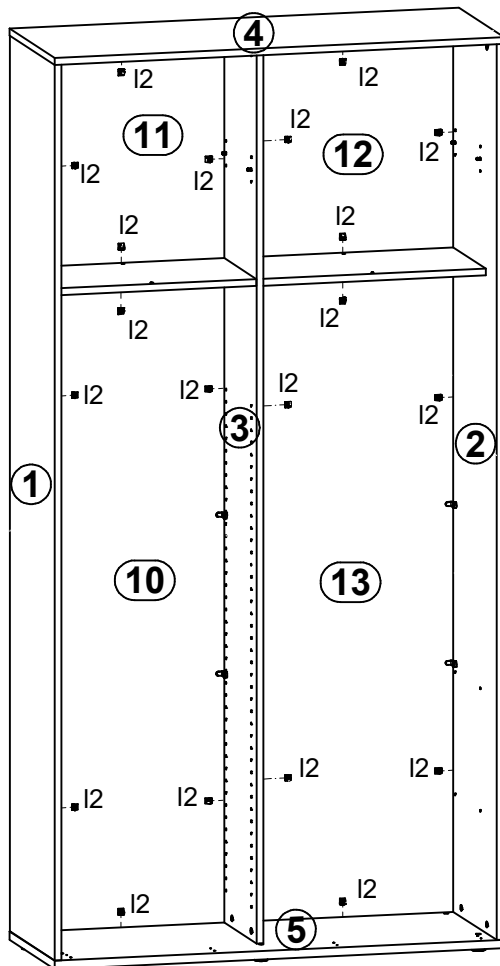

6

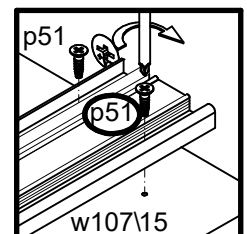
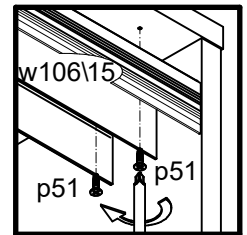
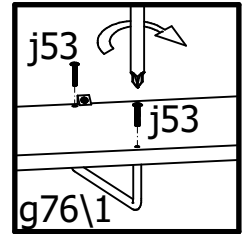
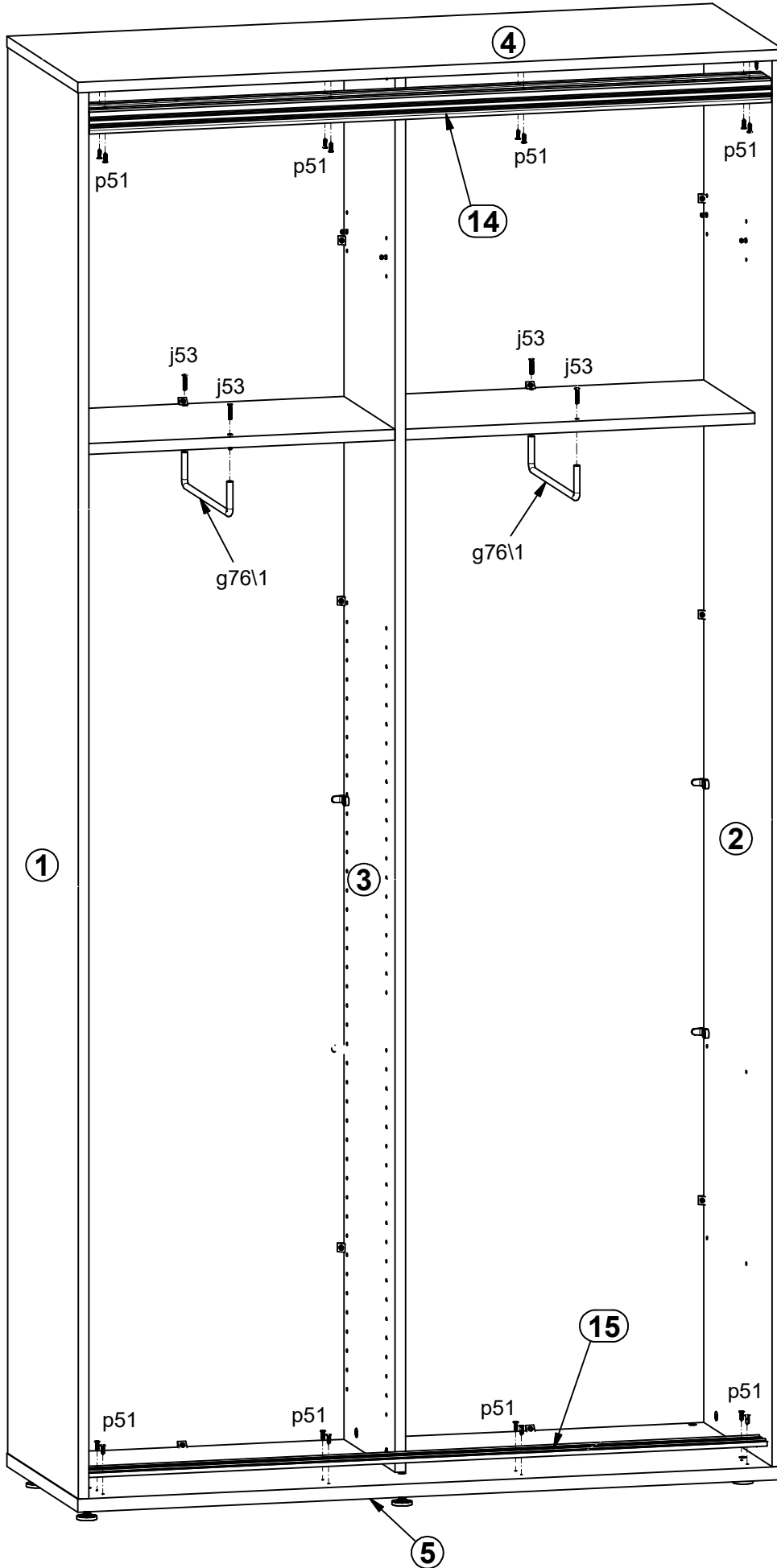

7 §6

