

A**FLEX****F57-FRN-120/218/LUS-Z**

A	B	C	D	
1	F57-0095	594	696	1/1
2	F57-0096	594	696	1/1



3		594	696	1/1
---	--	-----	-----	-----



4	w108\3	2090	-	1/2
5	Eg-sp_2090	2090	-	2/2

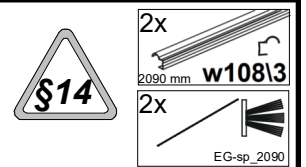
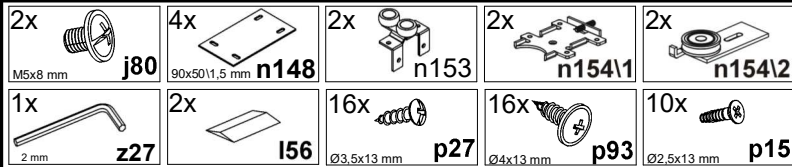
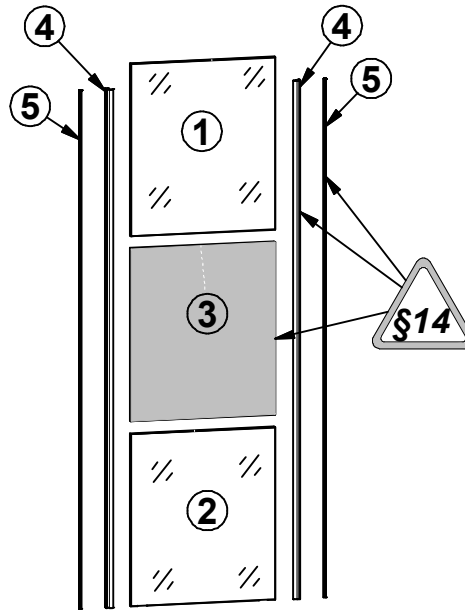
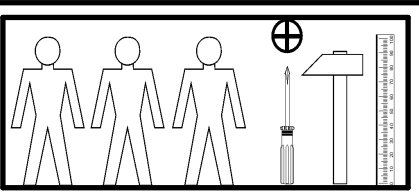

1 §2 §6 §11

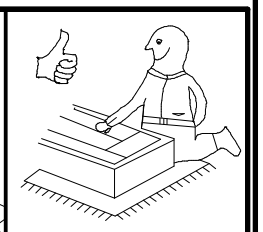
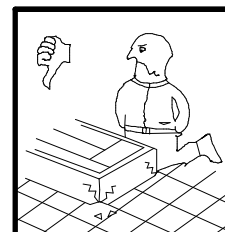
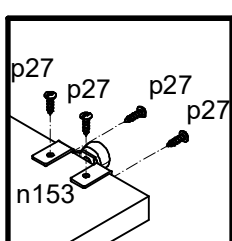
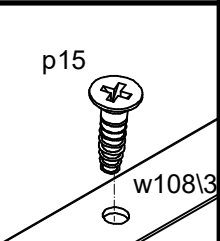
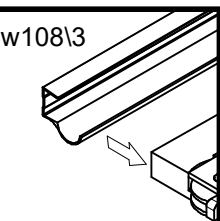
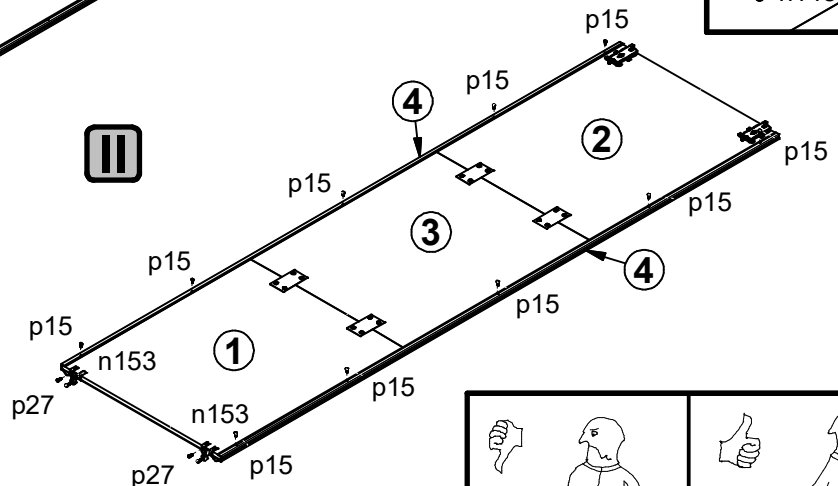
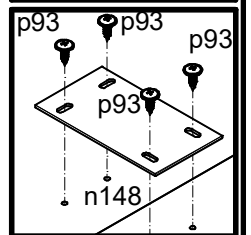
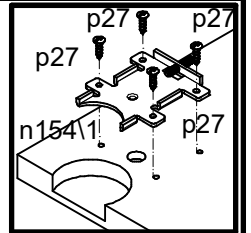
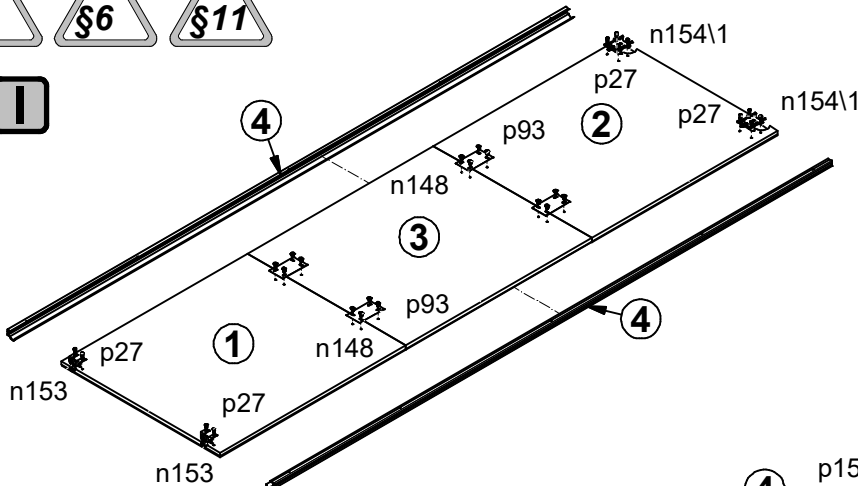

2

