

A

FLEX

F57-SZF/220/240/66

A	B	C	D	A	B	C	D		
1	F57-1001	2346	659	1\5	11	F57-3019	507	533	4\5
2	F57-1003	2346	550	2\5	12	F57-9001	1732	560	5\5
3	F57-1005	606	533	4\5	13	F57-9002	616	560	5\5
4	F57-1006	2346	550	2\5	14	F57-9306	1732	1041	5\5
5	F57-1010	2346	659	1\5	15	F57-9328	616	1041	5\5
6	F57-2011	2207	660	3\5	16	g47\19	545	0	4\5
7	F57-2012	2207	660	3\5	17	g47\3	1030	0	4\5
8	F57-3001	550	549	4\5					
9	F57-3002	550	533	4\5					
10	F57-3018	1033	549	4\5					

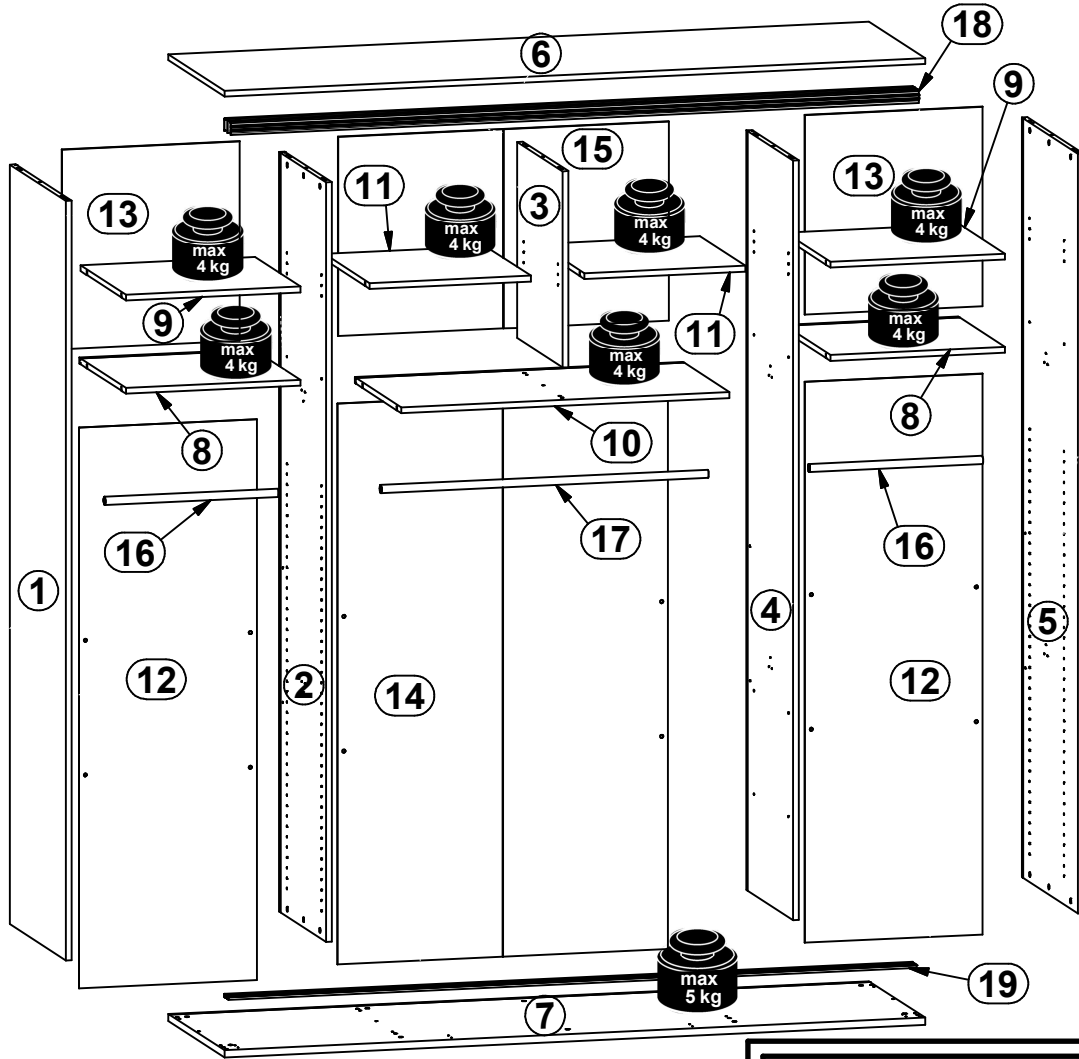
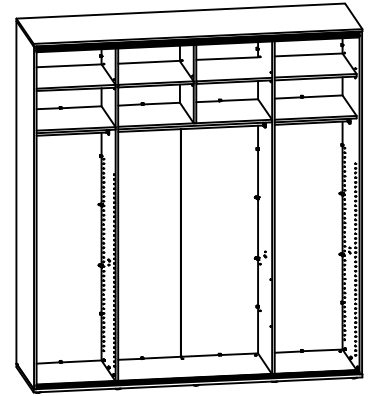

A	B	C	D	
18	w106\10	2167	76	1\1
19	w107\10	2167	53	1\1

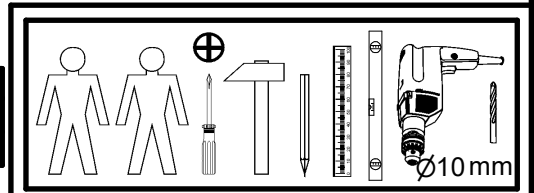

12x d20	18x Ø6x13 mm e3	12x Ø6,3x10 mm e50	24x Ø8x30 mm f1	2x Ø10x50 mm f35	6x g46	10x 32 mm k75\3	34x l2	2x 86x21x15\1,5 n14\2
2x Ø5x60 mm p17	4x Ø3,5x16 mm p38	16x Ø3,5x15 mm p51	30x Ø15x12 mm #16 r1	28x Ø20x12 mm #16 r36	28x 6,7\7,8 r37	30x 20\11 r42	10x Ø12xM10x17mm r66	30x Ø16 s2
10x Ø12x4 mm s41	1x 4 mm z15	1x 3 mm z22						

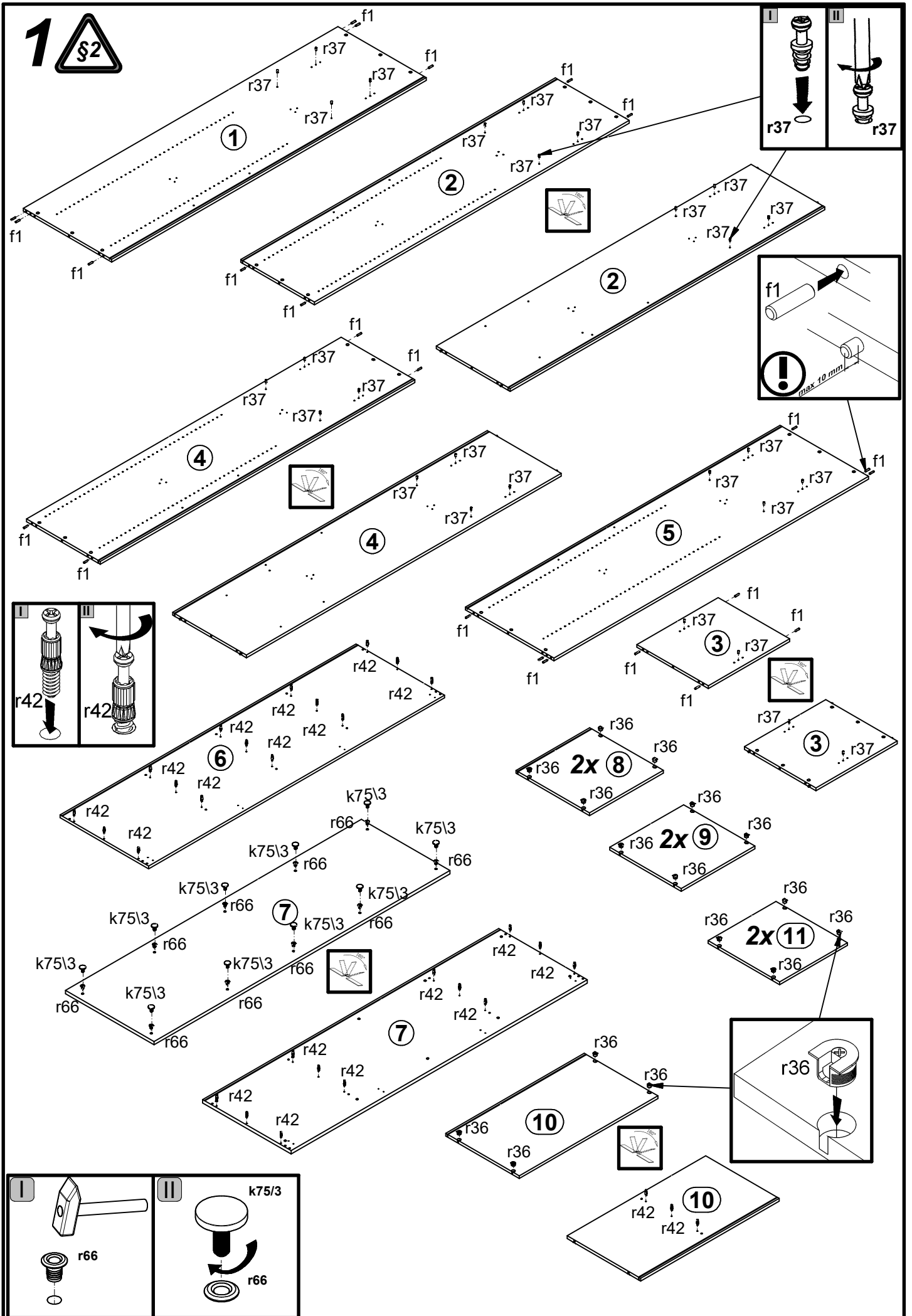

2

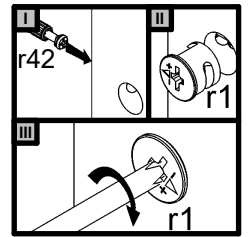
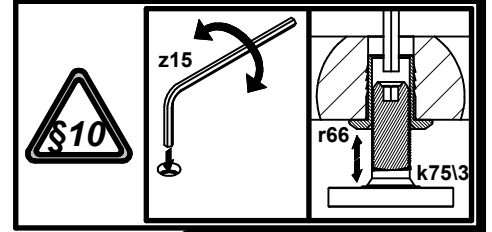
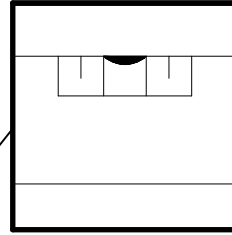
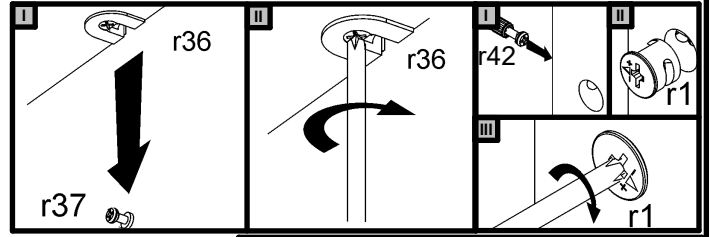
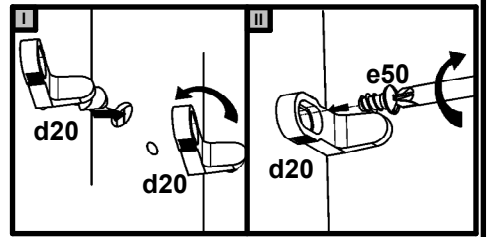
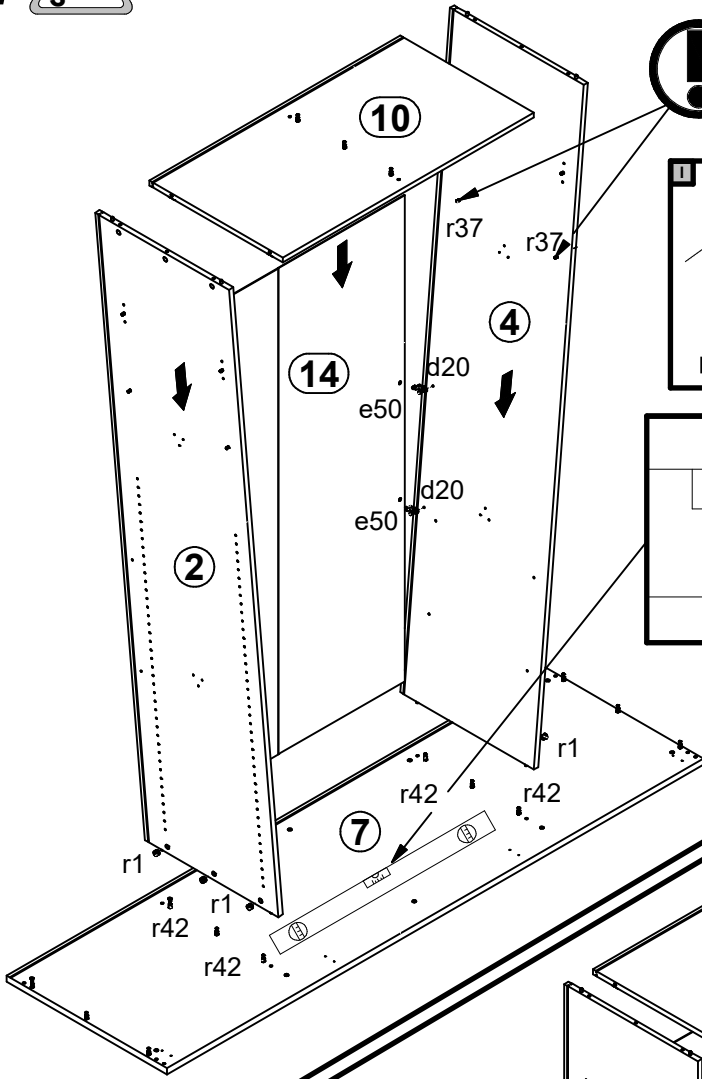

3

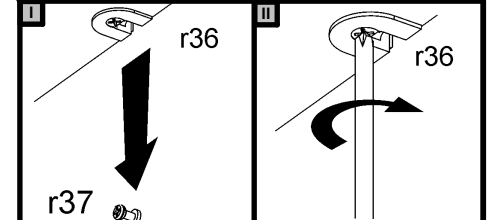
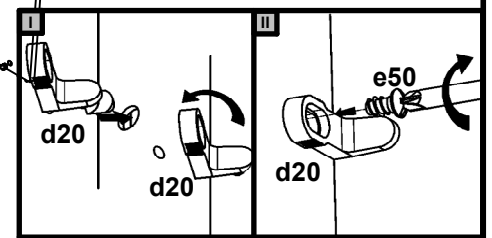
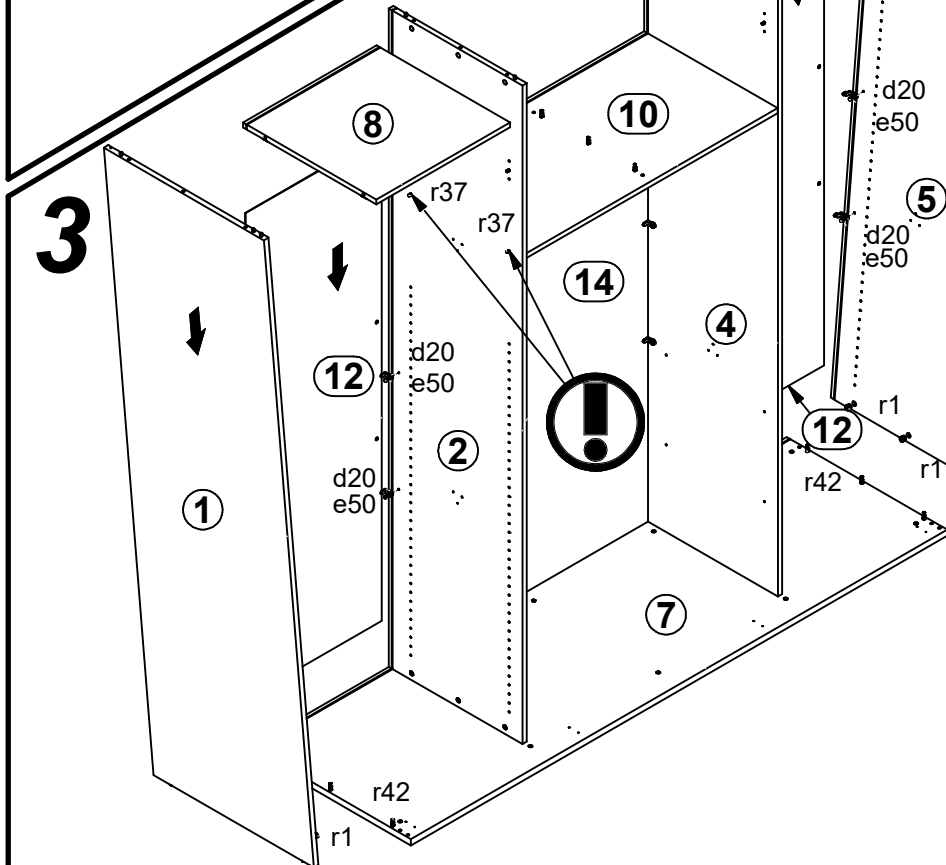

4

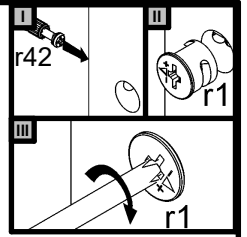
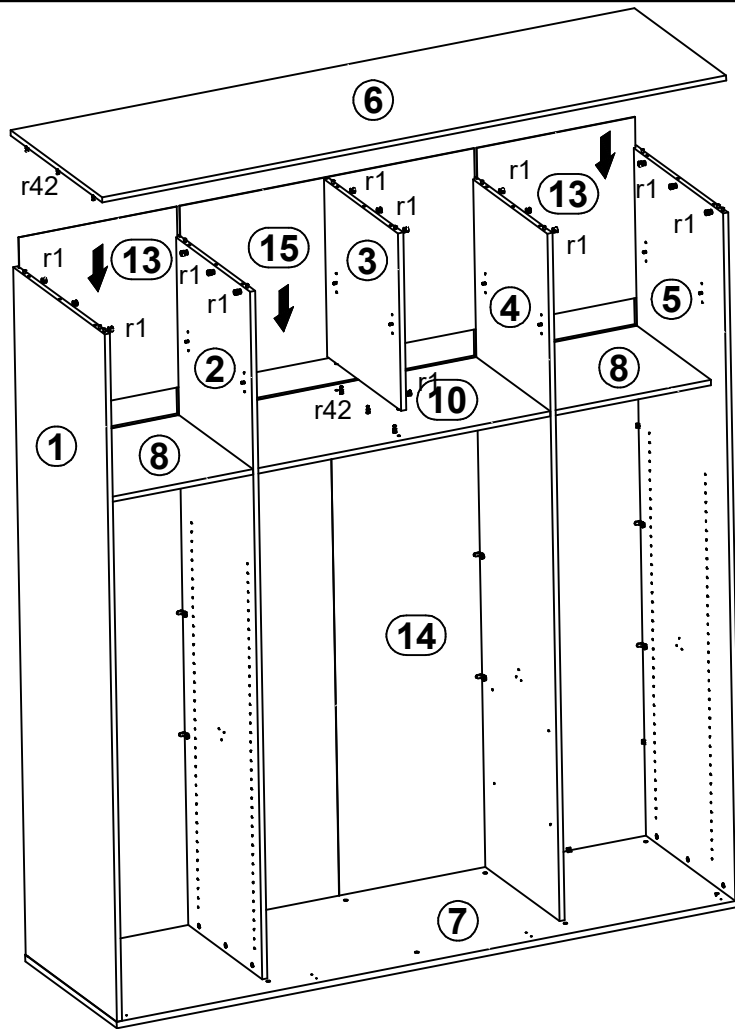

5

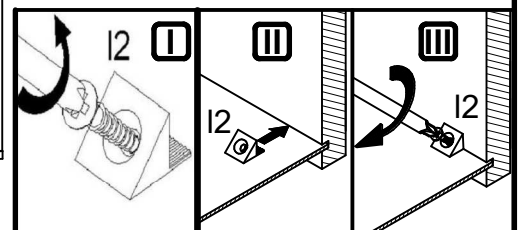
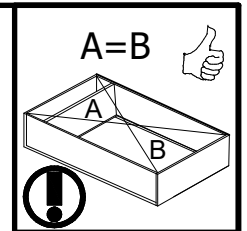
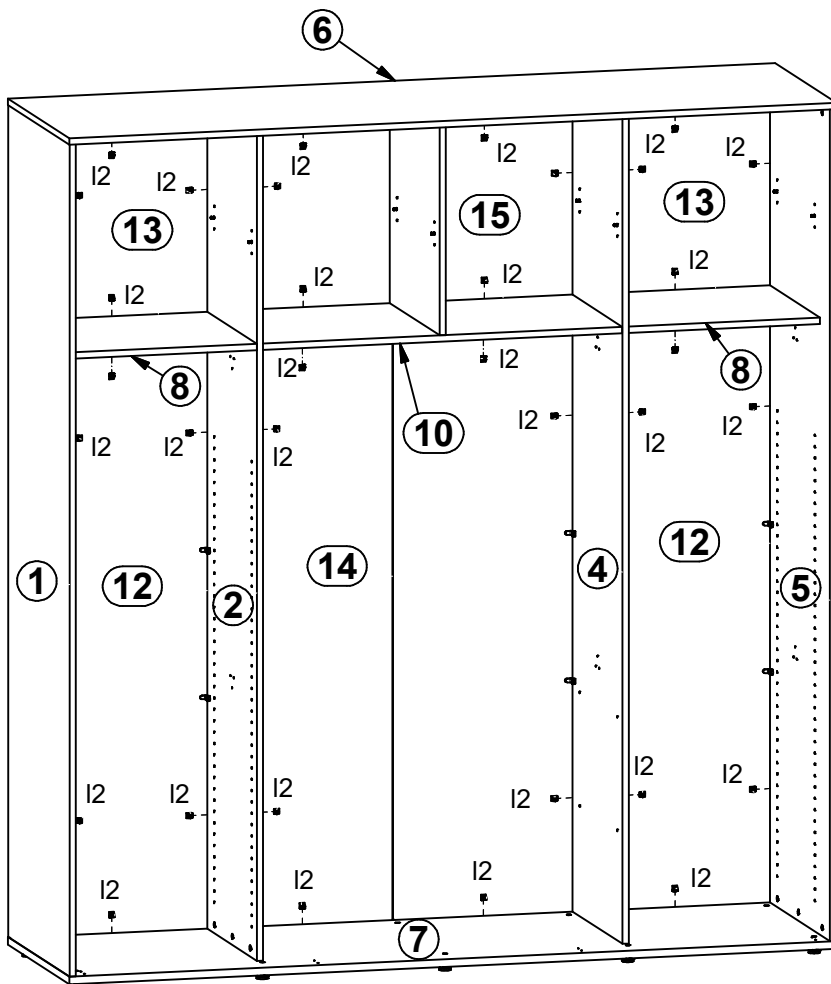

6

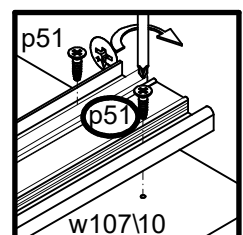
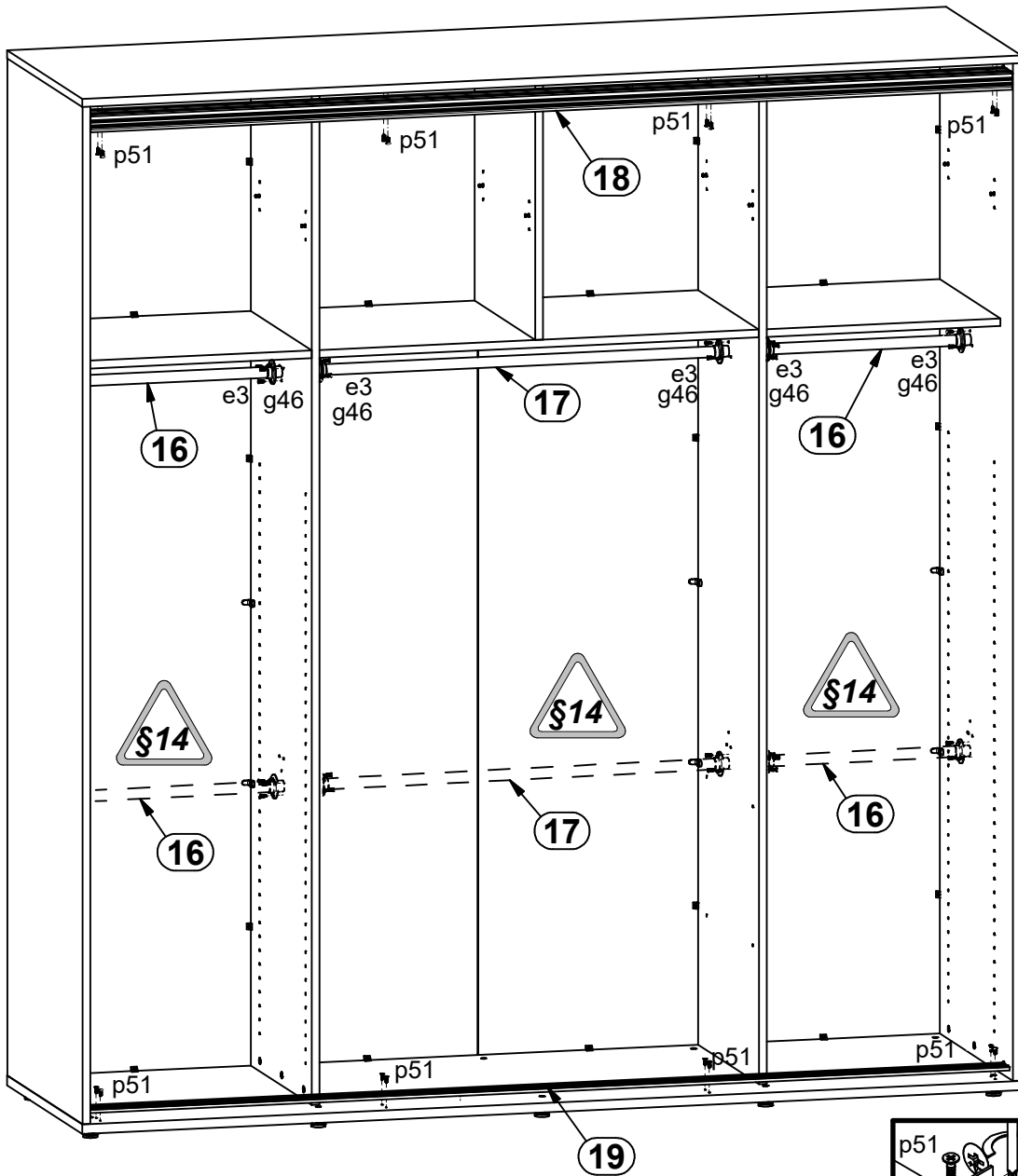
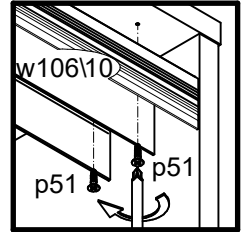
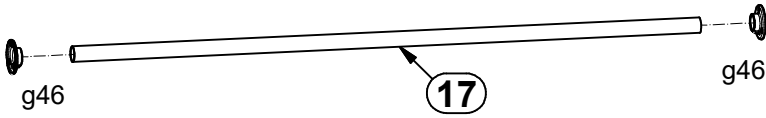
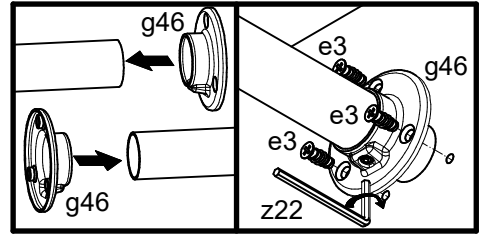
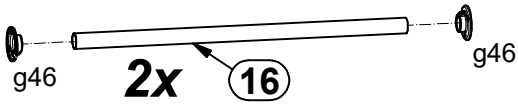

7

