

A	B	C	D	A	B	C	D	
1	F57-1001	2346	659	1/5	9	F57-3012	1201 549	4/5
2	F57-1002	2346	659	1/5	10	F57-3013	591 533	4/5
3	F57-1003	2346	550	2/5	11	F57-9001	1732 560	5/5
4	F57-1005	606	533	4/5	12	F57-9002	616 560	5/5
5	F57-2007	1807	660	3/5	13	F57-9304	1732 1211	5/5
6	F57-2008	1807	660	3/5	14	F57-9326	616 1211	5/5
7	F57-3001	550	549	4/5	15	g47\19	545 0	4/5
8	F57-3002	550	533	4/5	16	g47\23	1196 0	4/5

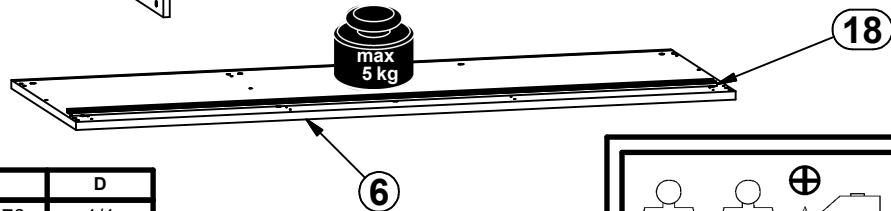

A	B	C	D
17	w106\7	1767	76 1/1
18	w107\7	1767	53 1/1

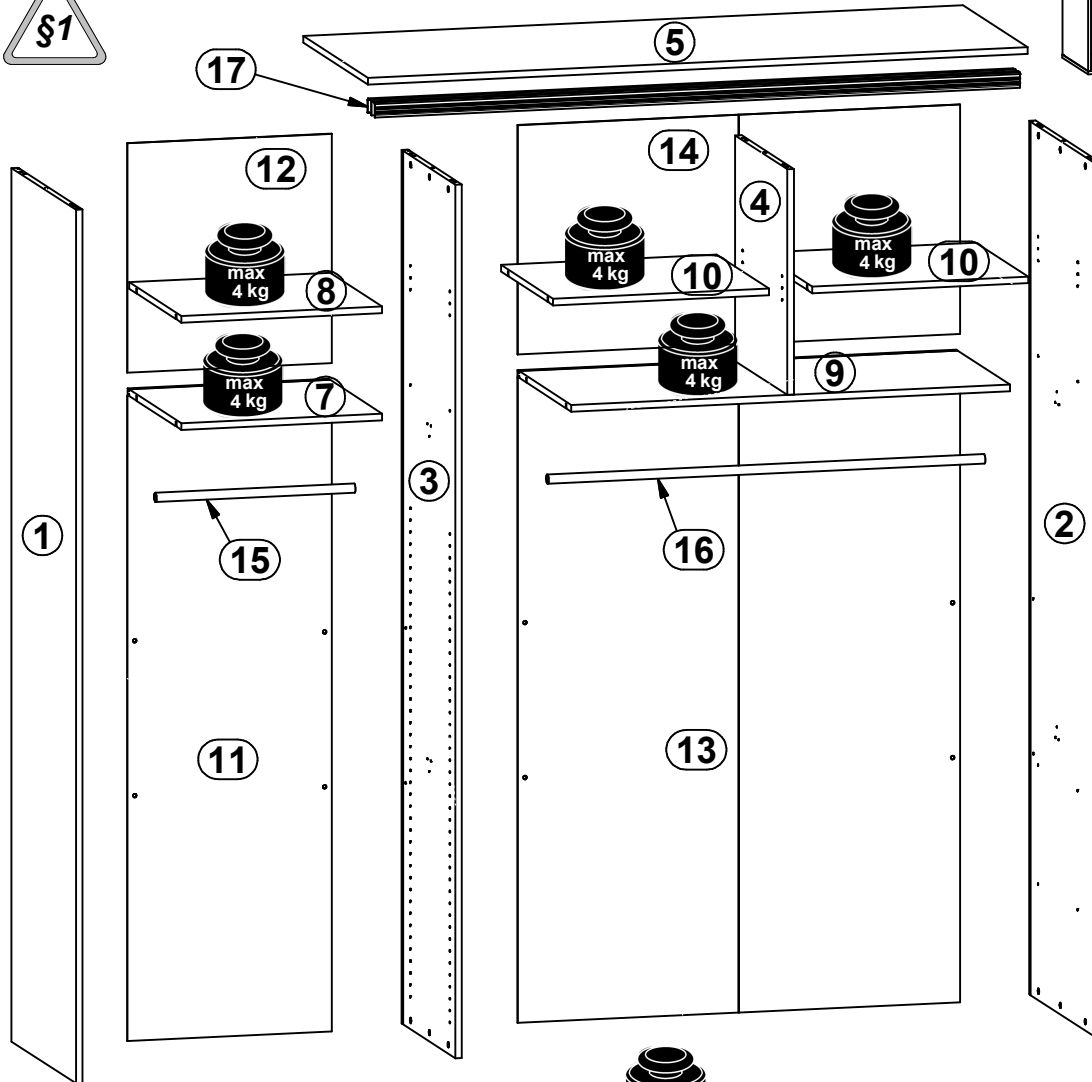
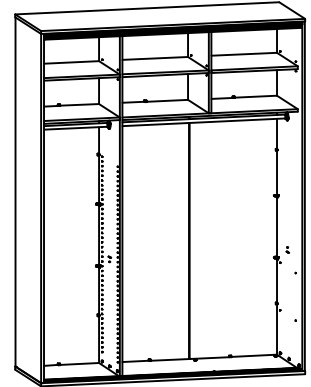
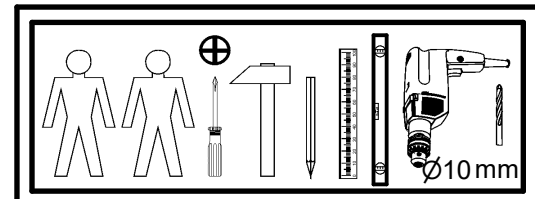

8x d20	12x Ø6x13 mm e3	8x Ø6.3x10 mm e50	20x Ø8x30 mm f1	4x g46	9x 32 mm k75\3	24x l2	16x Ø3.5x15 mm p51	24x Ø15x12 mm #16 r1
20x Ø20x12 mm #16 r36	20x 6.7\7.8 r37	24x 20\11 r42	9x Ø12xM10x17mm r66	24x Ø16 s2	9x Ø12x4 mm s41	1x 4 mm z15	1x 3 mm z22	
				2x 88x21x15\1.5 n14\2	4x Ø3.5x16 mm p38	2x Ø5x60 mm p17	2x Ø10x50 mm f35	

1 

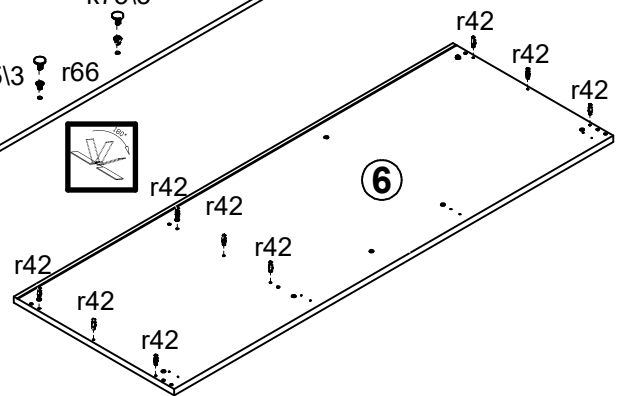
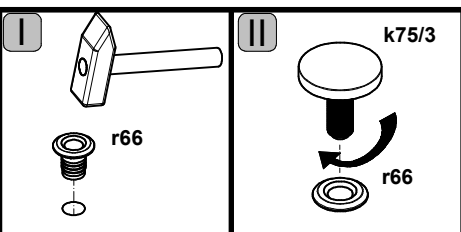
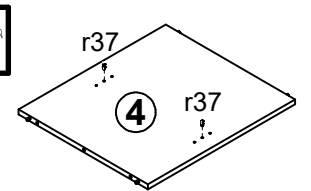
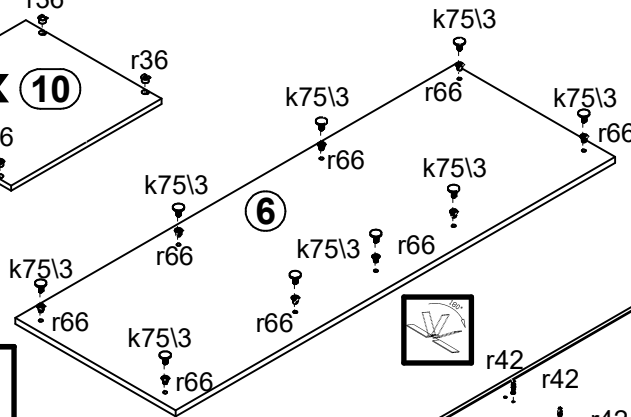
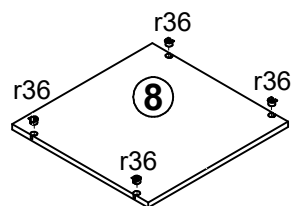
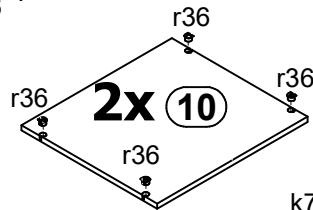
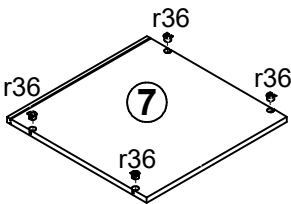
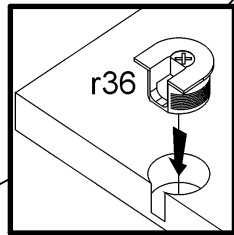
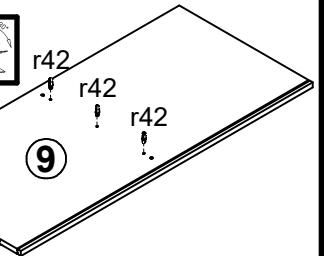
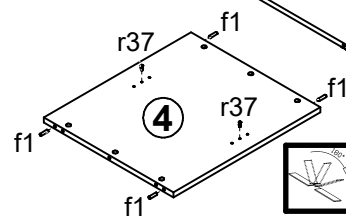
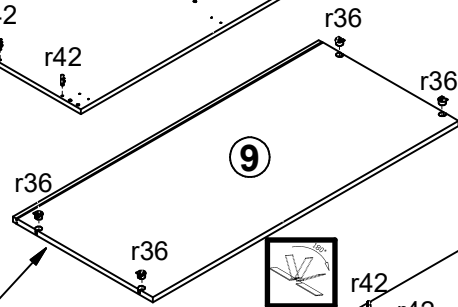
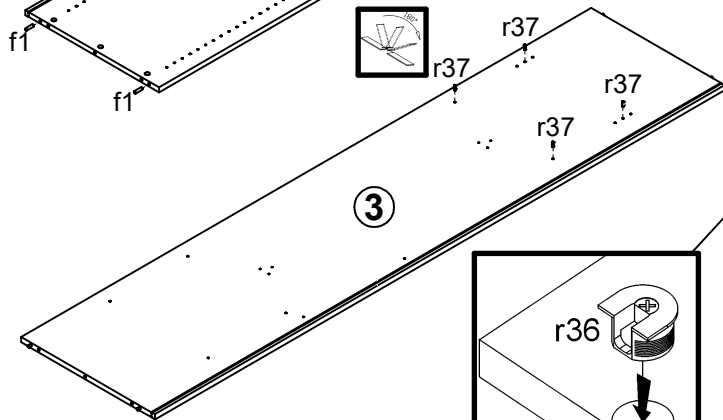
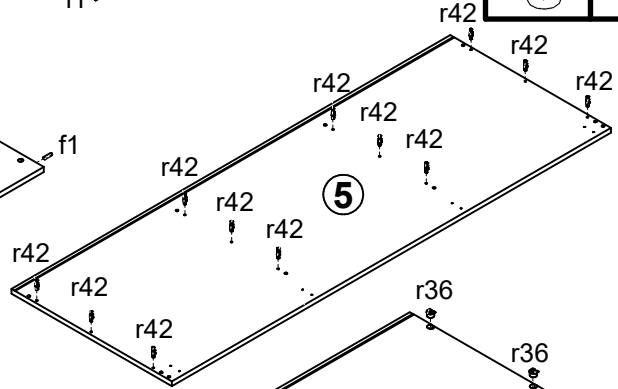
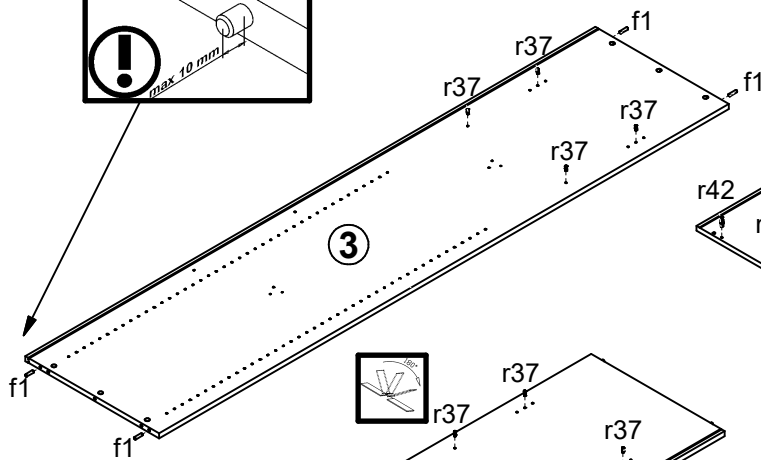
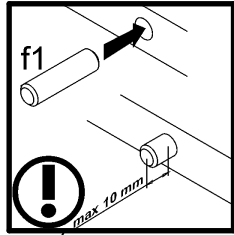
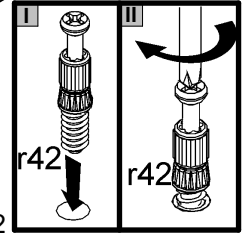
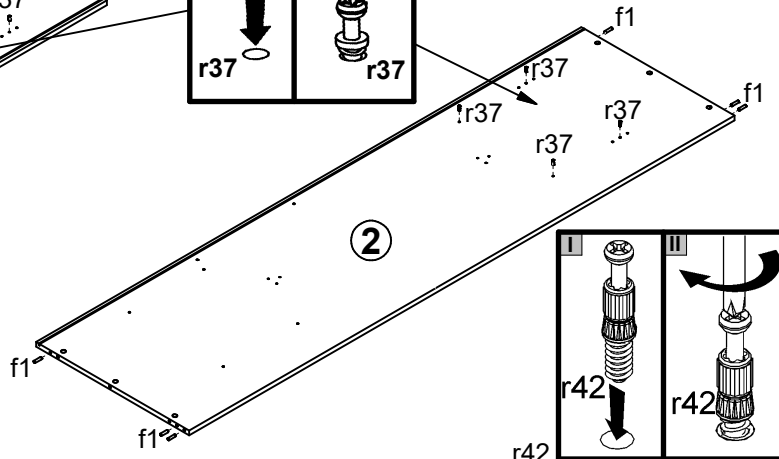
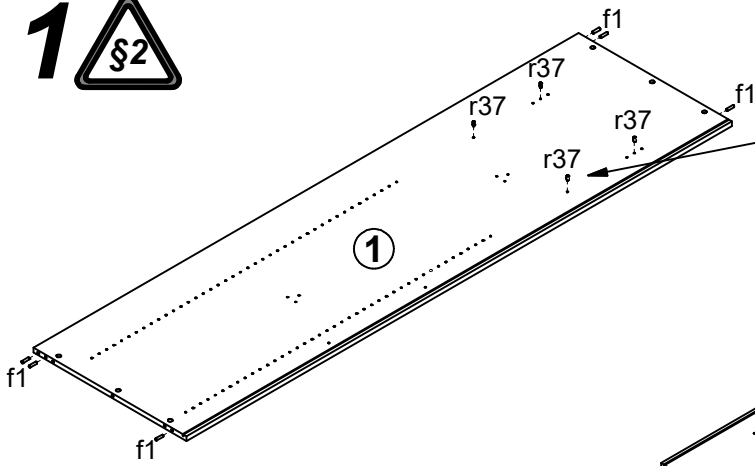
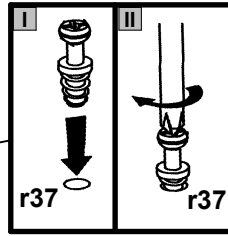

4 §6

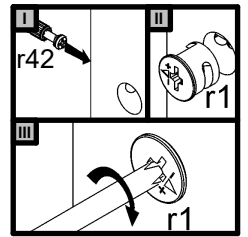
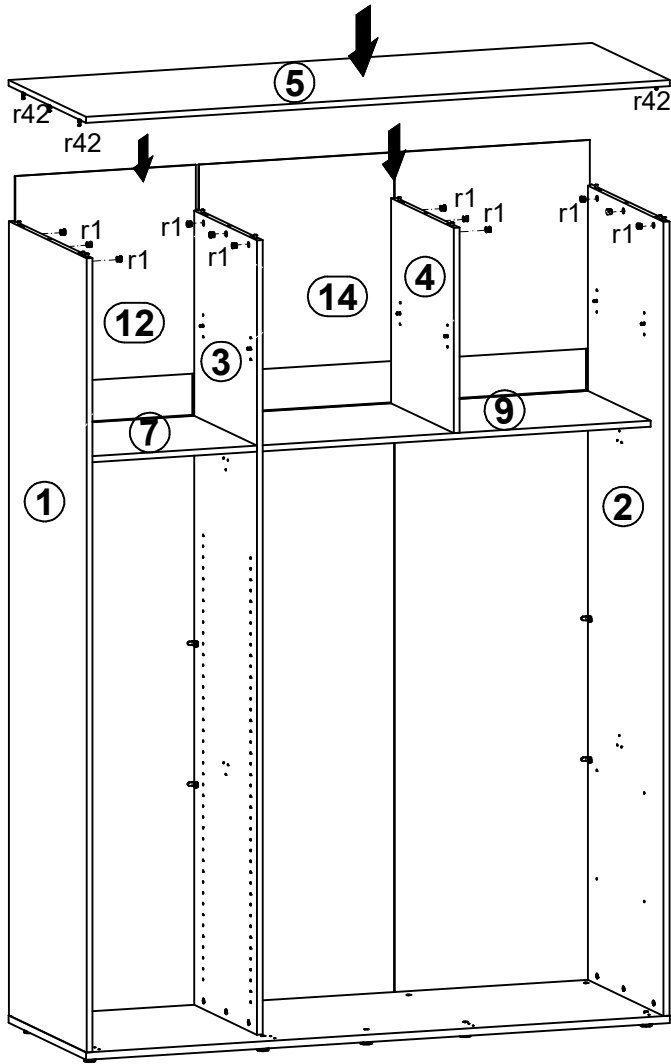

5 §6

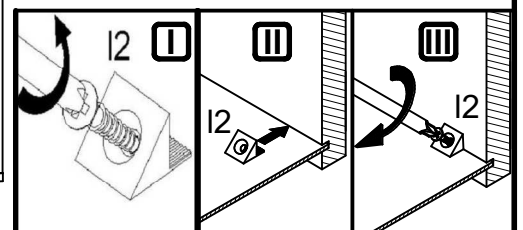
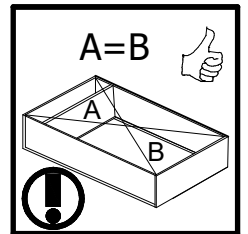
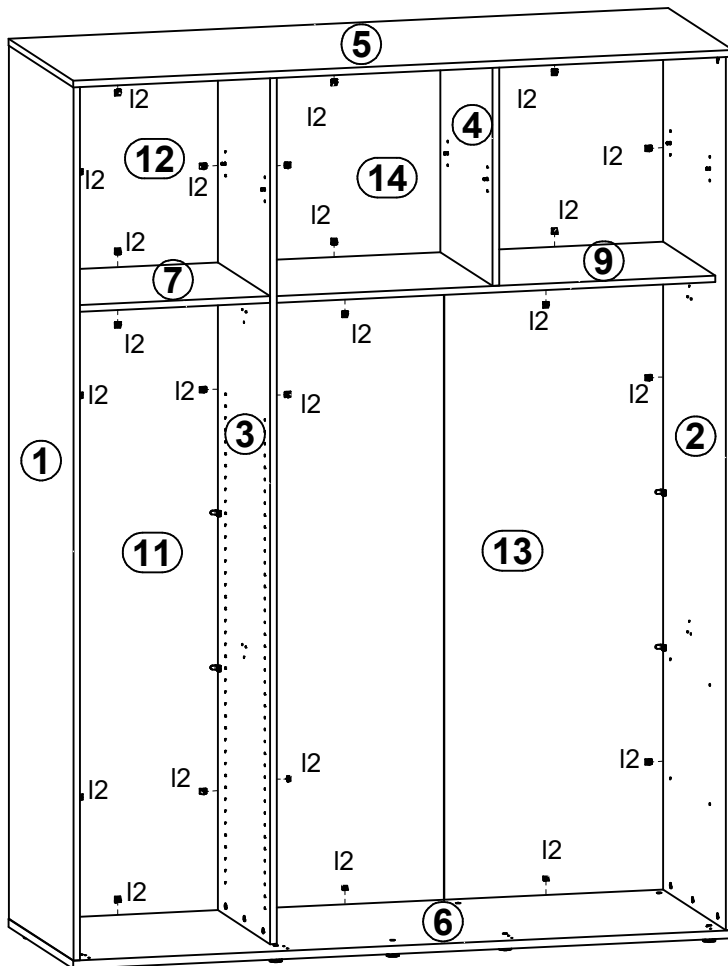

6

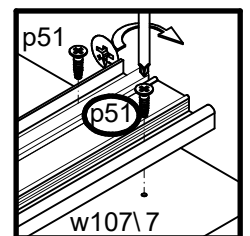
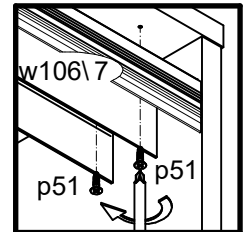
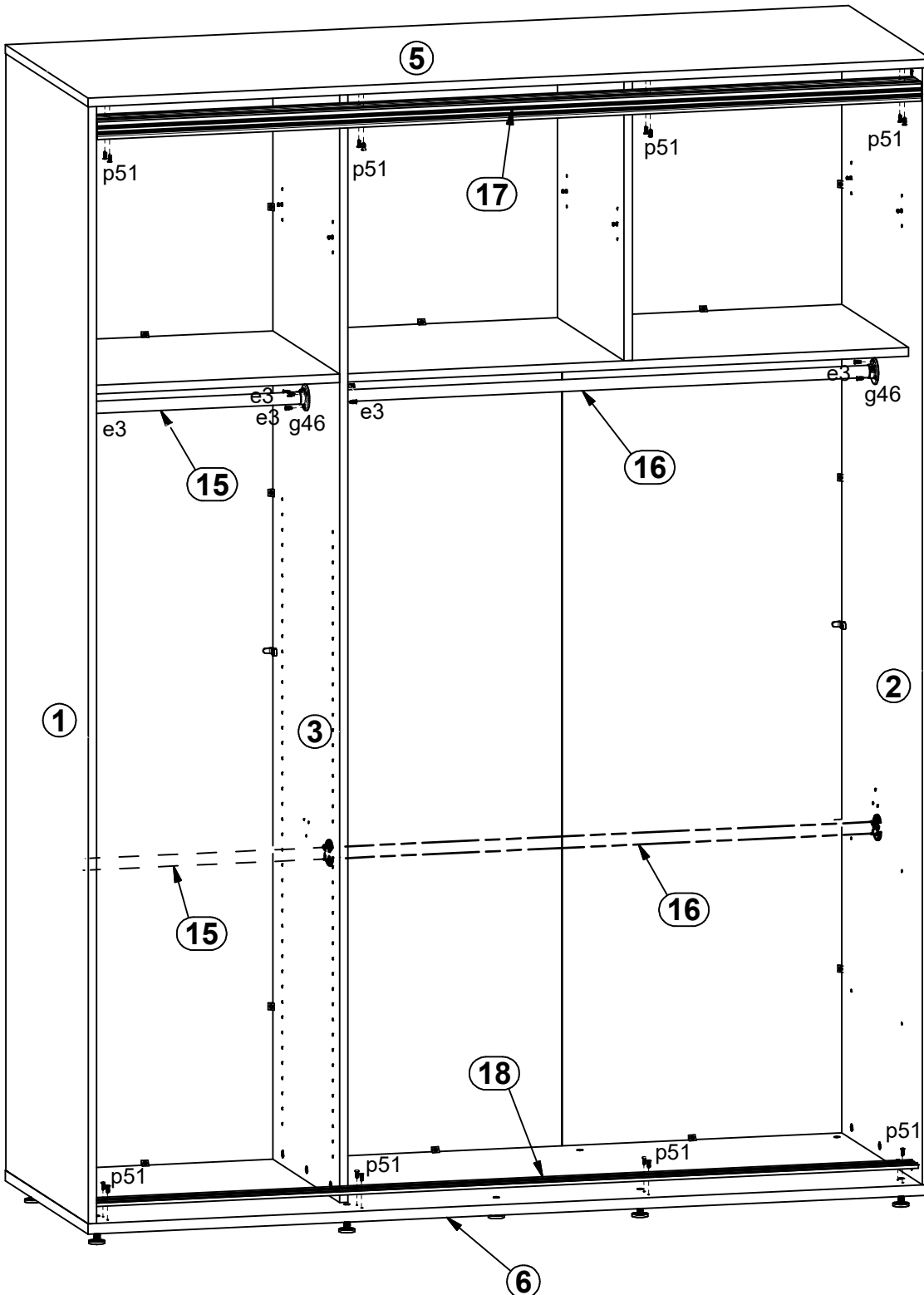
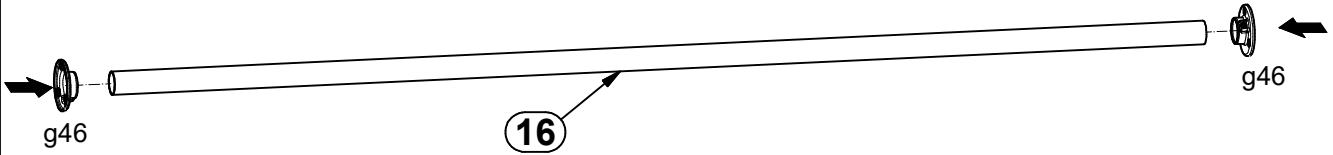
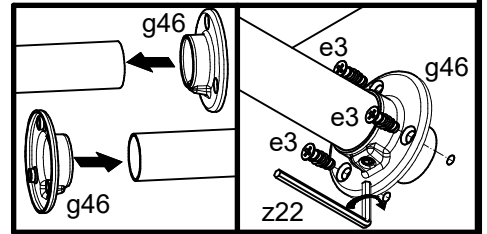
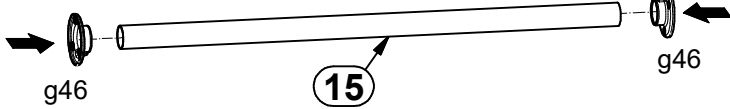

7 §6

