

A	B	C	D	A	B	C	D		
1	S440-0021	515	200	2/2	13	S440-4031	584	60	2/2
2	S440-0022	515	200	2/2	14	S440-5015	100	60	2/2
3	S440-0025	1390	297	1/2	15	S440-5049	514	360	2/2
4	S440-1047	1544	396	1/2	16	S440-5050	582	360	2/2
5	S440-1048	1544	396	1/2	17	S440-5051	1480	80	1/2
6	S440-1049	1469	376	1/2	18	S440-5052	1480	80	1/2
7	S440-3028	949	376	2/2	19	S440-9016	1487	362	1/2
8	S440-3029	584	376	2/2	20	S440-9309	1487	597	1/2
9	S440-3030	350	376	2/2	21	S493-0024	515	660	2/2
10	S440-3031	583	370	2/2	22	S493-2012	980	396	2/2
11	S440-3032	349	370	2/2	23	S493-5105	982	80	2/2
12	S440-4030	949	60	2/2					

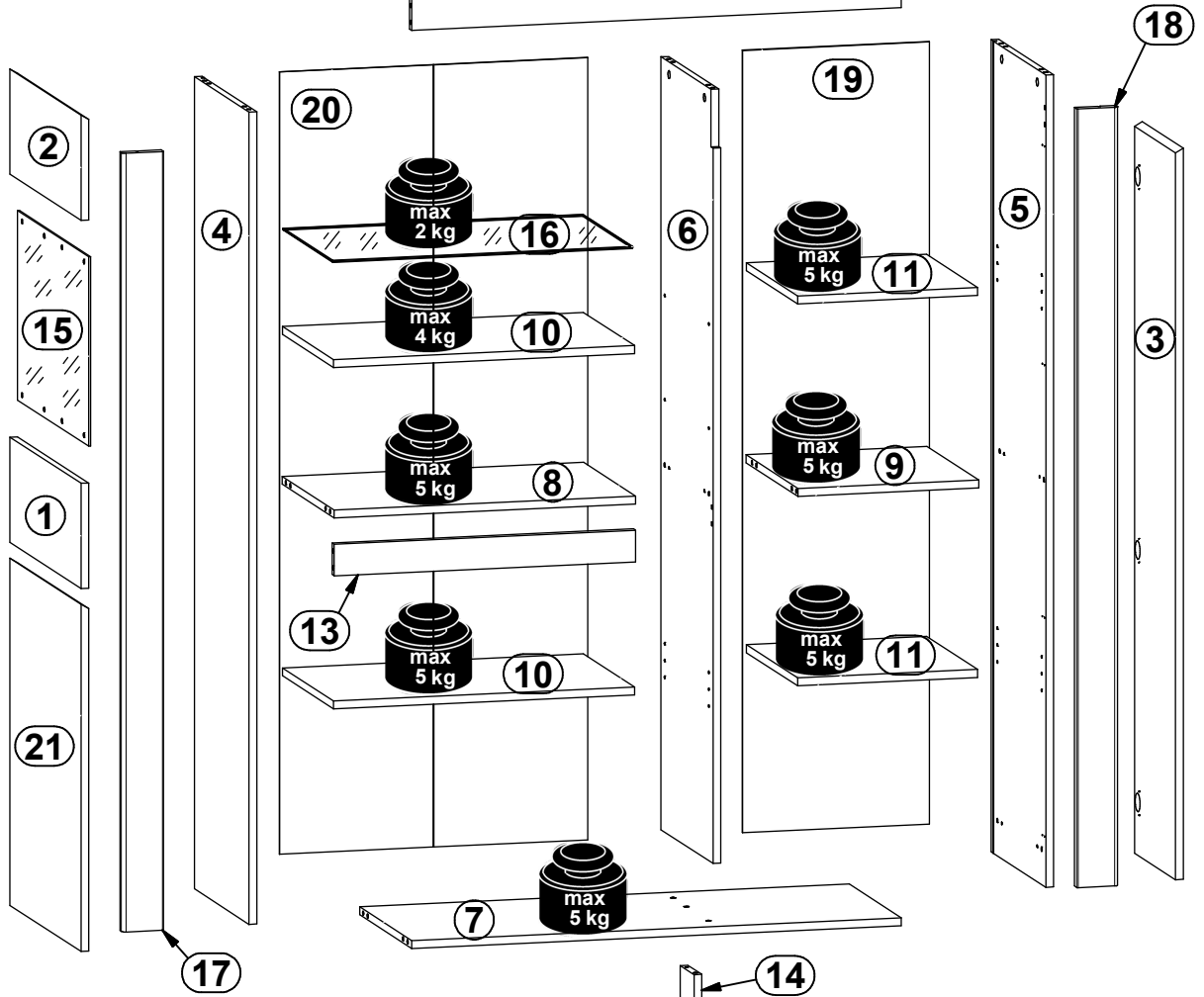

7x a132	3x a133	7x b43	16x d1 Ø5x17 mm	4x d3 Ø5x17 mm	2x d36	8x d37	3x e1 Ø7x50 mm	14x e2 Ø6.3x13 mm
8x e47 Ø5x16 mm	27x f1 Ø8x30 mm	5x k1	10x i2	7x n108 22x9.5x20.7 mm	8x o54 Ø5.3/Ø8.3x4.8 mm	37x p38 Ø3.5x16 mm	14x p51 Ø2.9x15 mm	17x p55 Ø2.9x16 mm
18x r1 Ø15x12 mm #16	18x r42 20/11	6x s68 Ø 20mm	1x z1 4 mm					1x n26

1 

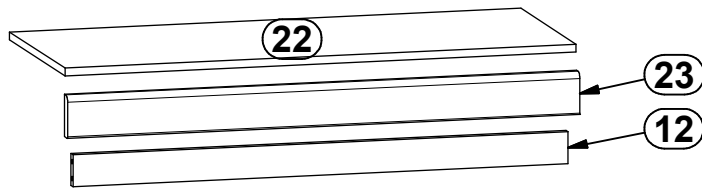
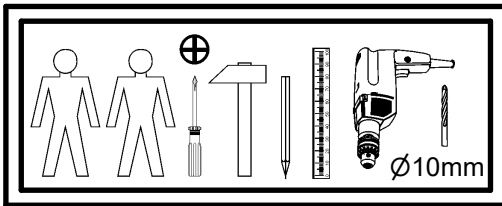
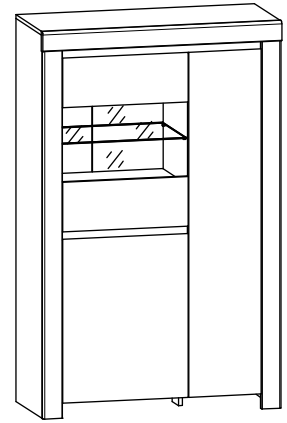
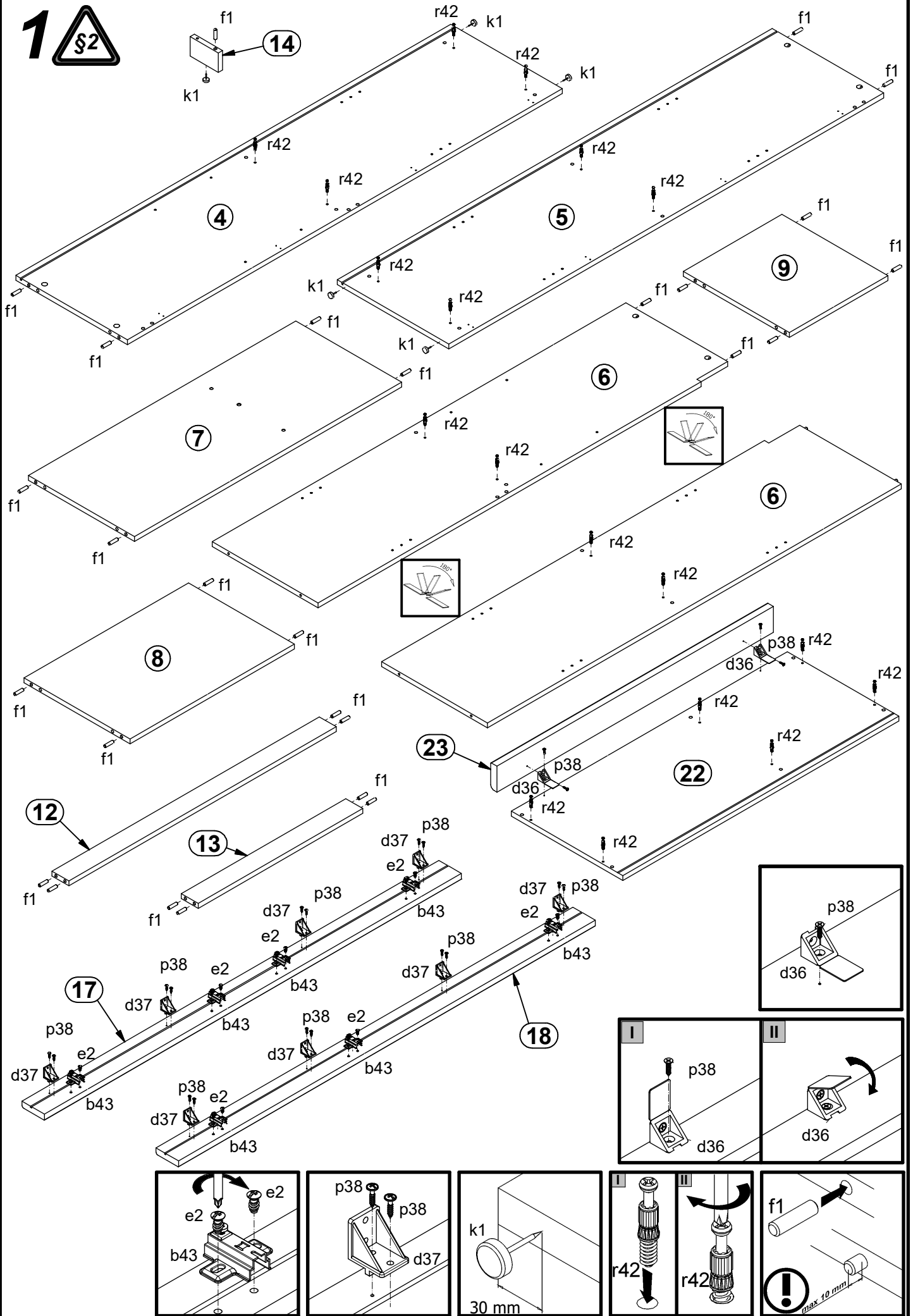

2

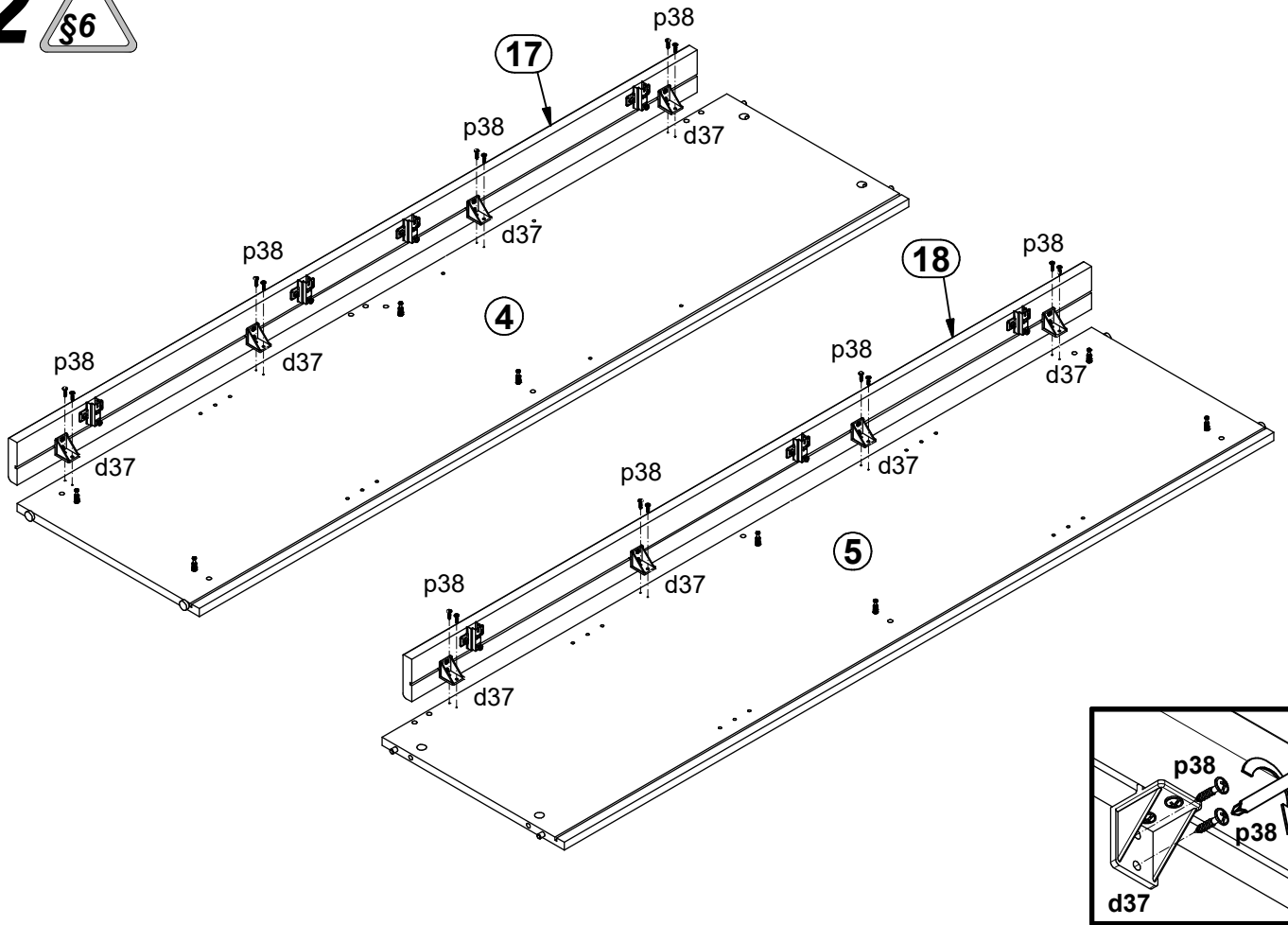

3

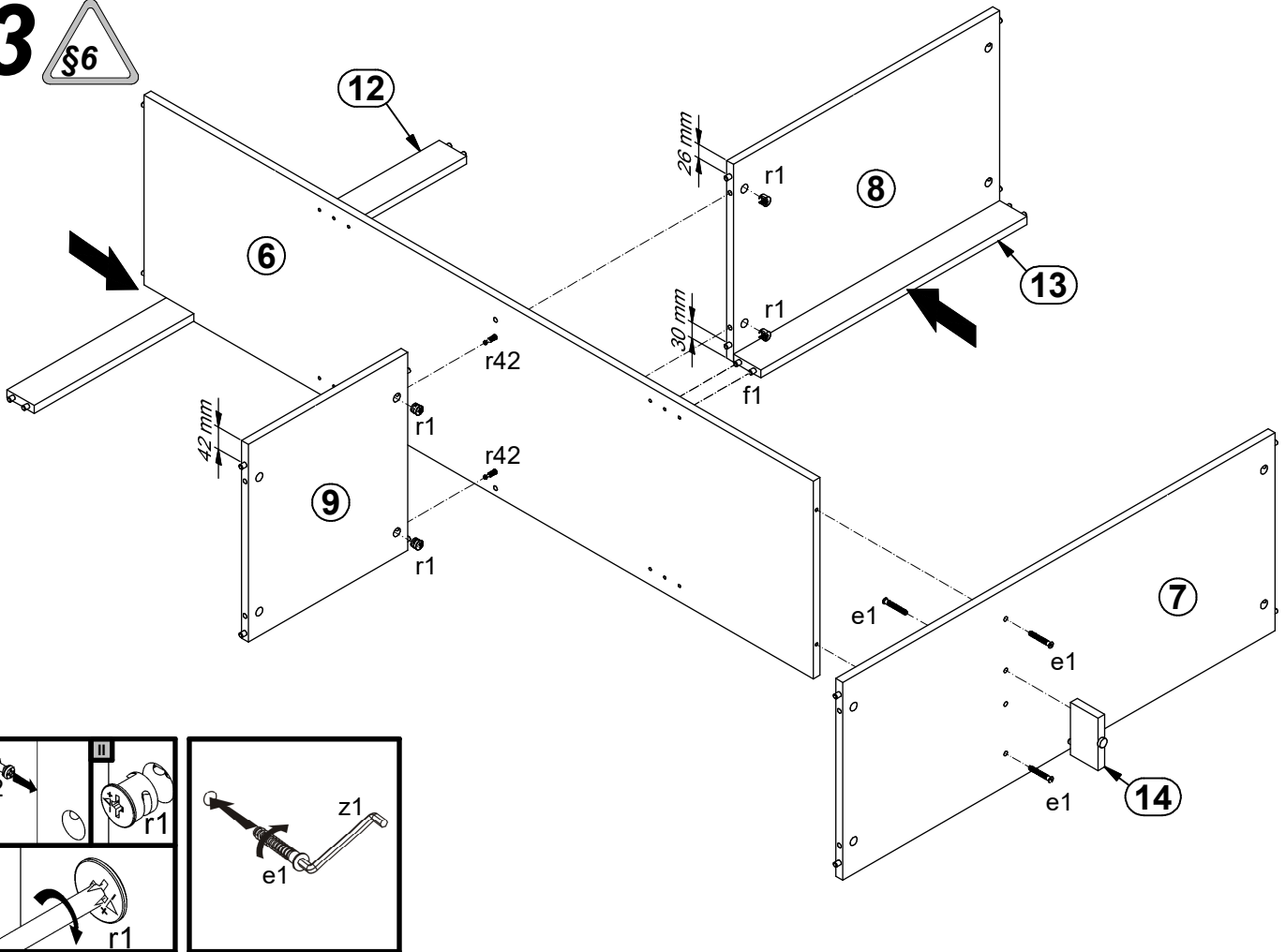

4

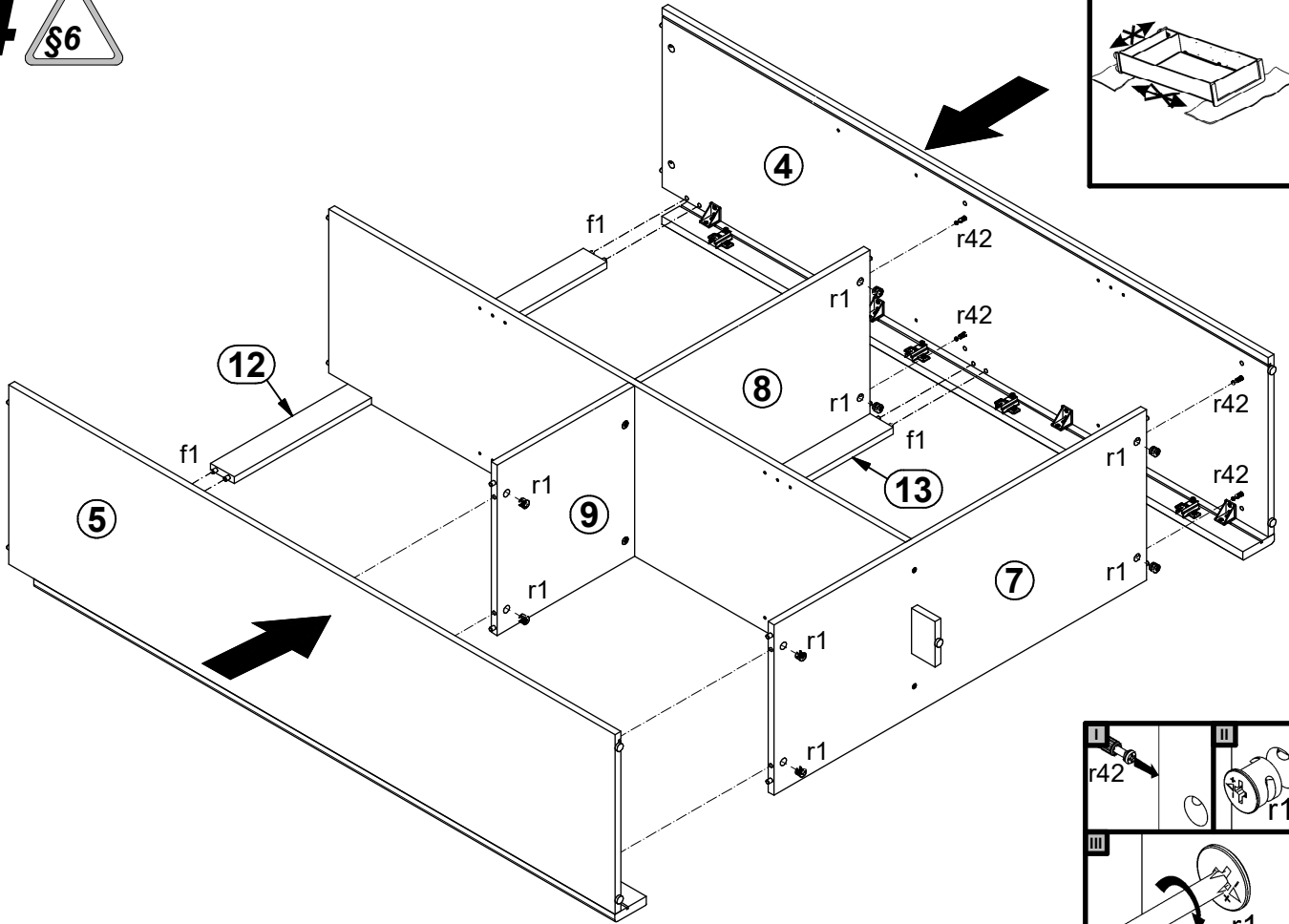
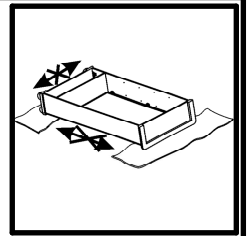

5

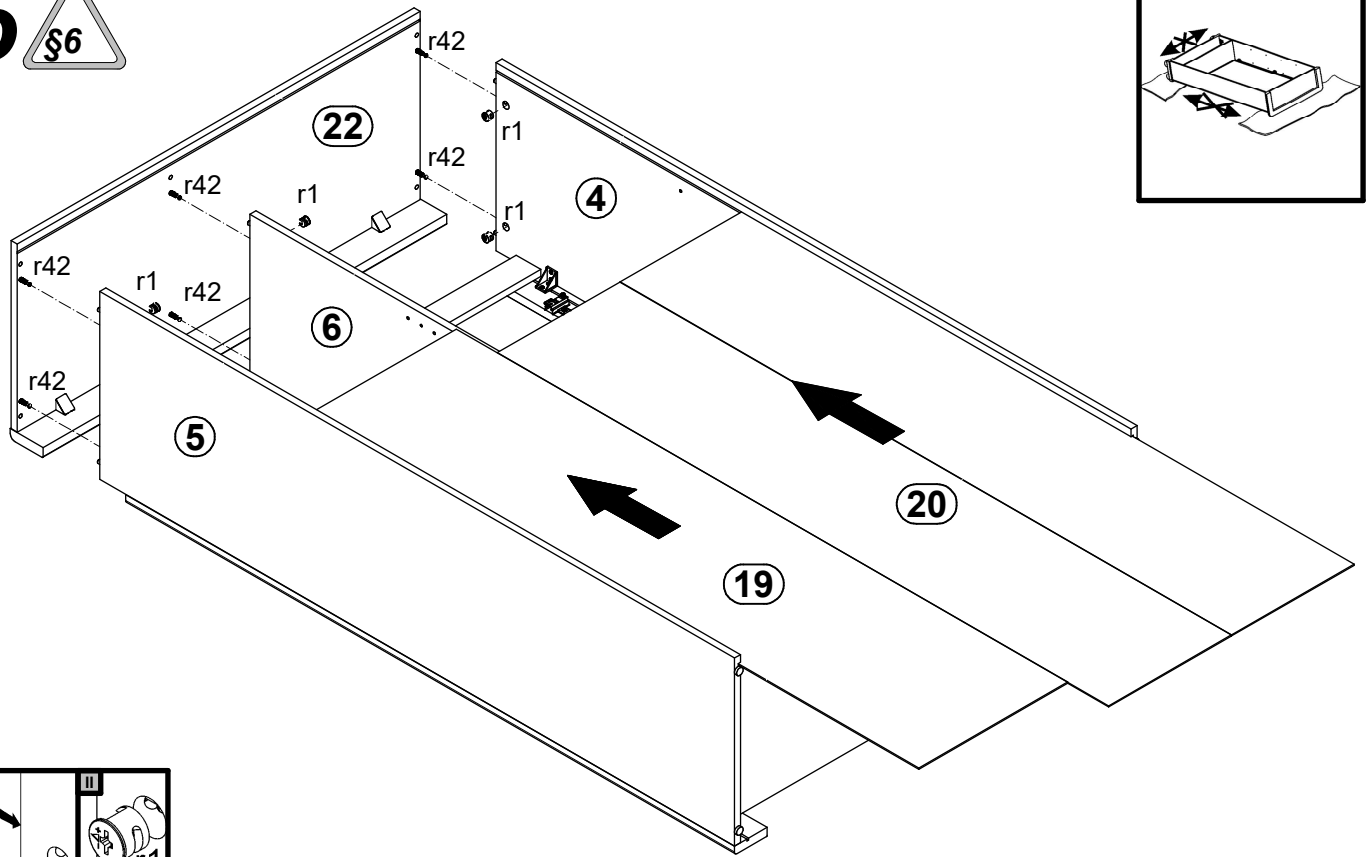
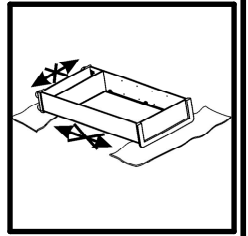

6

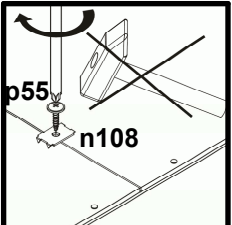
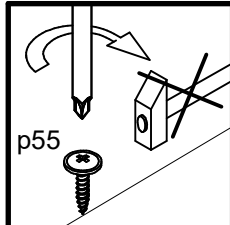
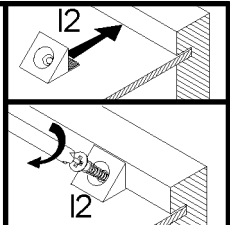
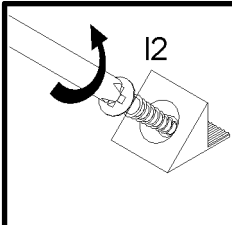
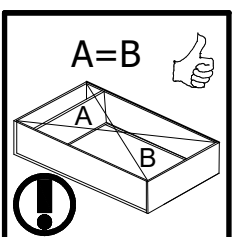
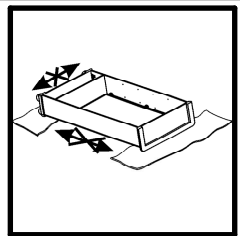
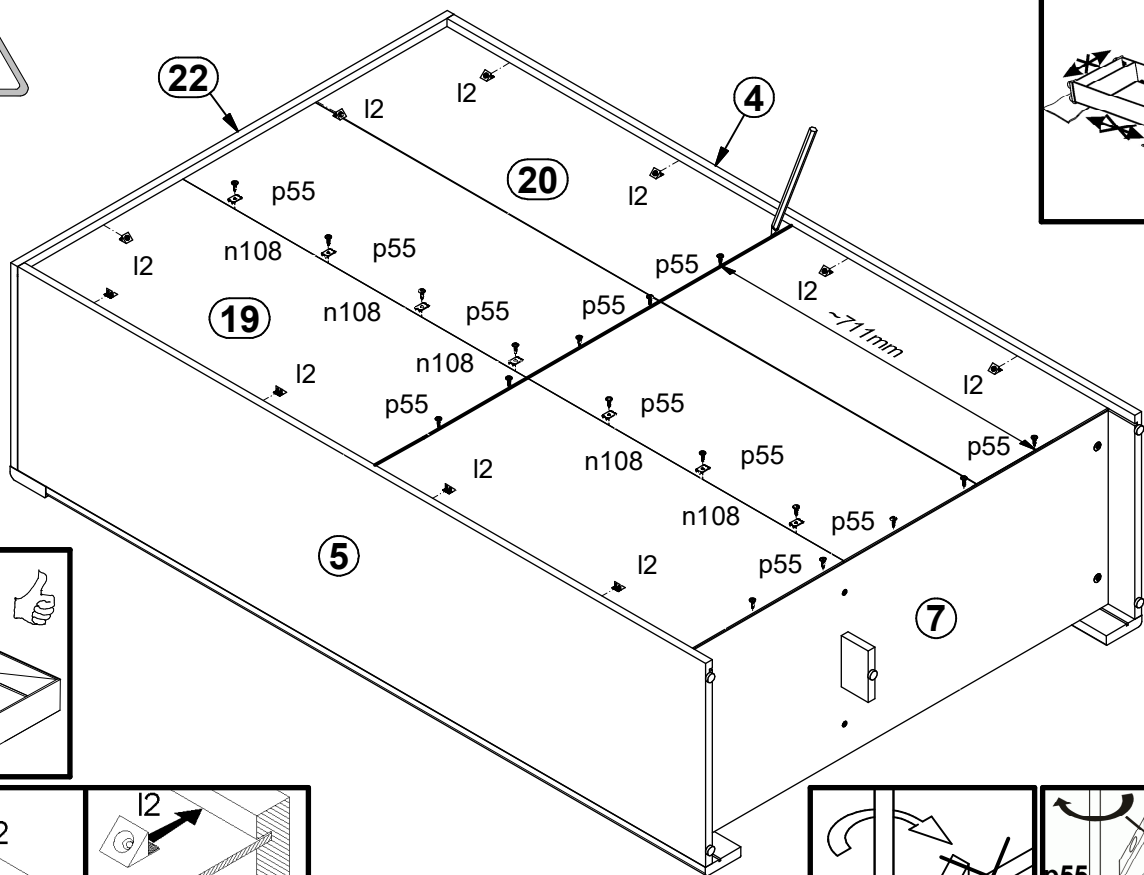

7

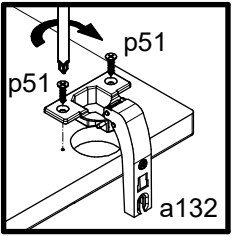
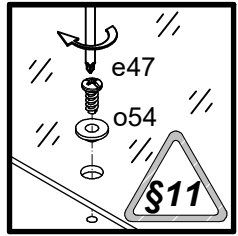
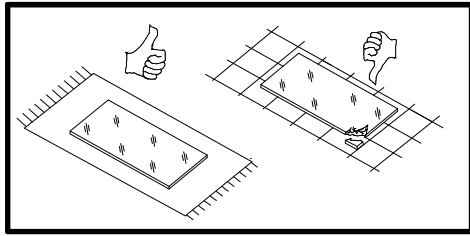
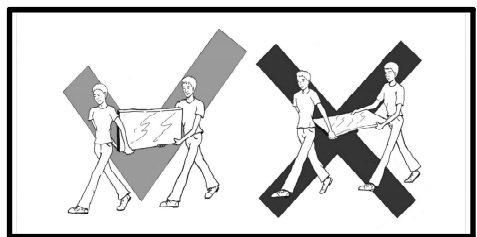
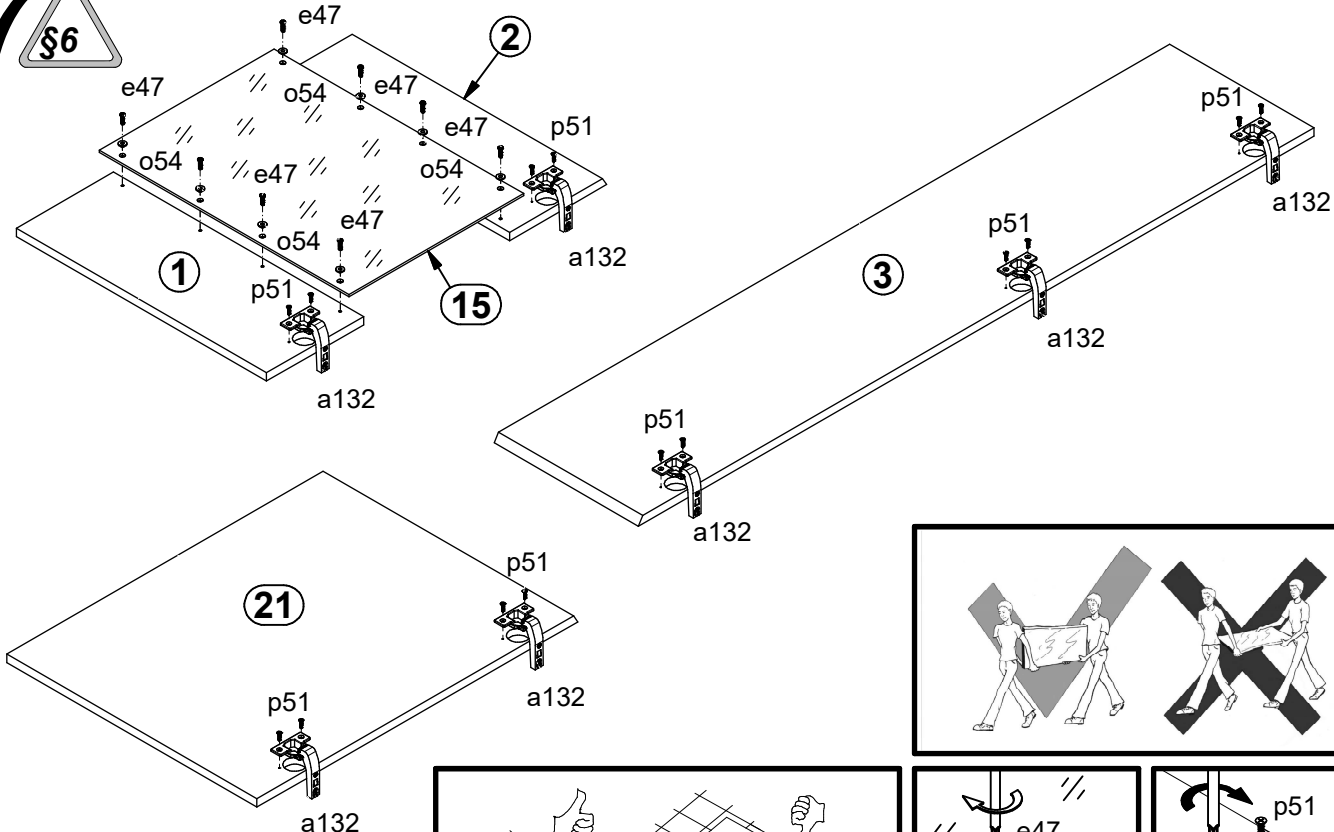

8

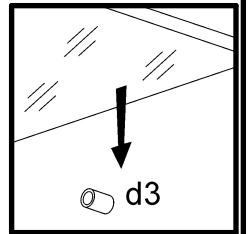
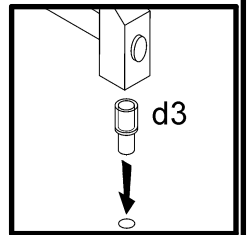
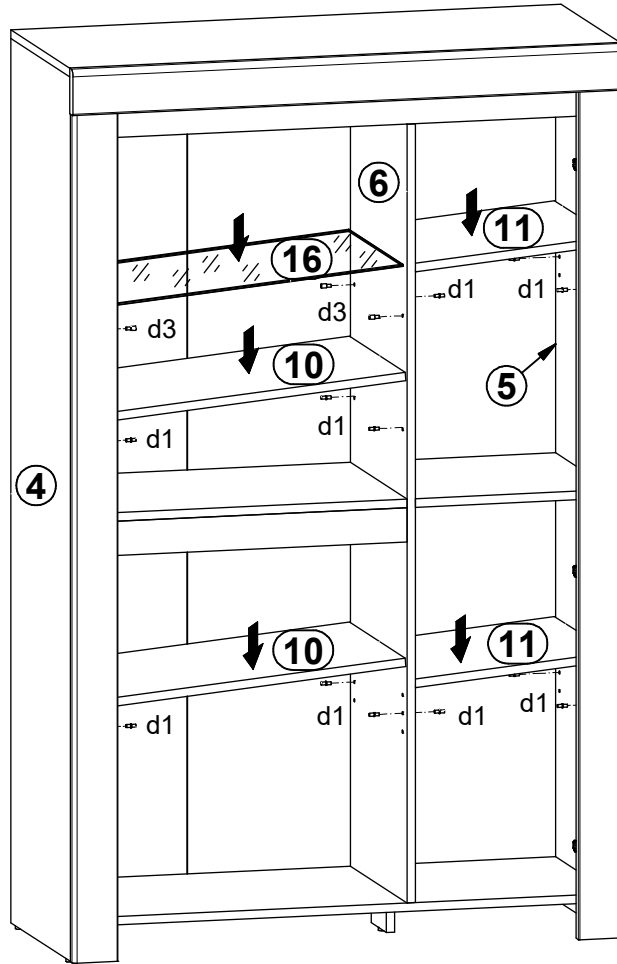
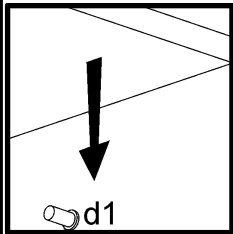
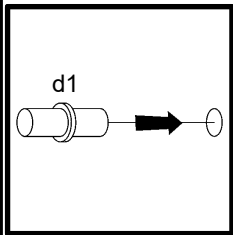
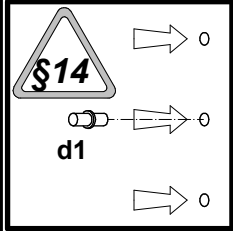

9

