

A

ALAMEDA

S420-WIE

A	B	C	D
1	S420-3050	879	270
2	S420-4068	1500	880

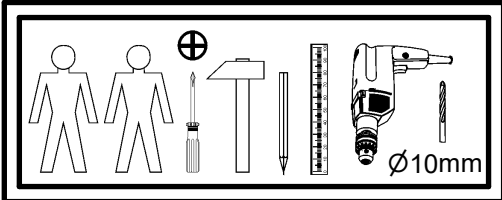
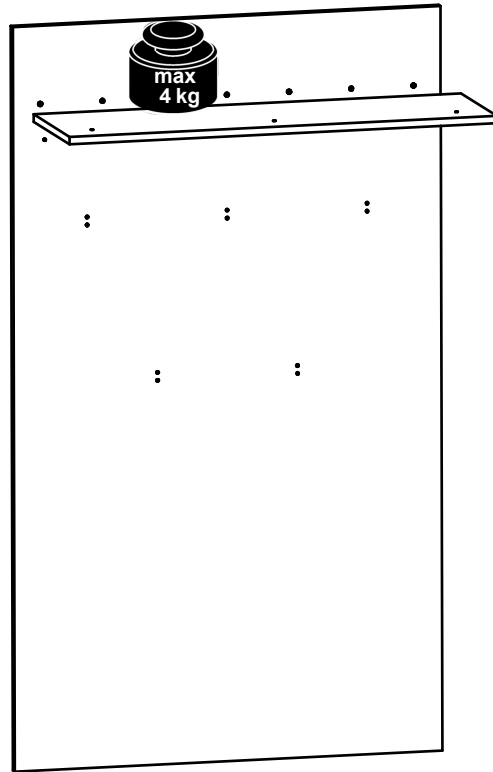
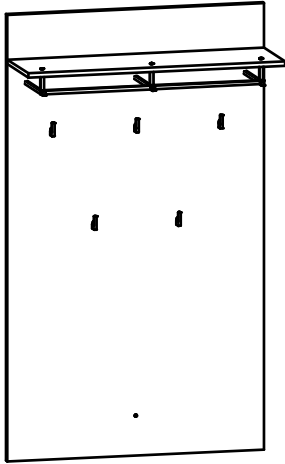

4x Ø7x60 mm e8	4x Ø5x11 mm e4	3x Ø8x30 mm f1	2x Ø10x50 mm f35	1x Ø6x30 mm f50	2x g2	5x g39	2x L=365 mm g41\12	1x g41\4L
1x g41\4P	1x g41\7	16x M4x22 mm j60	1x Ø4x45 mm p62	2x Ø6x60 mm p75	2x silikon s60	1x Ø14x0.5 mm s59	1x z1	

1 §6

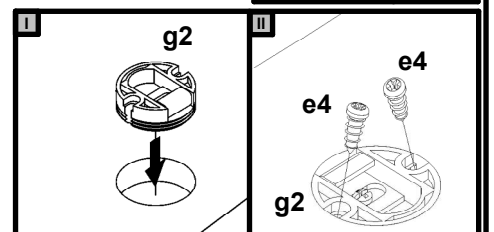
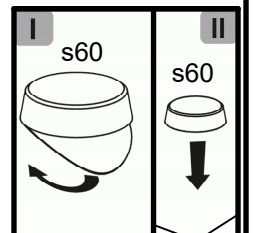
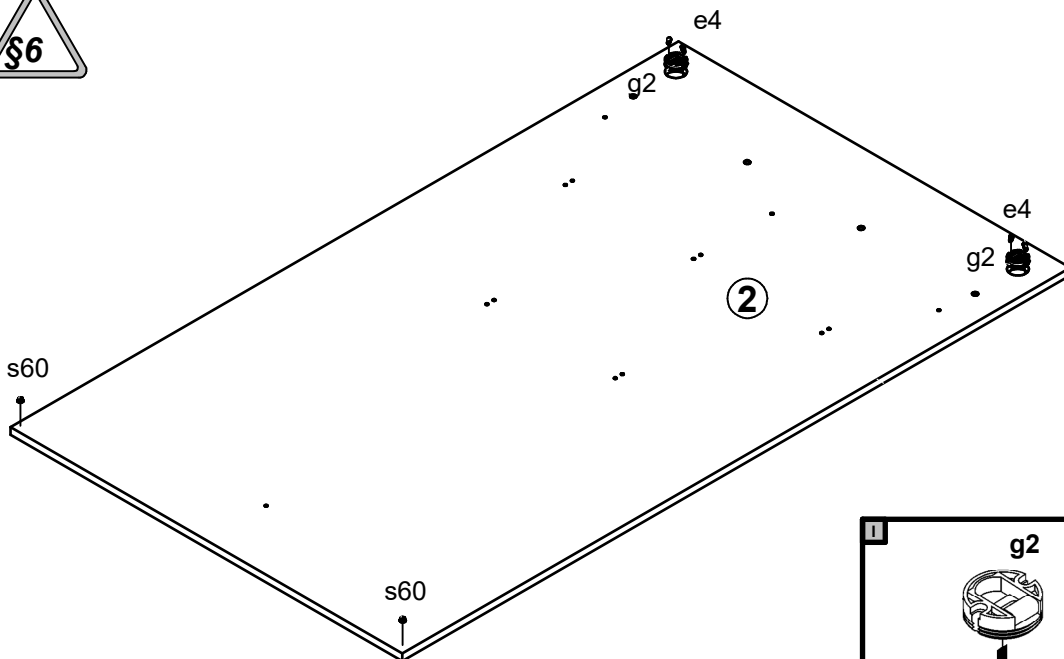

2

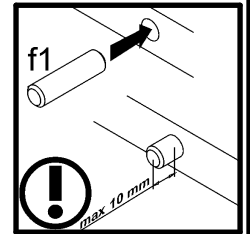
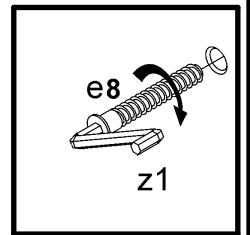
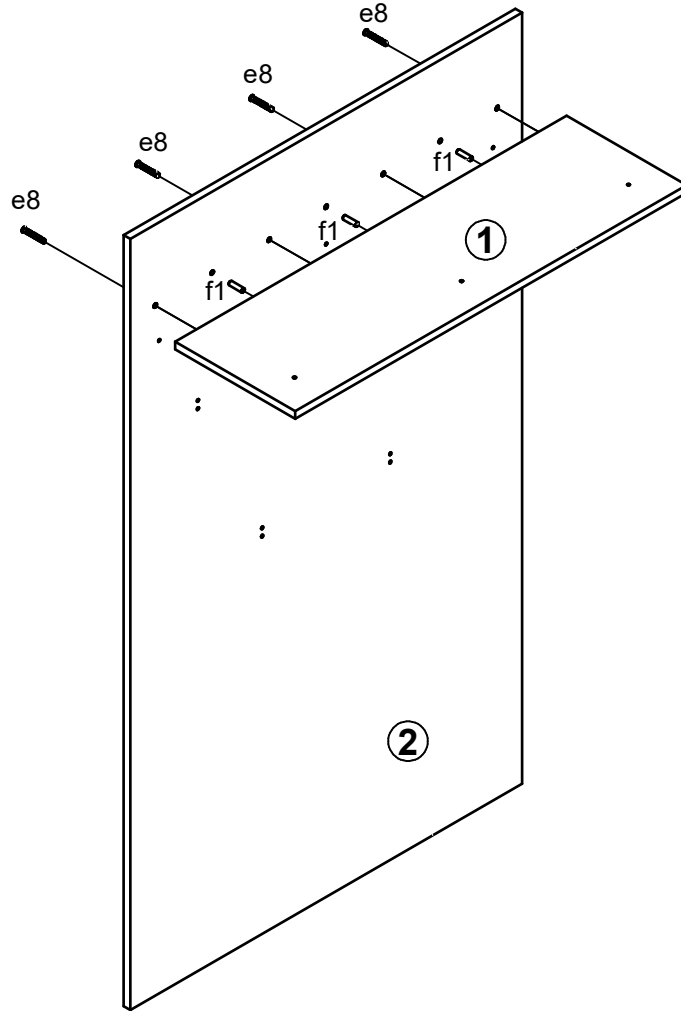

3

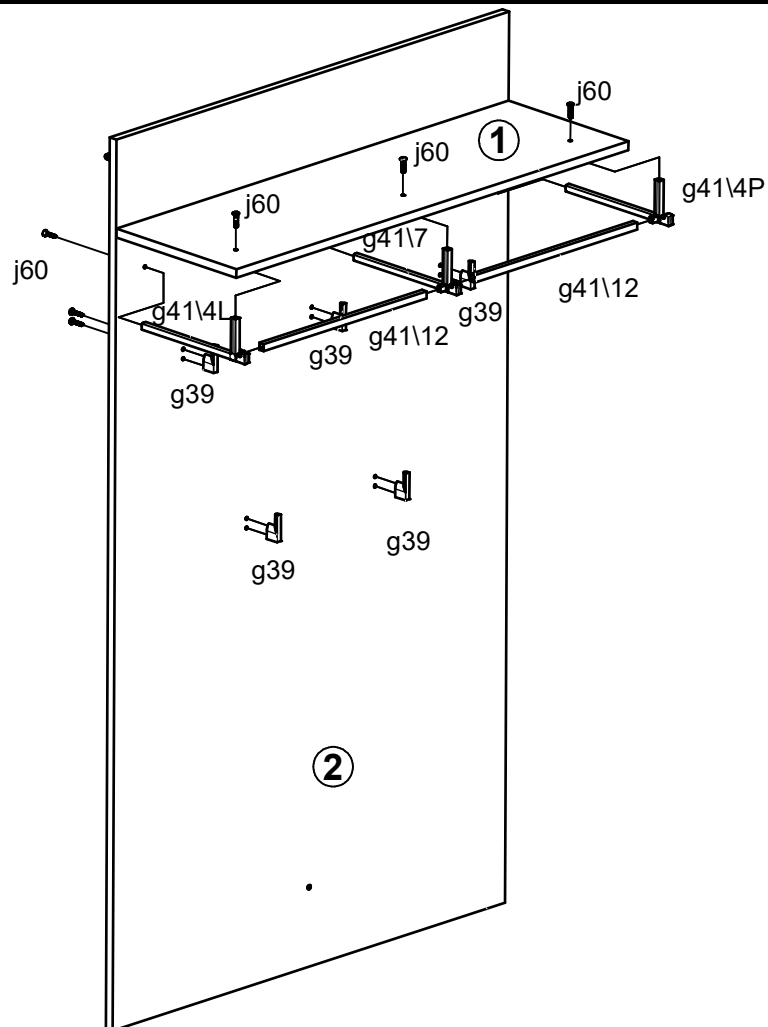

4



φ10 mm

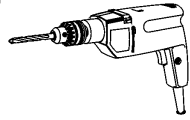

f35

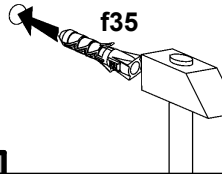

f35

p75

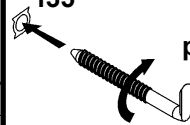

1cm

p75

f35

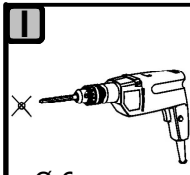
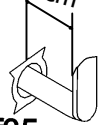

Ø 6 mm



f50

p62

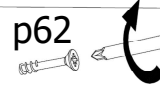

s59

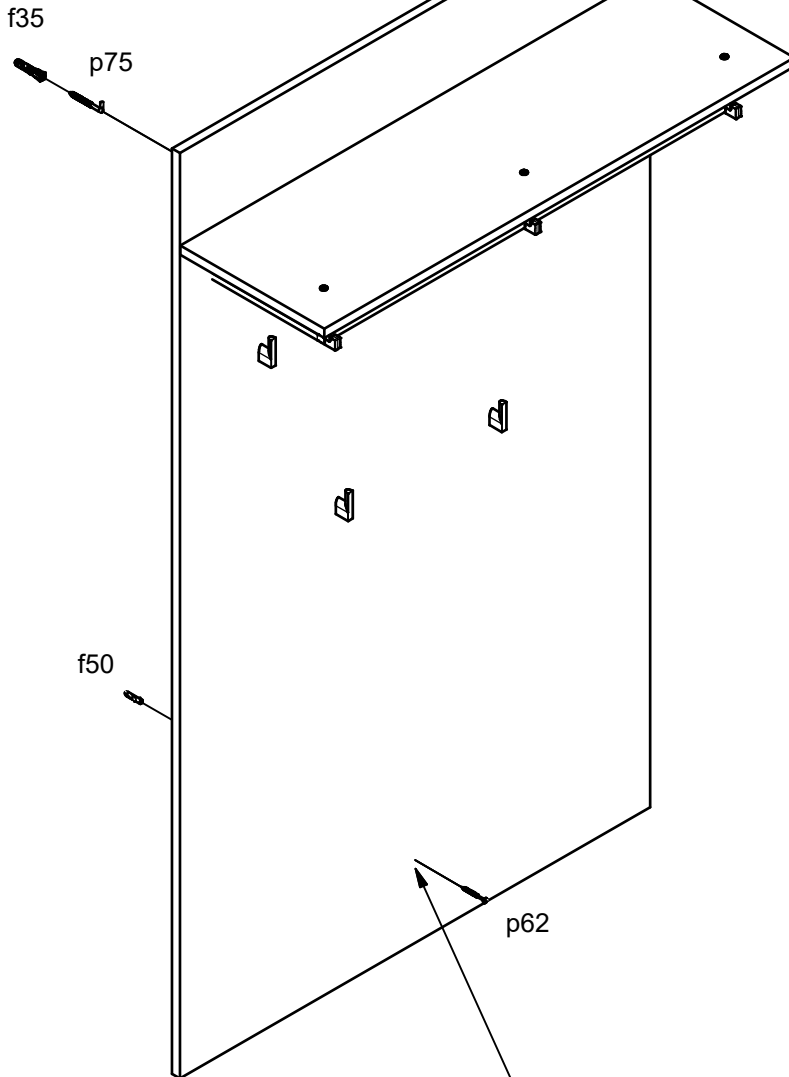
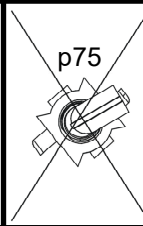
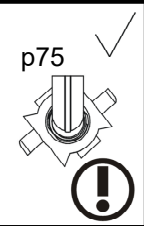
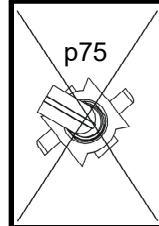
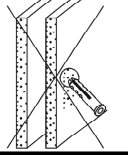
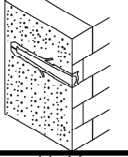
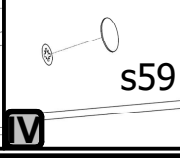

768mm

