

A

LUTON S473-REG1D1W/20/7/L

A	B	C	D	
1	S473-0020	570	516	3/4
2	S473-0021	570	397	3/4
3	S473-0022	570	170	3/4
4	S473-1025	1784	399	1/4
5	S473-1026	1784	399	1/4
6	S473-2011	670	400	2/4
7	S473-2012	670	400	2/4
8	S473-3011	632	346	2/4
9	S473-3013	632	331	2/4
10	S473-3014	633	361	2/4
11	S473-5007	1784	72	1/4
12	S473-5502	748	555	3/4
13	S473-9310	1794	643	1/4

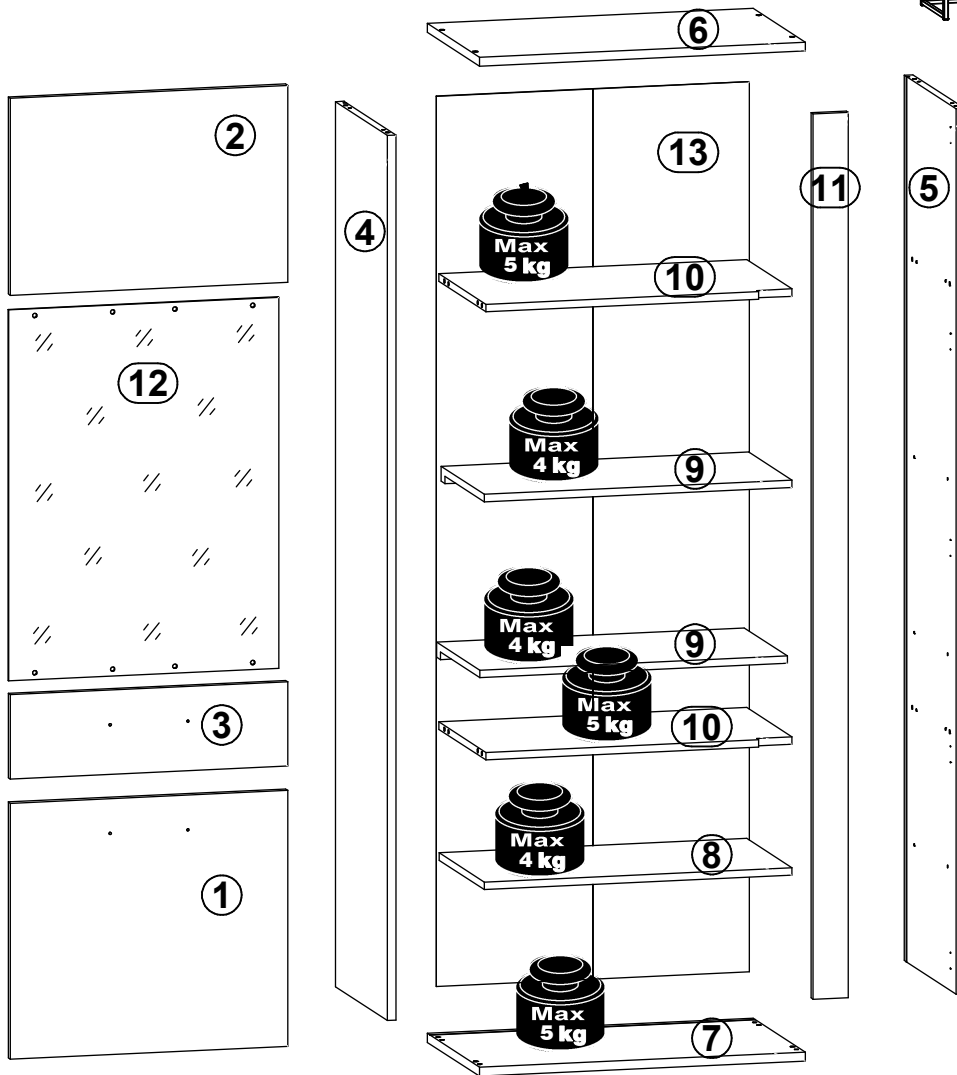
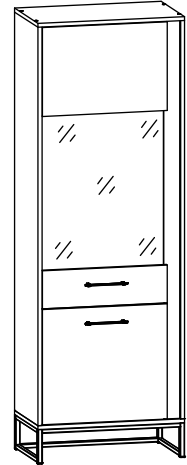
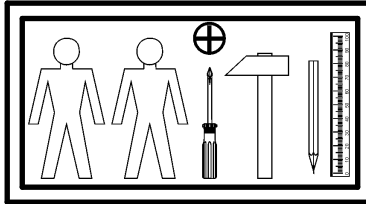

2x hamulec a203	3x a210	5x b90	2x c5361	12x Ø5x17 mm d1	5x d41 2	8x Ø7x50 mm e1	4x Ø6x30 mm e16	8x Ø5x16 mm e47
16x Ø6x30 mm f1	28x M5x12 mm j173	4x M4x22 mm j30	1x k133\52L	1x k133\52P	2x k133\53	1x L-630mm 18x18 k133\54	2x L-630mm 18x18 k133\55	2x L-360mm 18x18 k133\56
2x L-360mm 18x18 k133\57	12x l2	8x Ø5,3\Ø8,3x4,8 mm o54	6x o77\16	2x 10x10 mm L=590 mm o77\50	6x Ø2,5x13 mm p15	21x Ø3,5x16 mm p38	10x Ø3,5x15 mm p51	4x Ø2,9x16 mm p55
8x Ø15x12 mm #16 r1	8x 20/11 r42	4x Ø 20mm s68	1x Zasilacz 6W 12V z okablowaniem 4m, wyłącznik nożny, rozdzielacz 3 punkty o70	1x 4 mm z1	1x 3 mm z22	1x n26\1		

1 §2

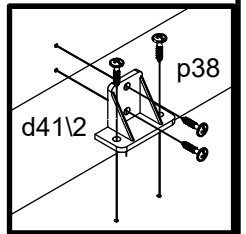
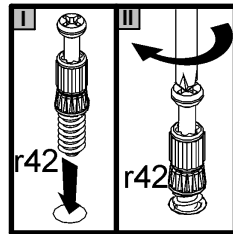
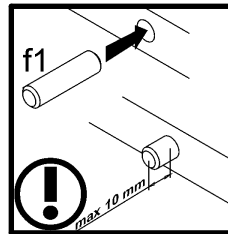
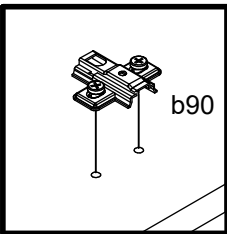
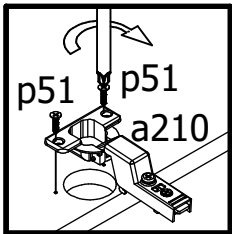
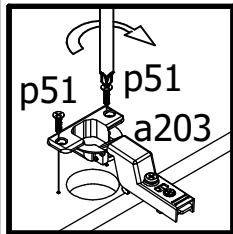
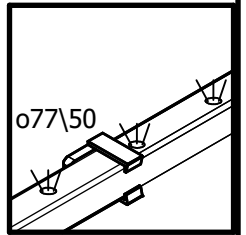
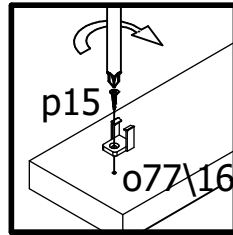
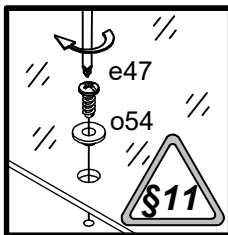
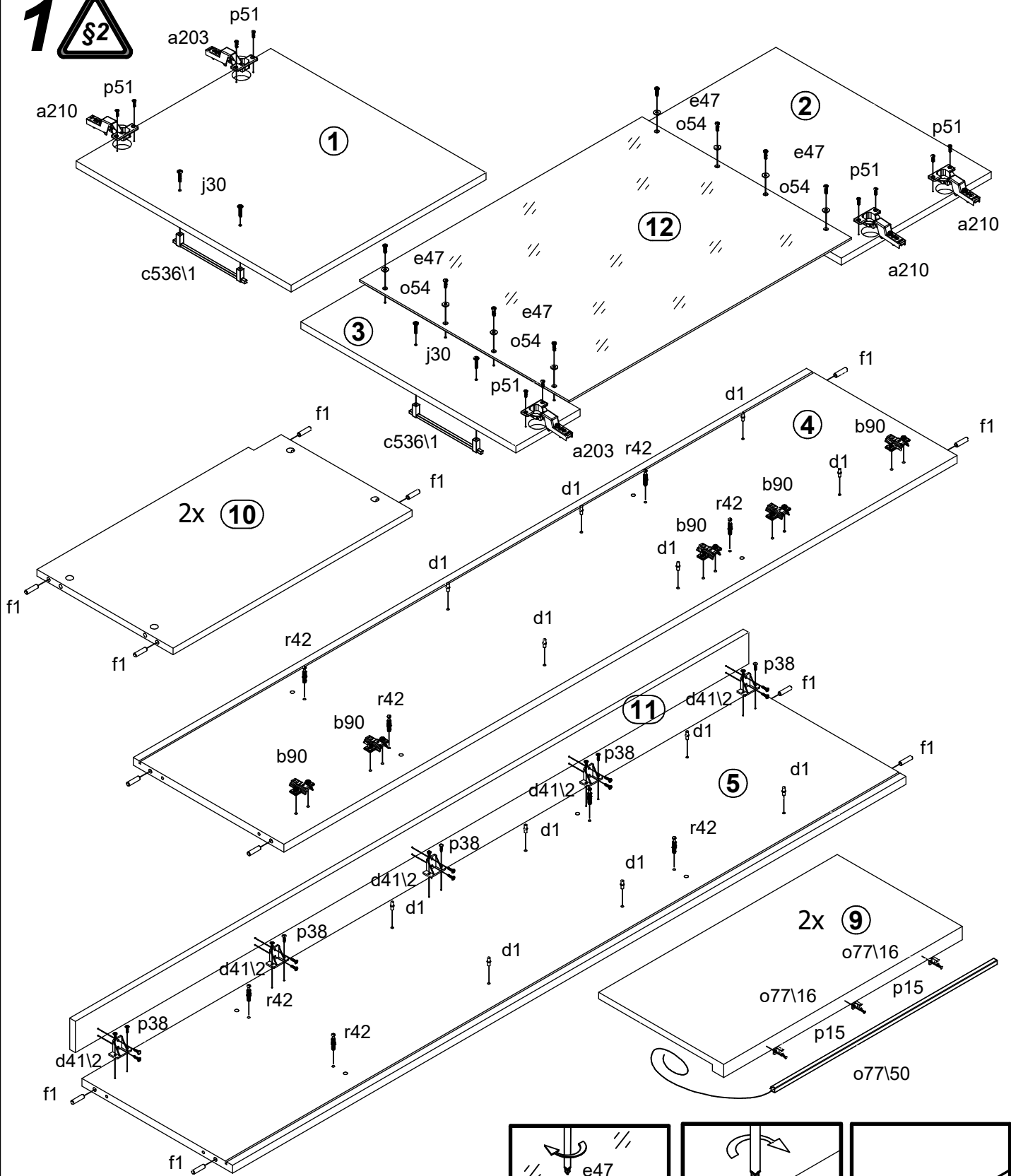

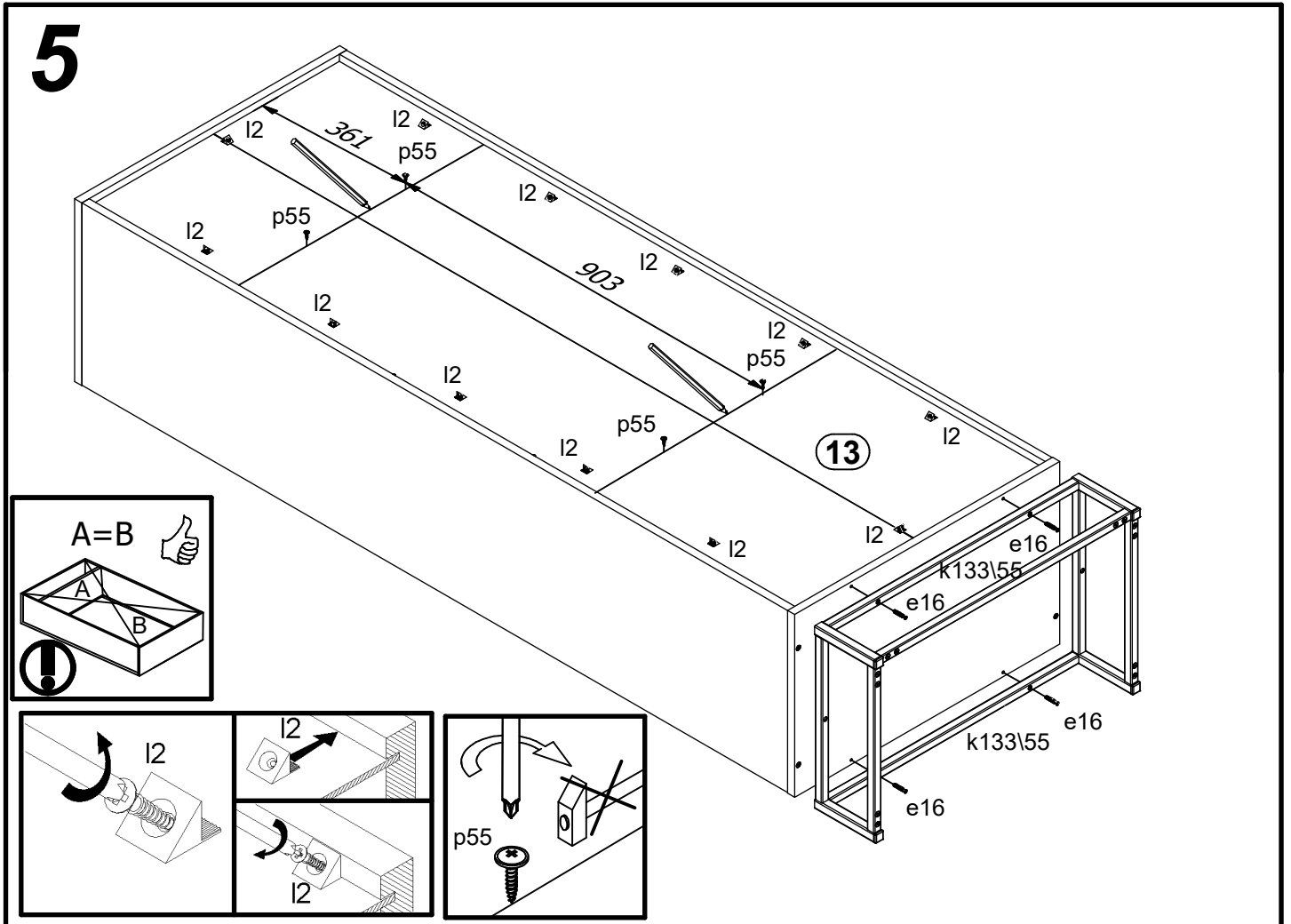
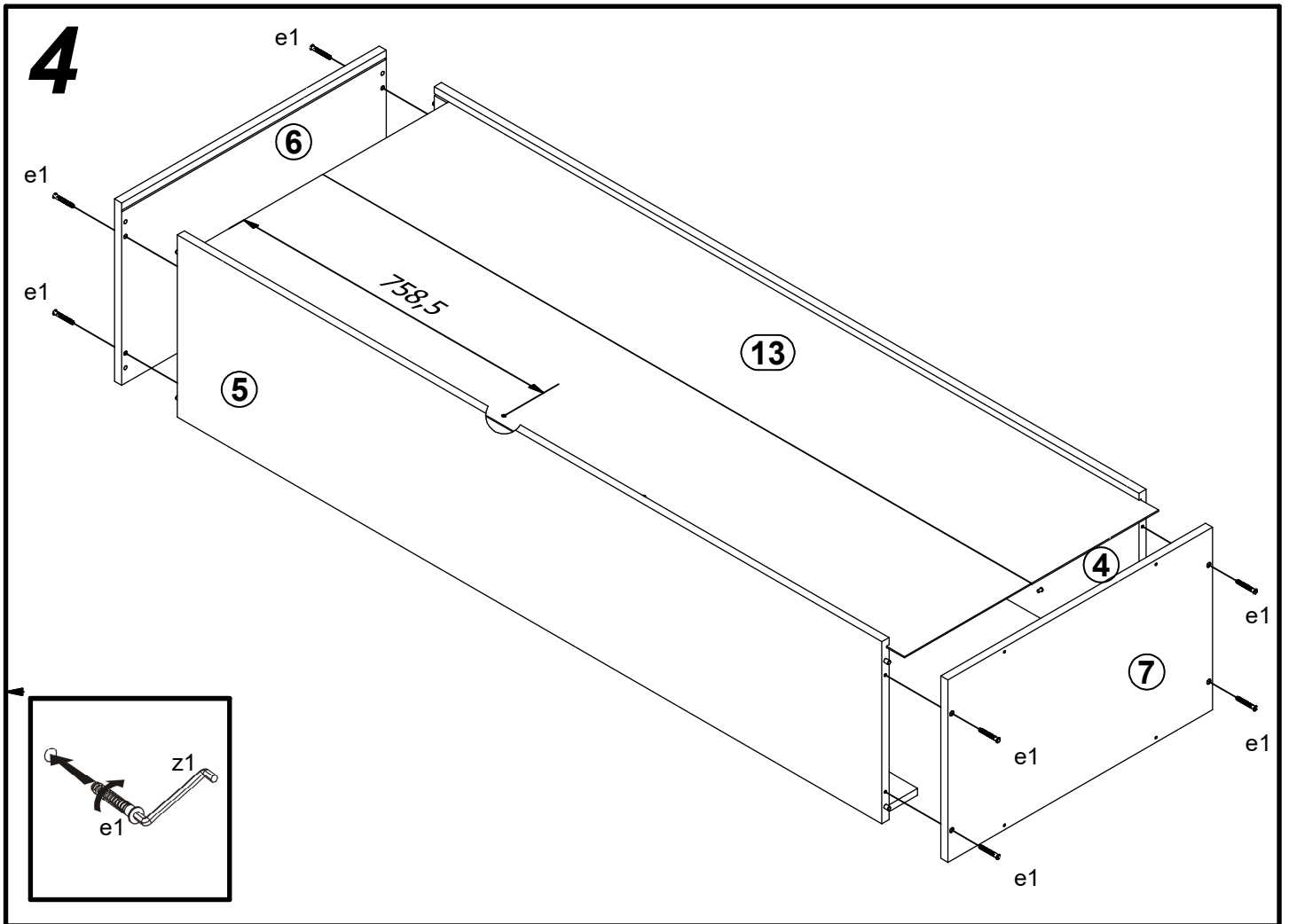

6

