

A	B	C	D
1	L112-0001	496	180
2	L112-1001	187	364
3	L112-1002	187	364
4	L112-1003	166	250
5	L112-2001	500	380
6	L112-2002	500	380
7	L112-3001	501	402
8	L112-4001	500	639
9	L112-9001	429	357
10	ZK3-5092	419	127
11	ZK4-513	350	140
12	ZK4-514	350	140

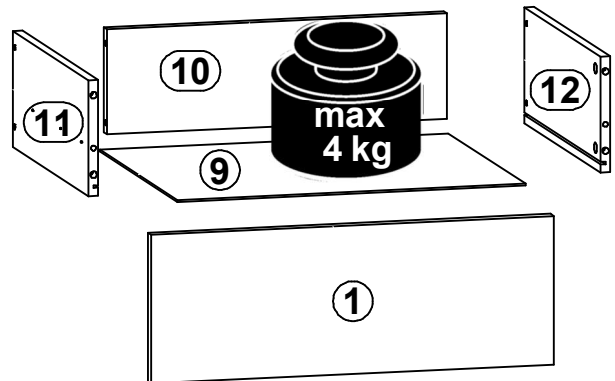

1x L=84mm c537\1	17x Ø7x50 mm e1	8x Ø8x30 mm f1	2x Ø6x30 mm f9	4x Ø6.5x40 mm f25	4x Ø20x3mm k103	1x Ø70\11	2x Ø43\7	3x Ø77\16
1x L=405 mm Ø77\56	1x Ø127\2	1x Ø107\6	2x Ø3.5x13 mm p1	3x Ø2.5x13 mm p15	3x Ø3.5x16 mm p38	12x Ø3.5x12 mm p140	4x Ø15x12 mm #16 r1	4x Ø12x10.5 mm #12 r15
8x 20/11 r42	2x L=300mm w210\1	2x L=350 mm w210\2	1x 4 mm z1					

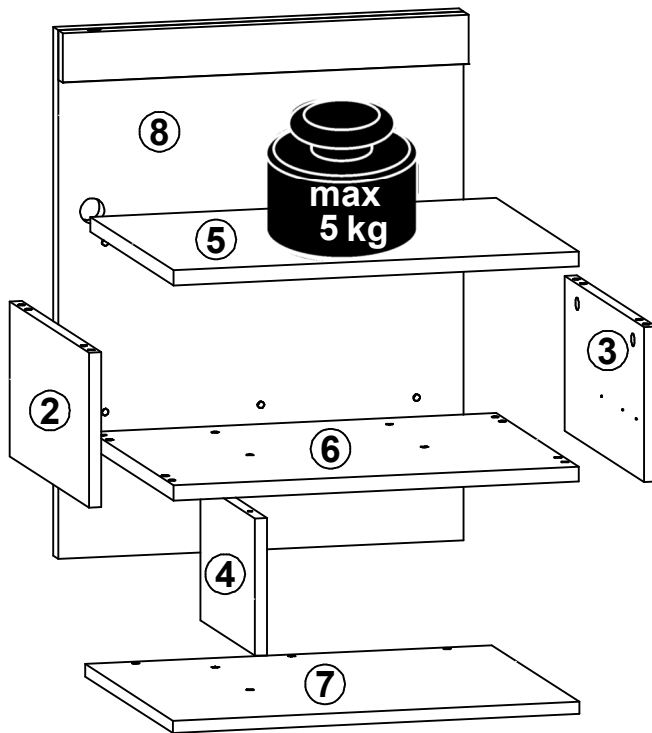
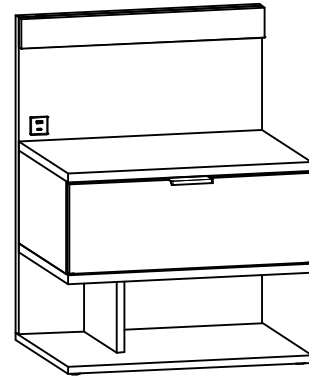
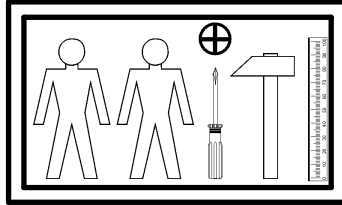
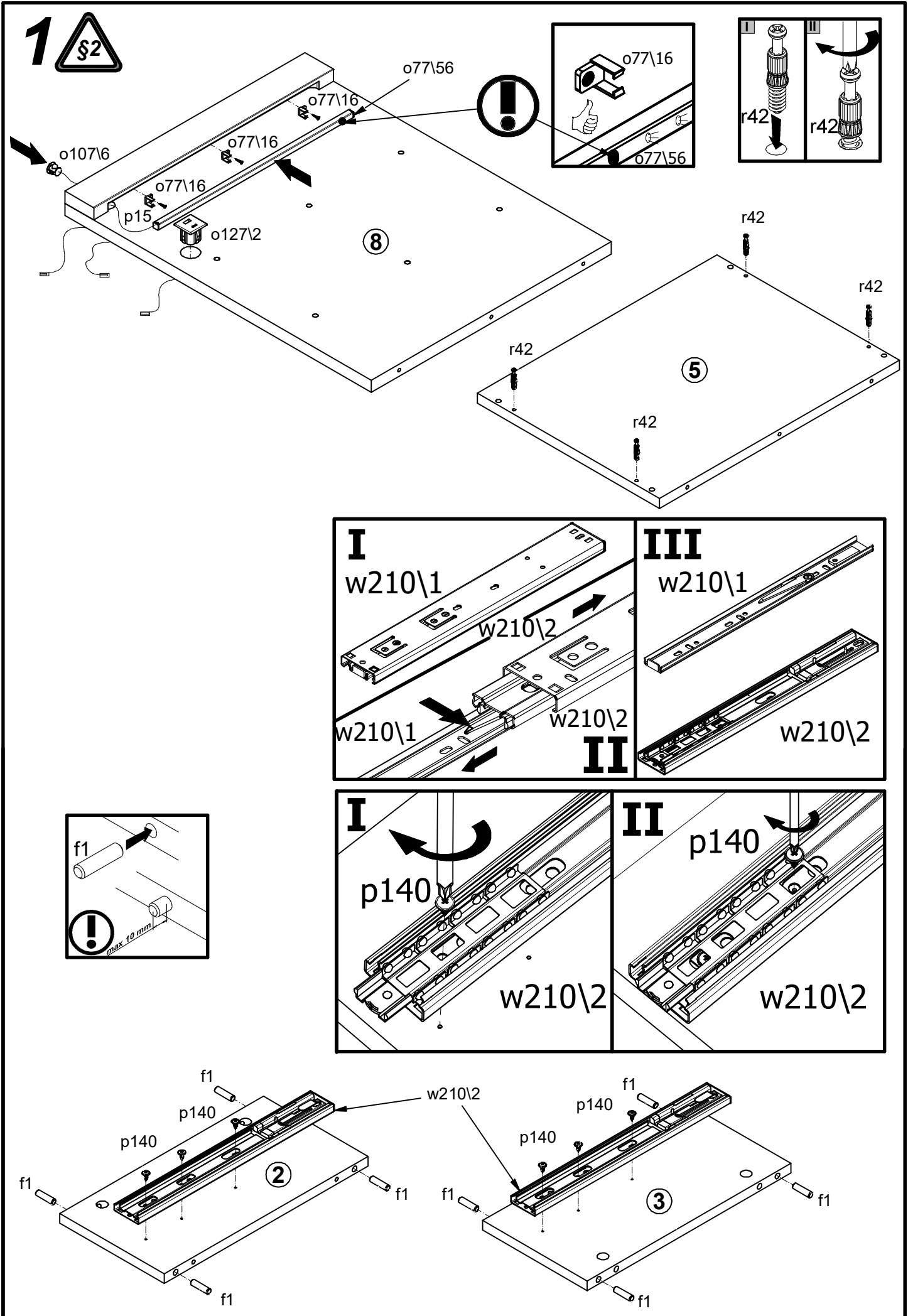

1 

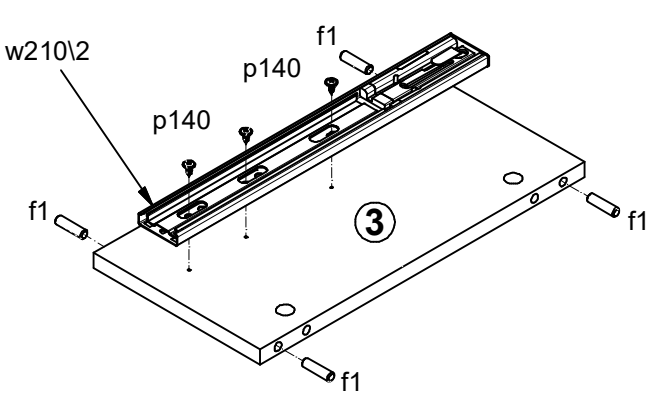
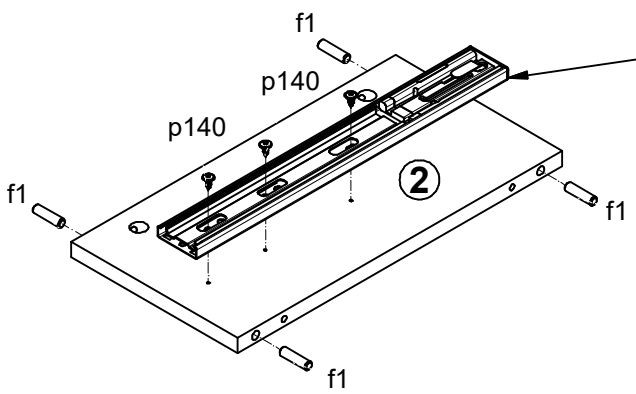
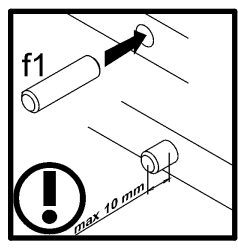
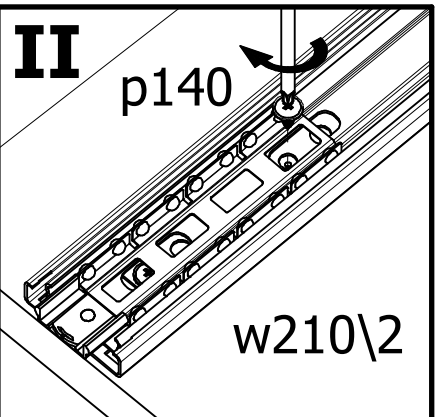
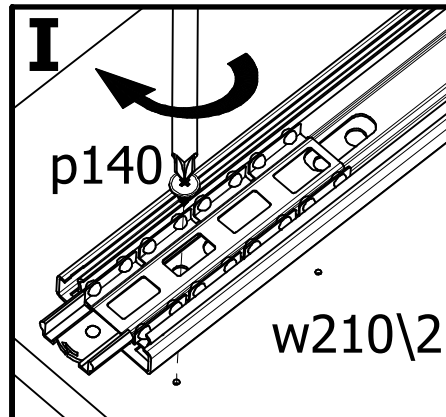
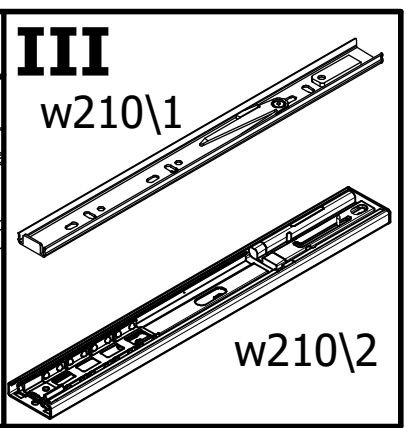
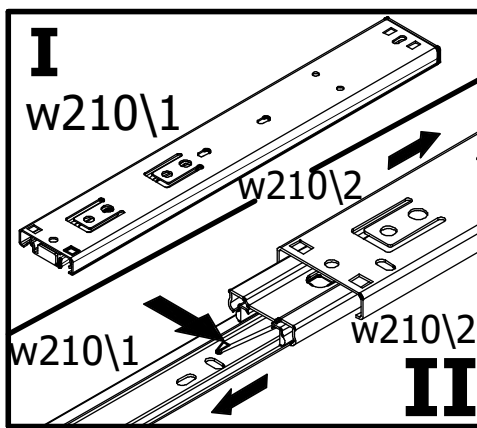
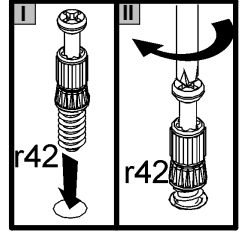
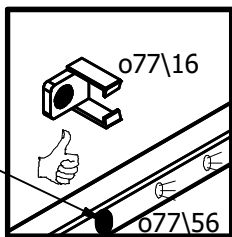

2 

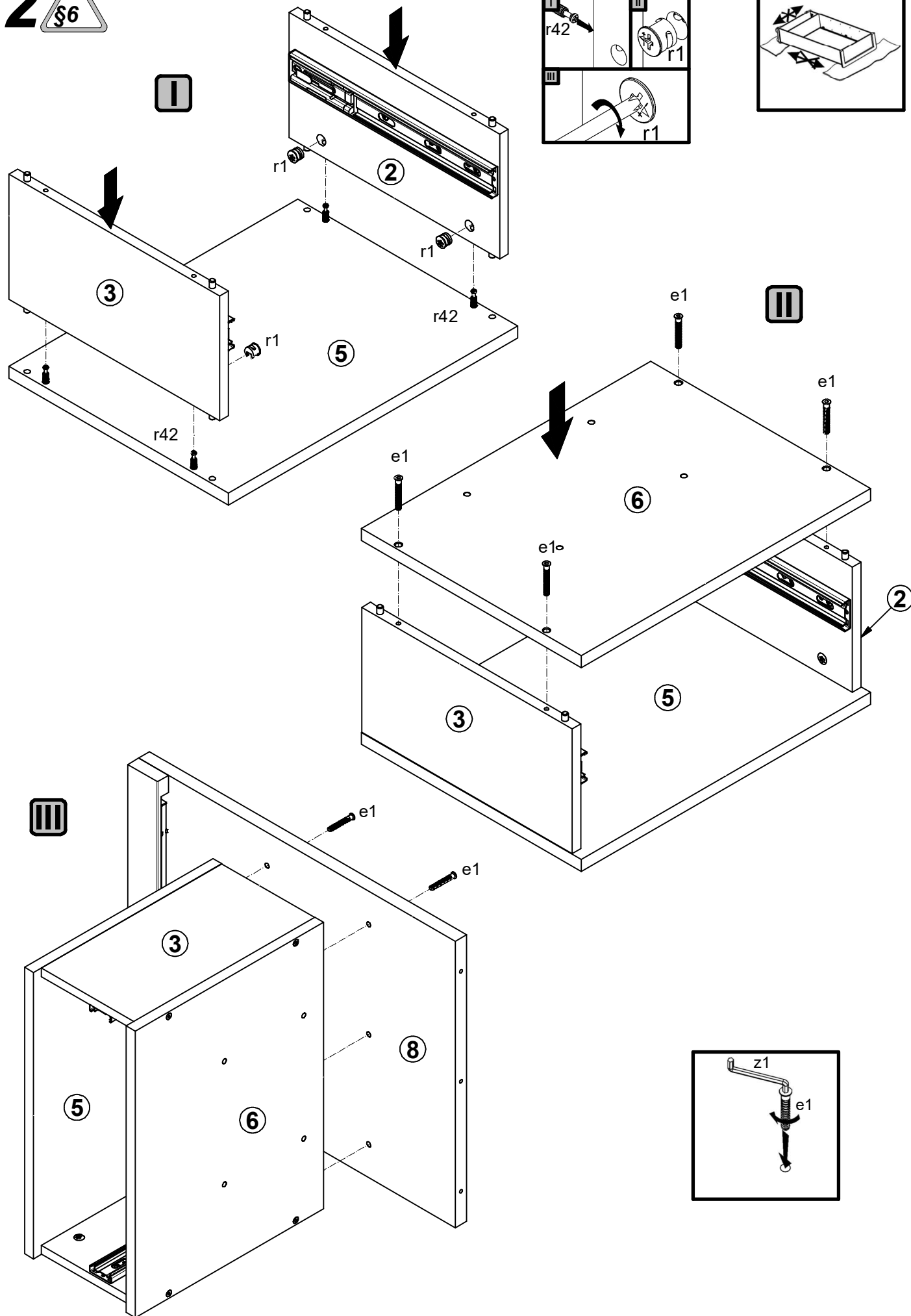

3 §6

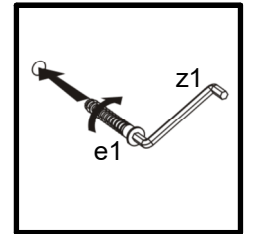
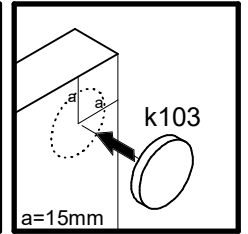
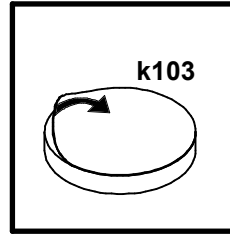
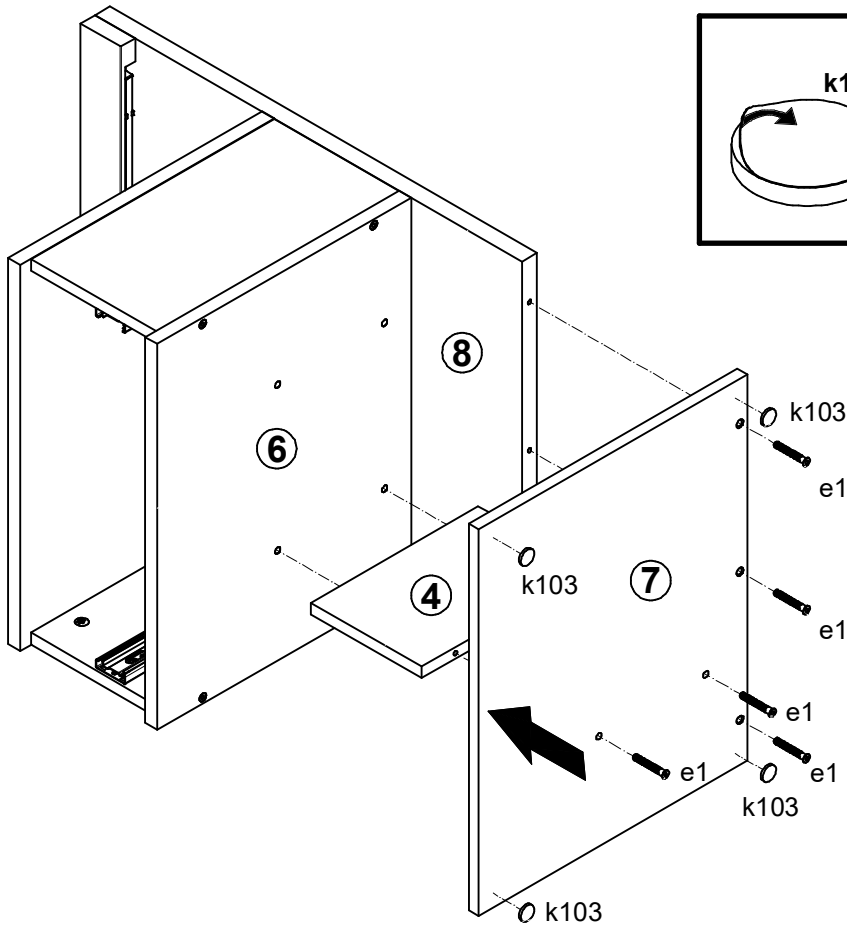

4 §2 §6

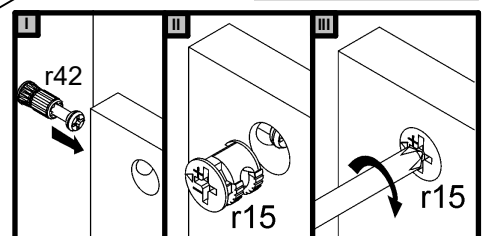
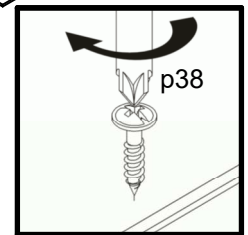
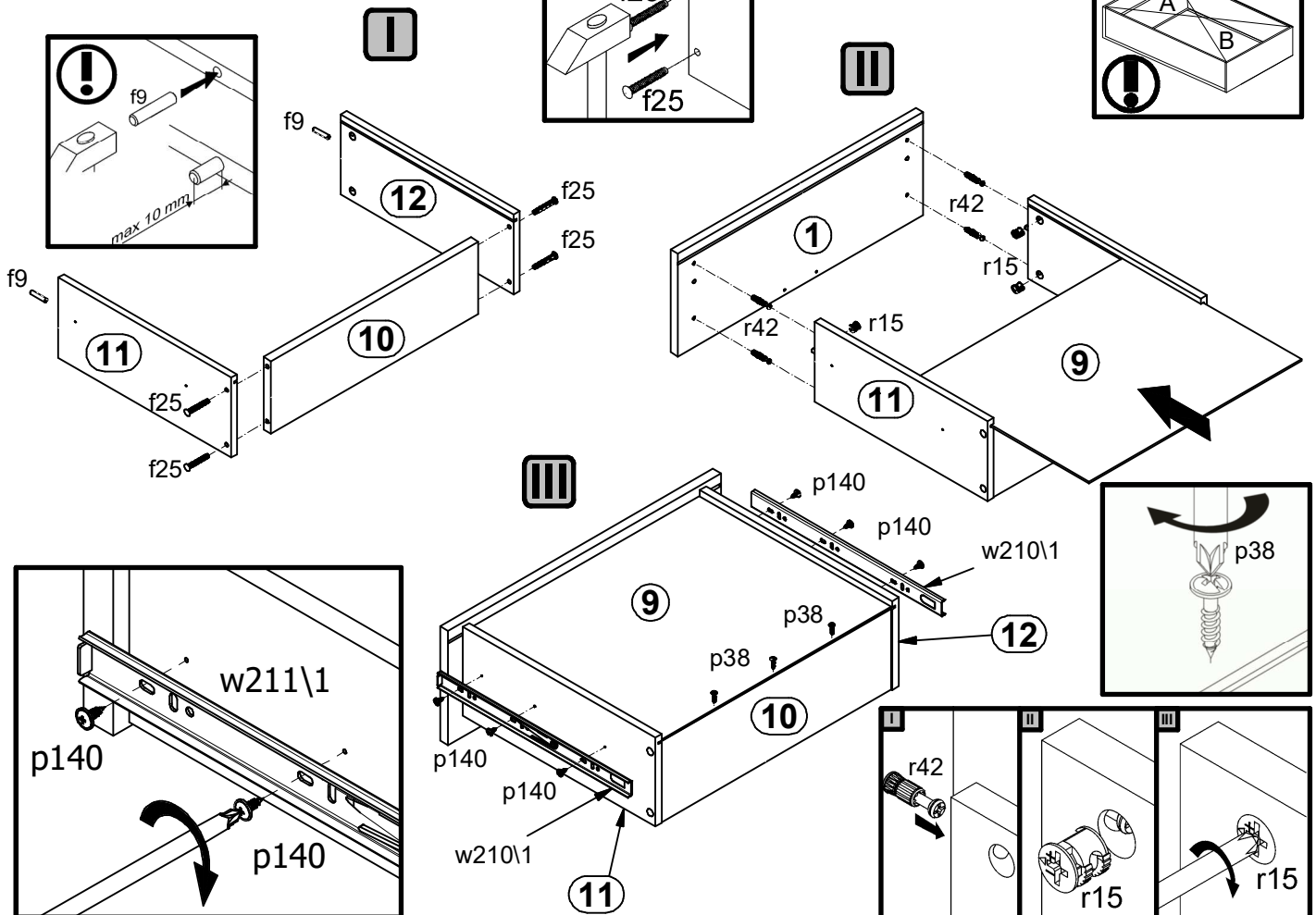
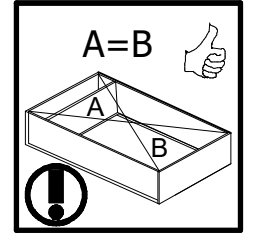
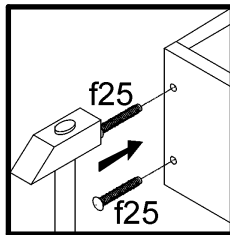

5

