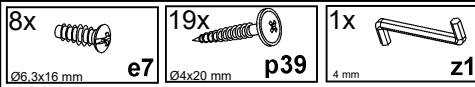
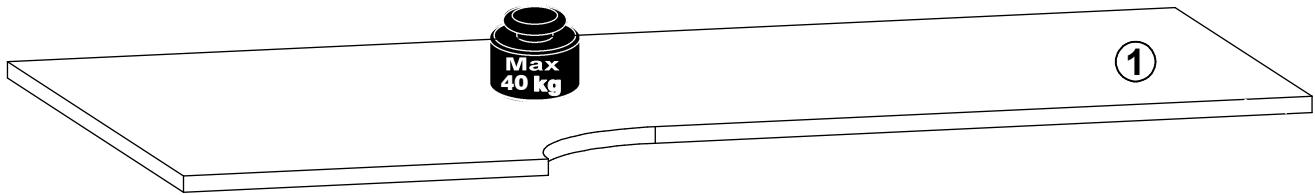
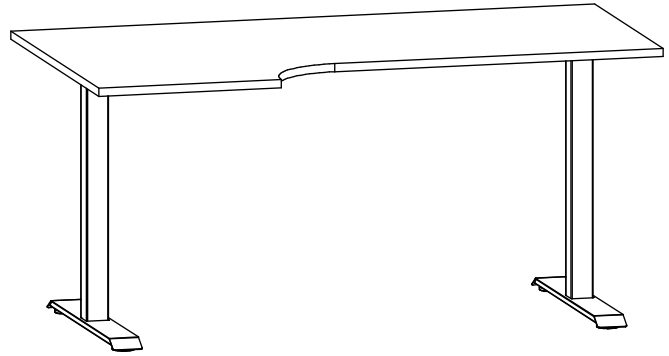
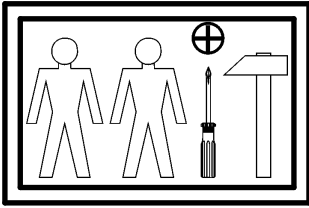
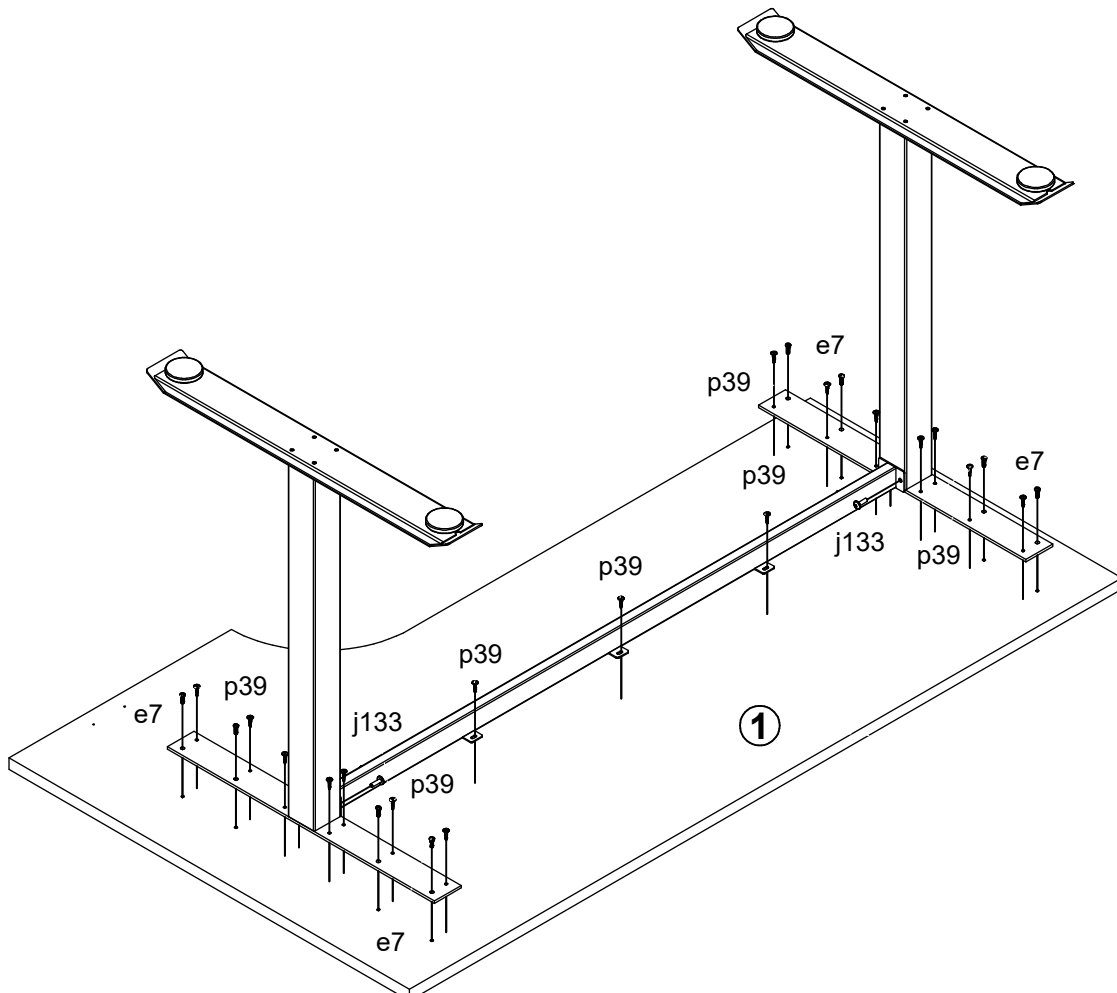

**A****OFFICE SPACE****S479-BIU/160/90/A/L**

A	B	C	D
1	S479-2018	1600	900 1/3

**1**

**A****OFFICE SPACE****S479-BIU/160/90/B/L**

A	B	C	D
1	S479-2018	1600	900 1/2

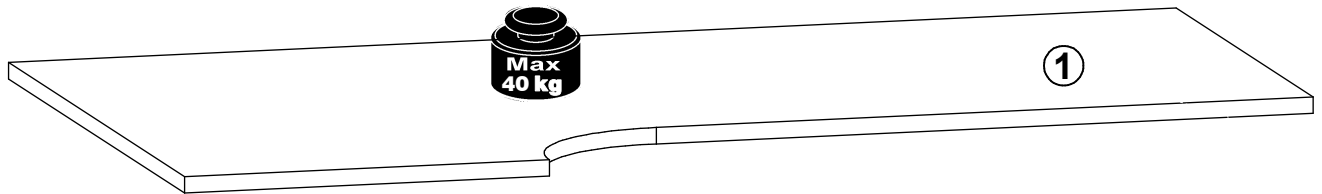
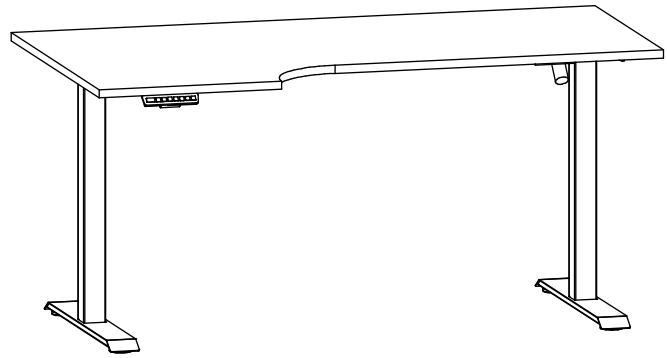
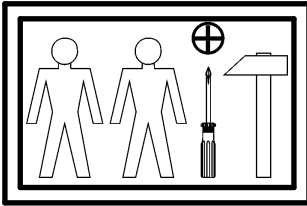

8x Ø6.3x16 mm e7	4x Ø4x20 mm p39	2x Ø4x16 mm p131
------------------------	-----------------------	------------------------

**1**