

A	B	C	D
1	S488-0004	758	509
2	S488-1009	2014	399
3	S488-1010	2014	399
4	S488-2003	674	399
5	S488-3006	643	379
6	S488-3007	642	373
7	S488-3008	643	379
8	S488-5507	643	75
9	S488-5508	676	80
10	S488-5509	1950	80
11	S488-5511	1950	80
12	S488-9307	2016	653

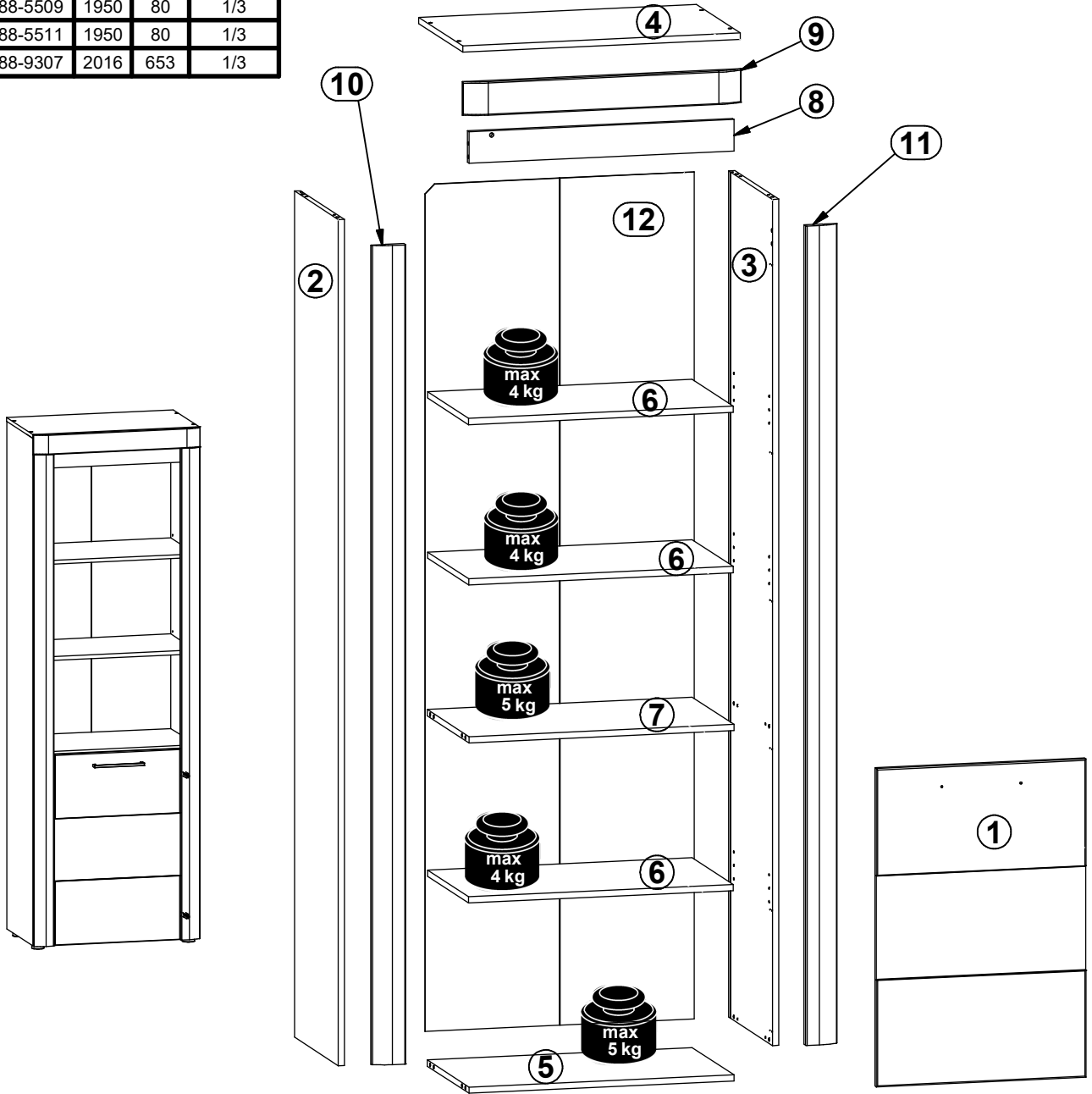

2x a132	1x a133	2x b43	1x c342/3	12x d1	3x d36	12x d37	4x e1	4x e2
16x f1	2x j30	4x k27	11x l2	1x o70/9	2x o77/16	1x o77/61	2x o83/9	2x p15
54x p38	4x p51	8x p55	8x r1	8x r42	1x z1	1x n14/2	1x f35	1x p17
2x p38								

1 

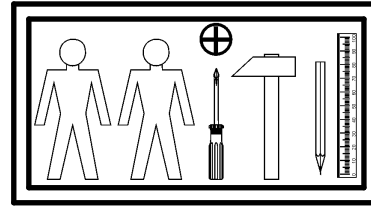
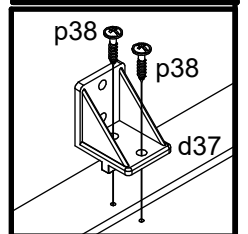
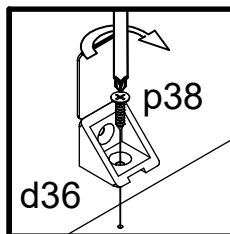
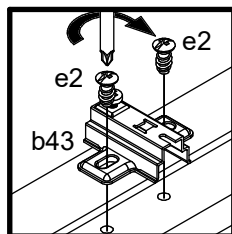
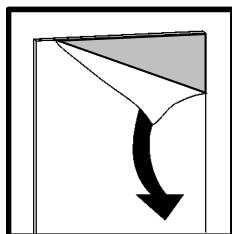
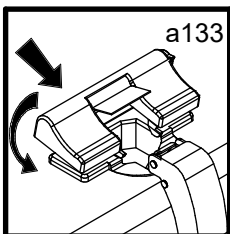
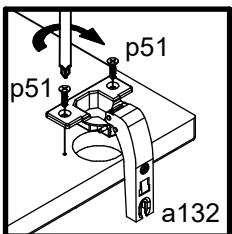
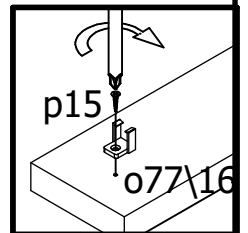
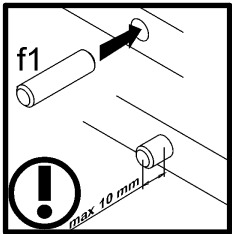
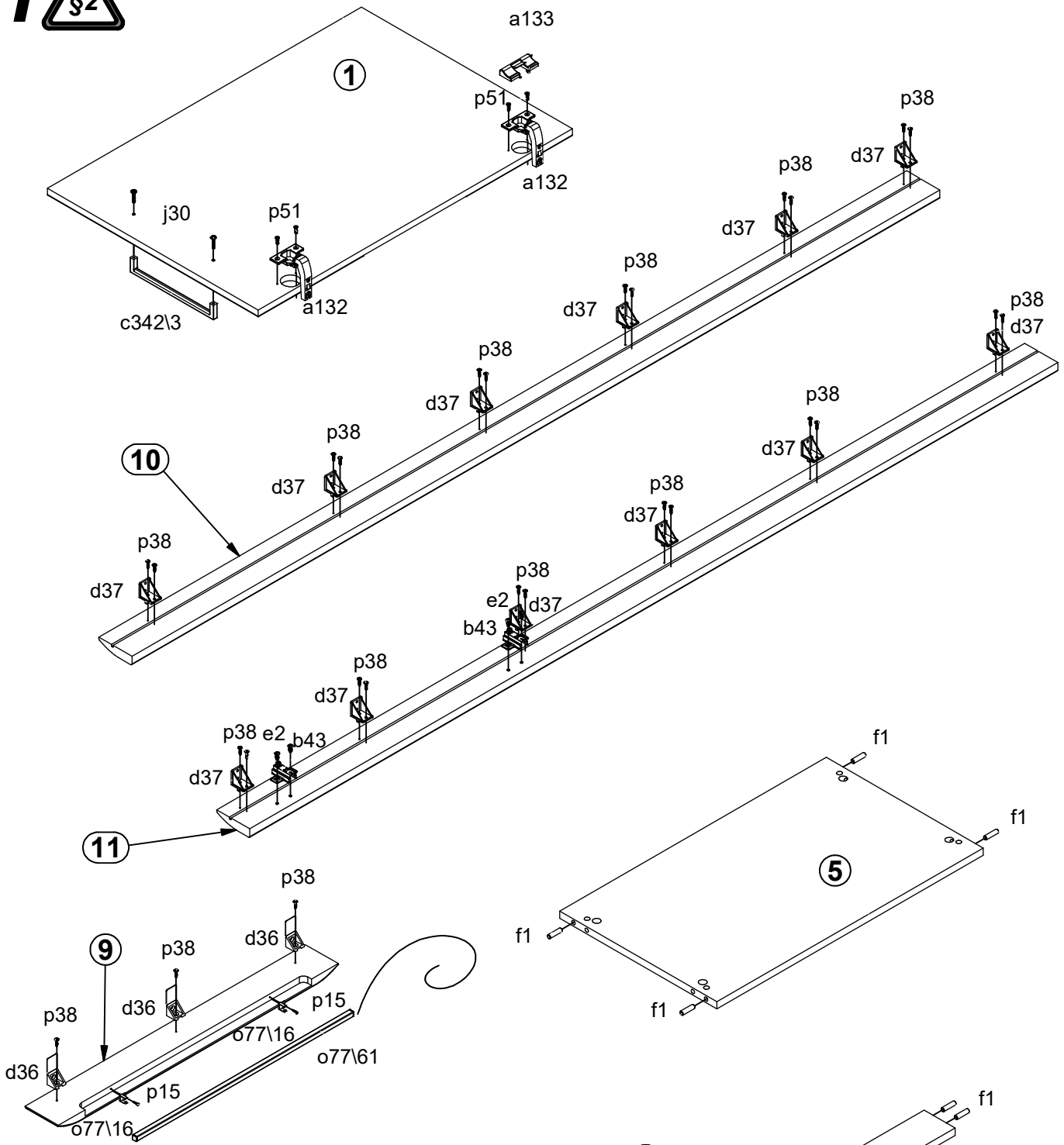

2

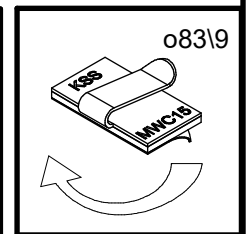
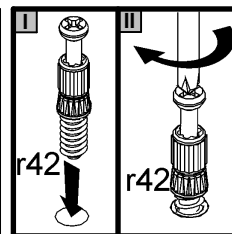
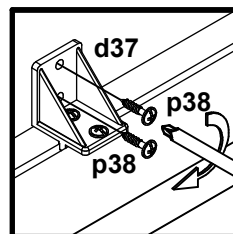
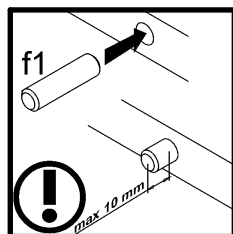
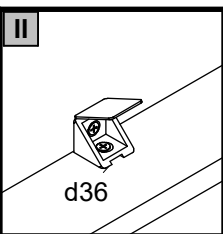
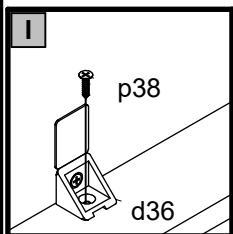
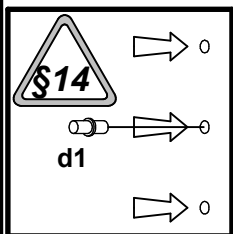
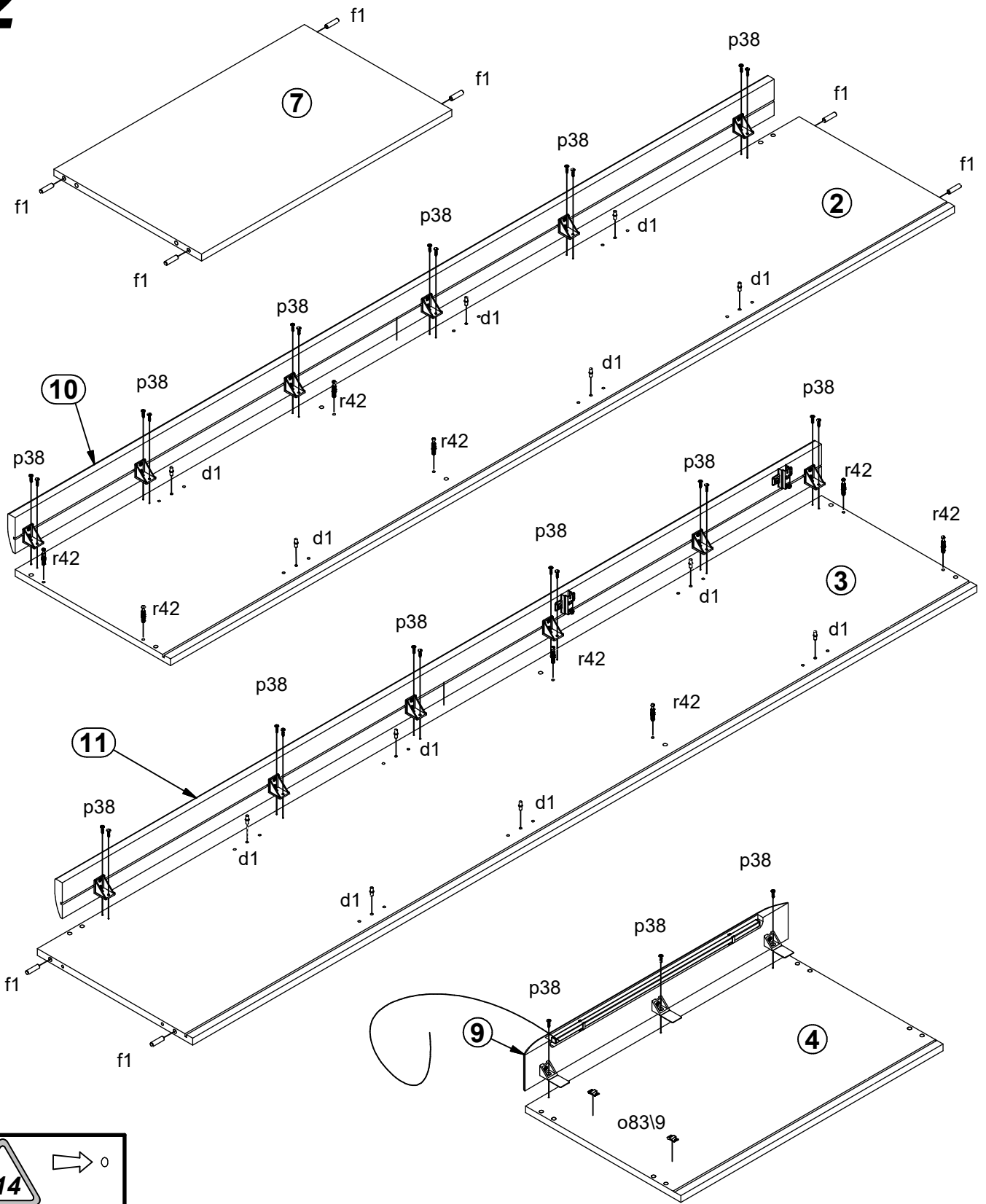

3

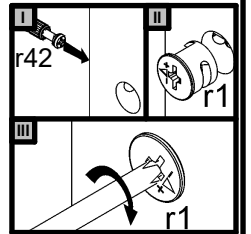
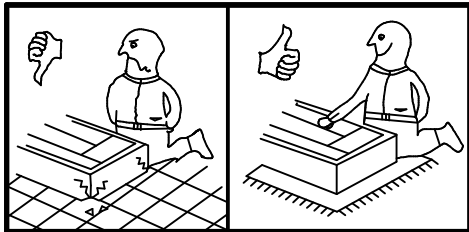
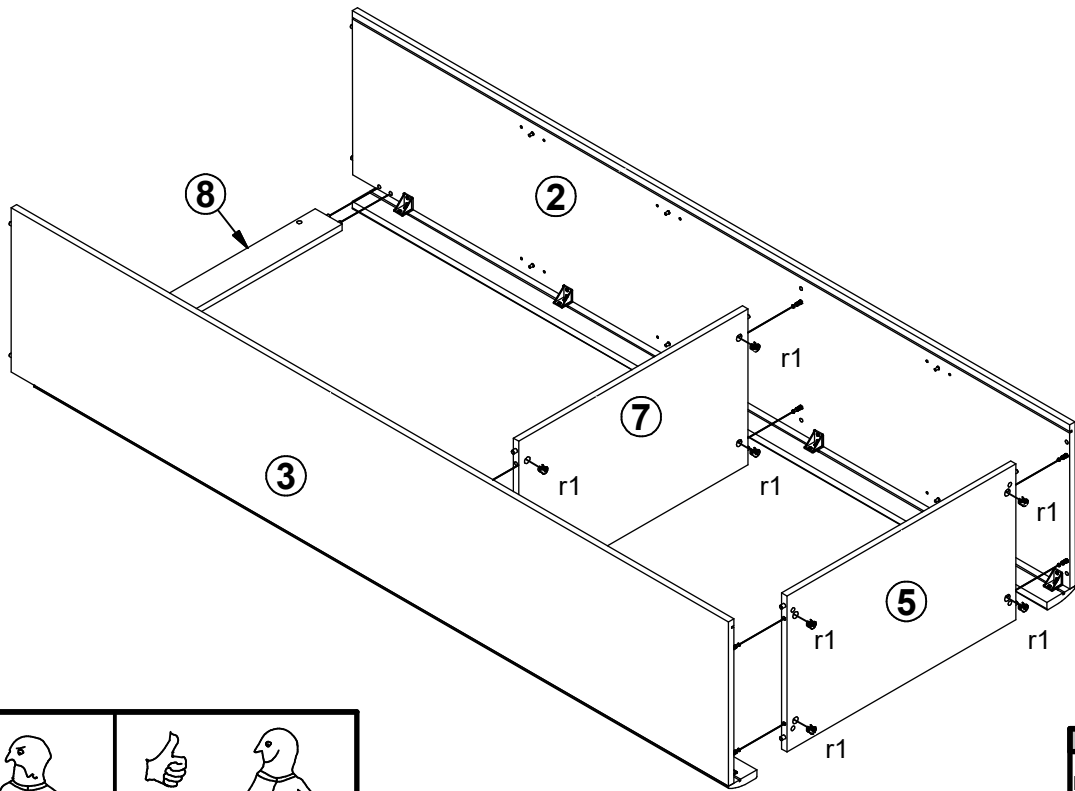

4

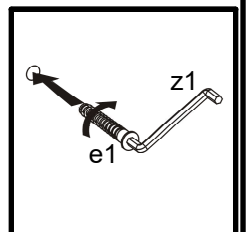
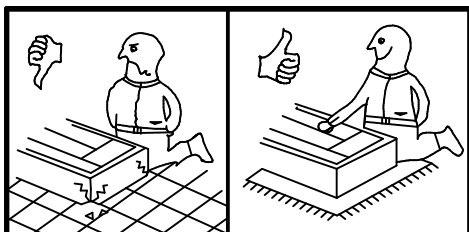
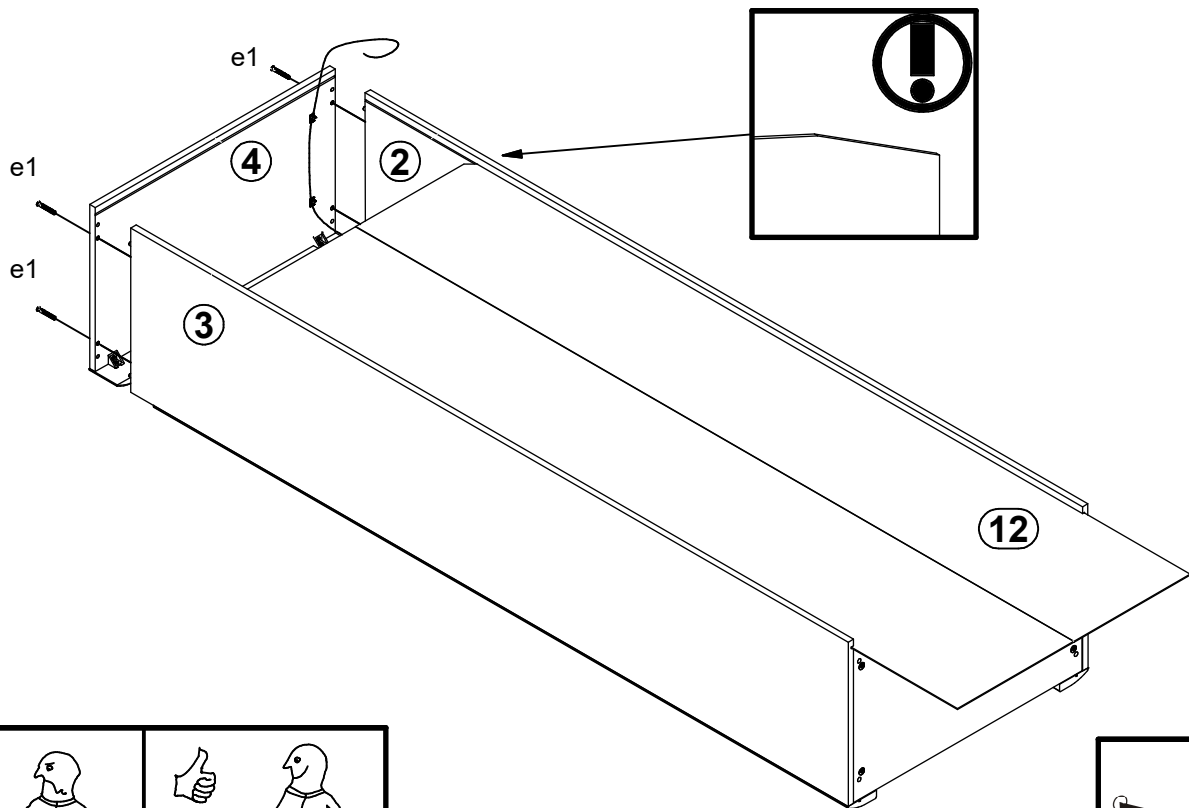

5

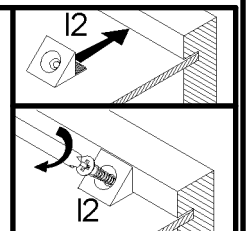
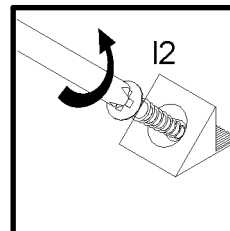
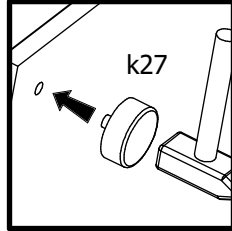
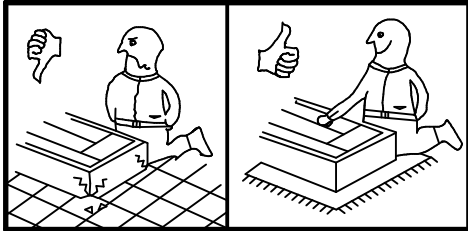
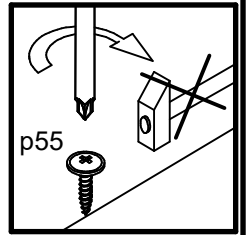
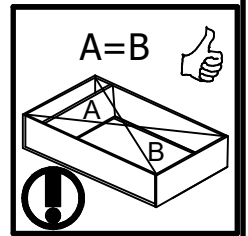
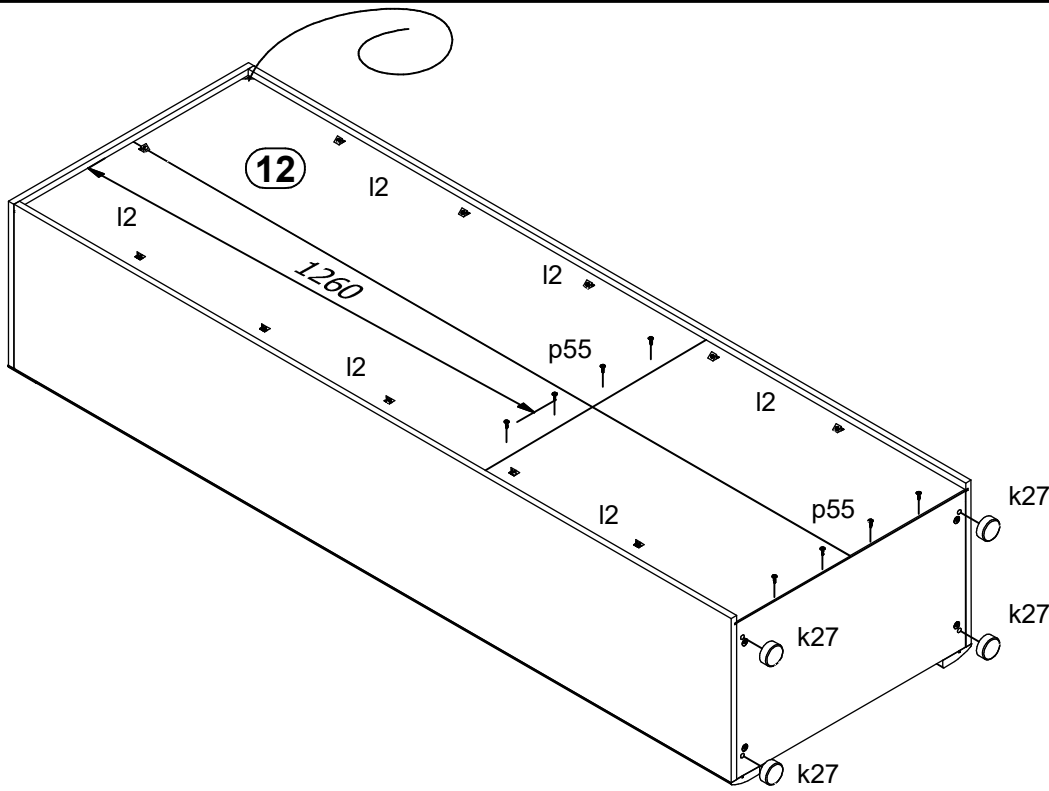

6

