

A**S553-POL****31-501- --**

2 / 6

A	B	C1	C2	C3	D
1	S553-3017	1420	230	38	1\1
2	S553-4007	1421	250	15	1\1

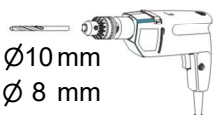
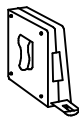
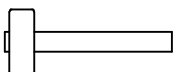
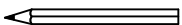
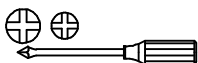
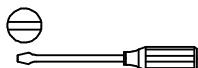
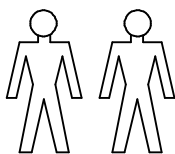

Ø10 mm
Ø 8 mm

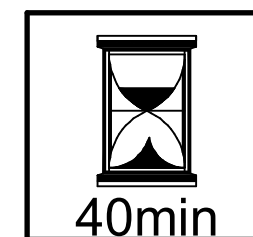
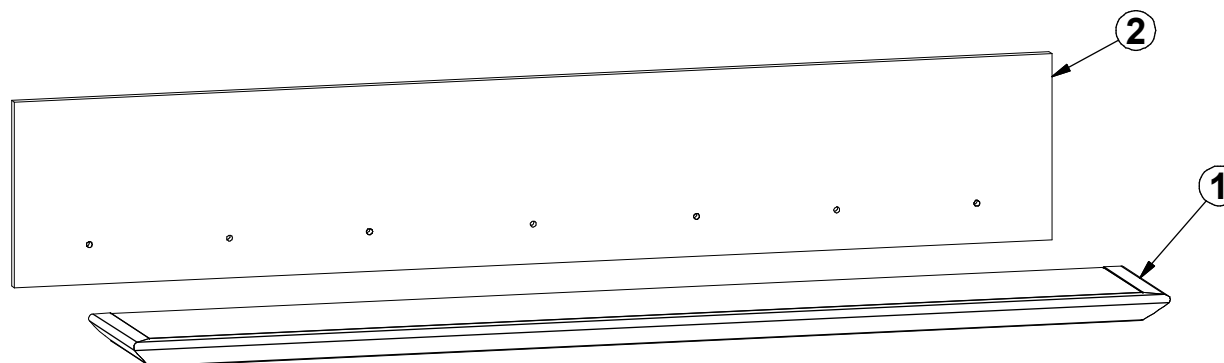
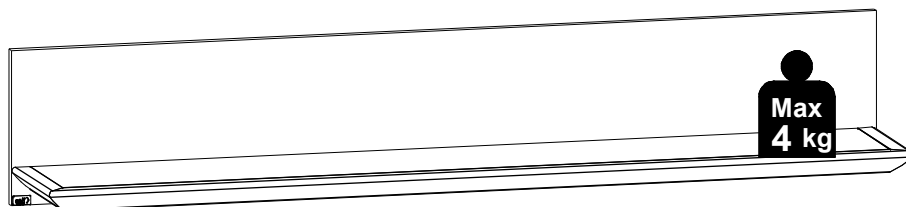

4x Ø5x11 mm e4	4x Ø7x60 mm e8	3x Ø8x30 mm f1	2x Ø10x50 mm f35	2x g2
1x Ø12x0,5 mm s59	6x Ø12.7x1.8mm s104	1x s93\5	2x Ø6x60 mm p75	1x z1

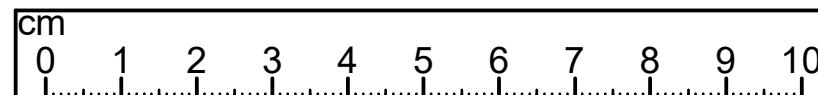

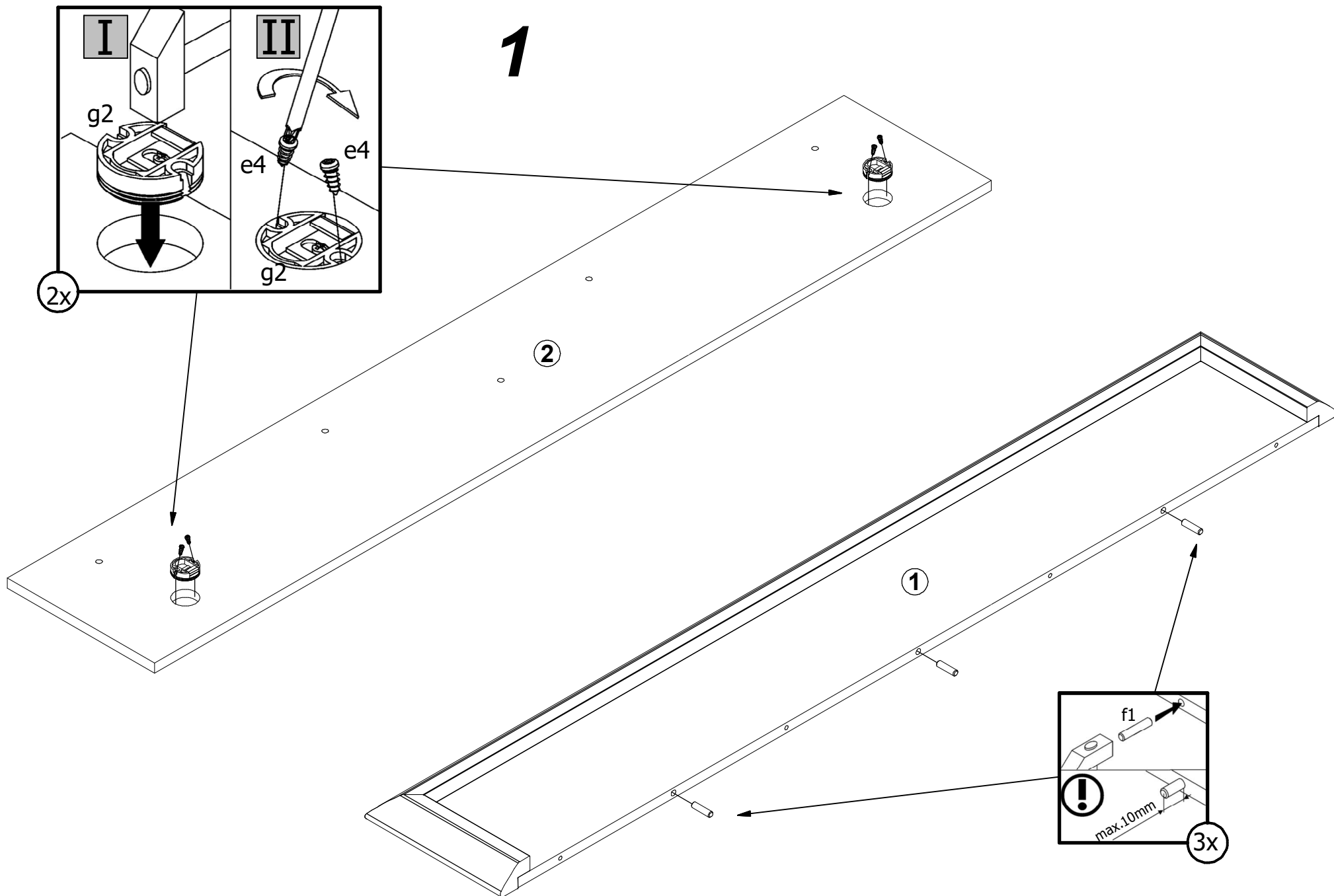

A

S553-POL

31-501- --

5 / 6

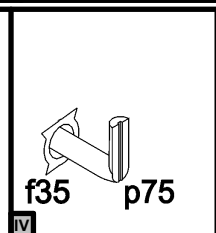
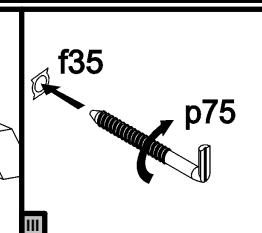
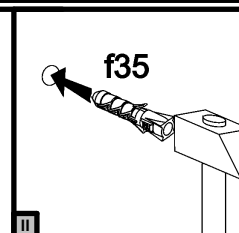
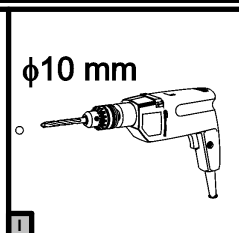
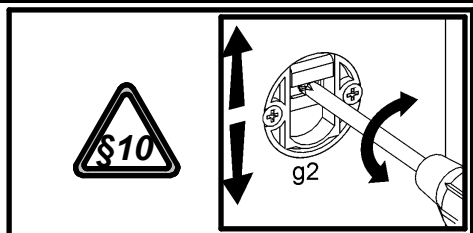
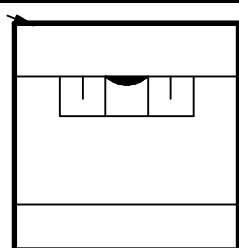

4

