

60 DP/DK-2100

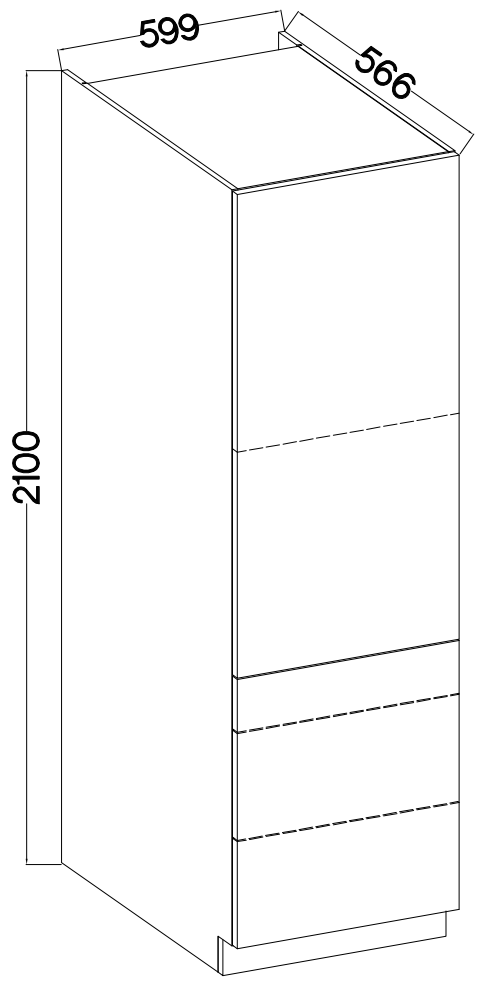

max. 10kg

KUH.30002
KUH.40007
KUH.40008

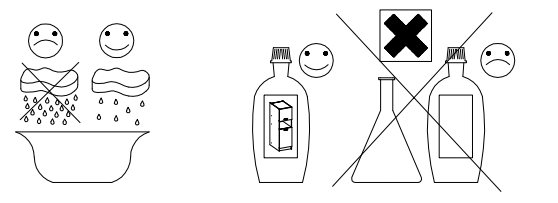
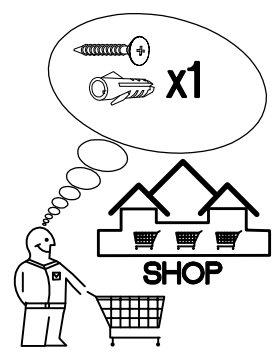
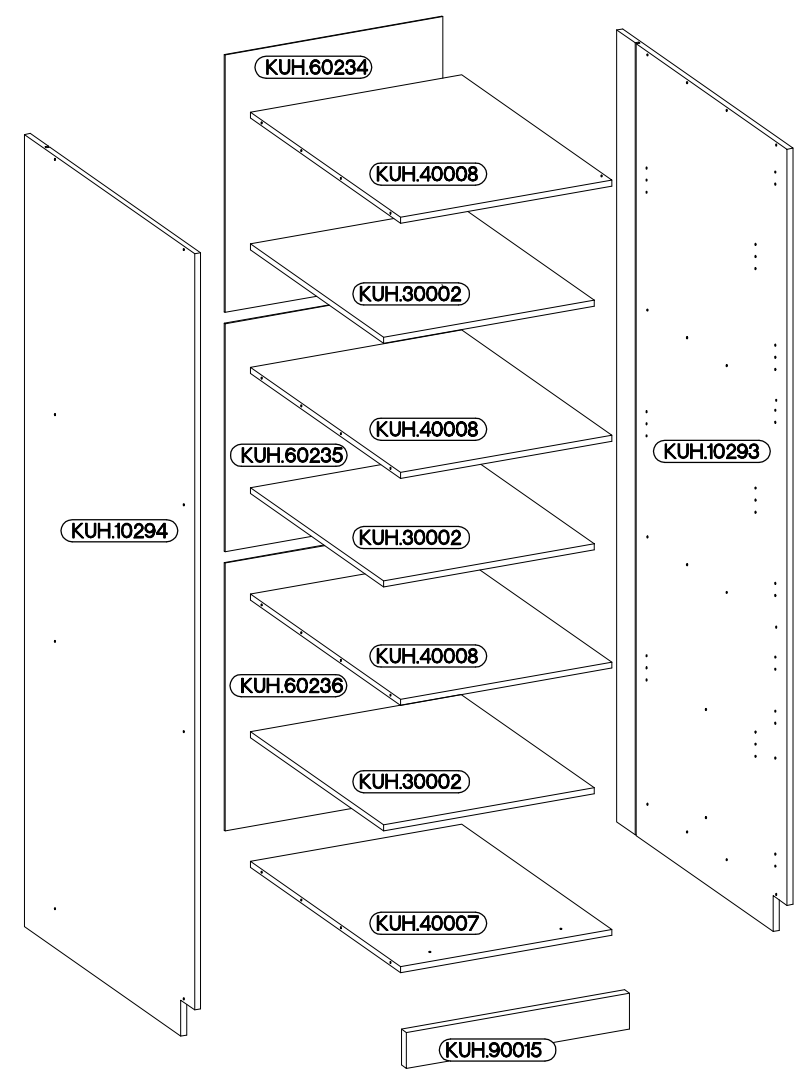

+8x30mm A 16	6,4 x 50mm B 16	E1 16	E9 2	6.5x48x16 F2 4	+35/0mm HG 5	
+5/19mm J 12	L2 8	L25 1	O 1	+4.0x45mm P4 2	+3.5x13mm P5 12	+3.0x20mm P7 15-20

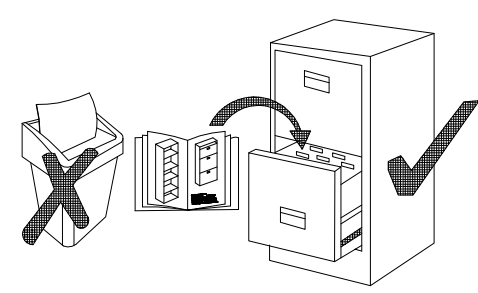

ISM-KUH-01147

1

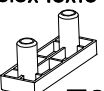
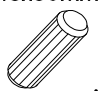
6.5x48x16	+8x30mm
	
F2	A
4	16

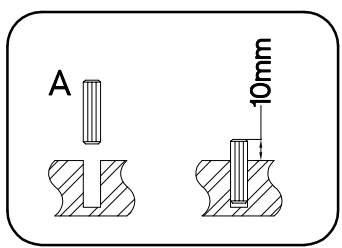
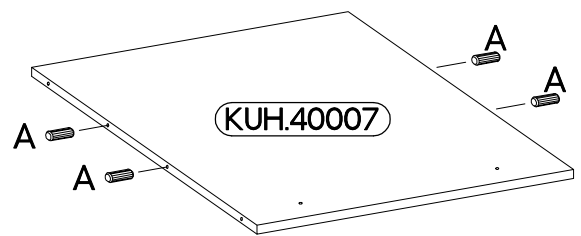
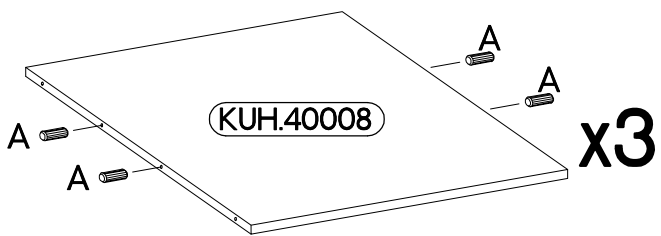
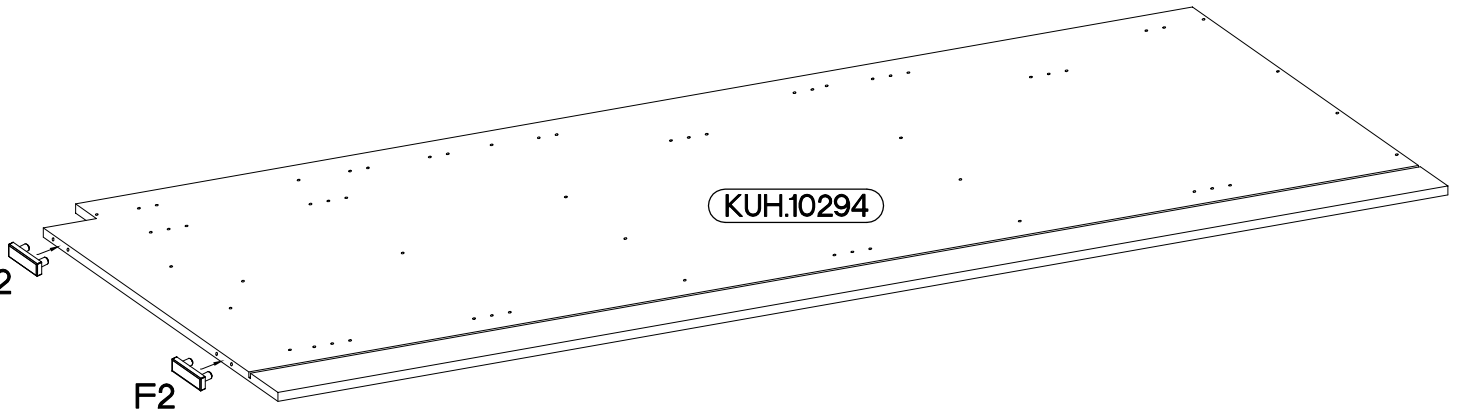
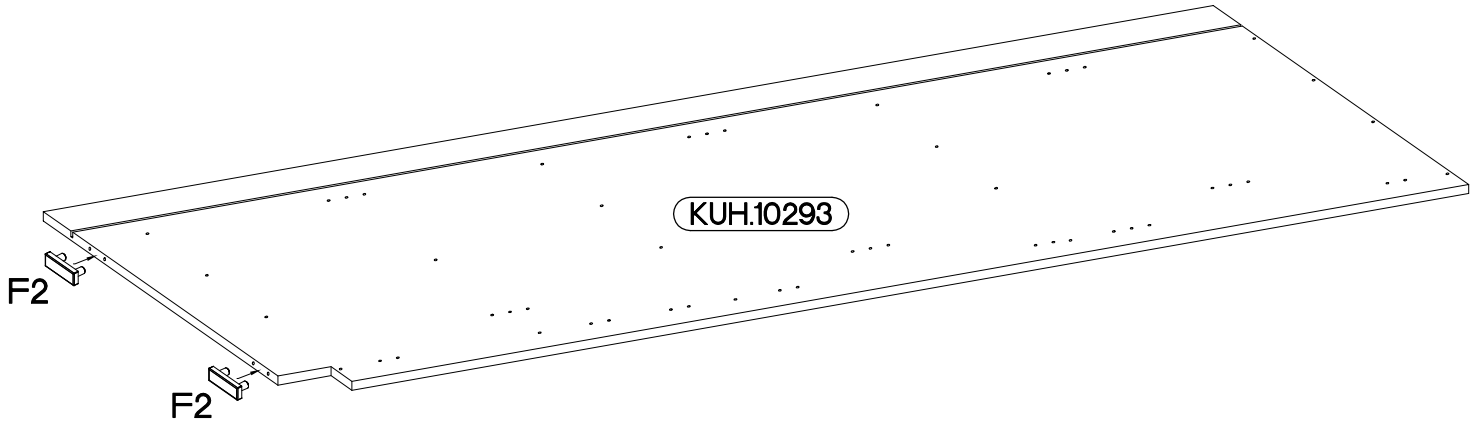
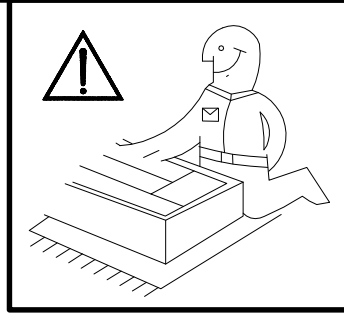
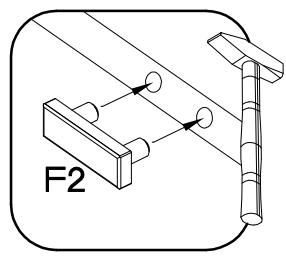

2

6,4 x 50mm

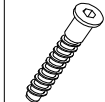

B

8

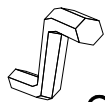

O

1



E1

8

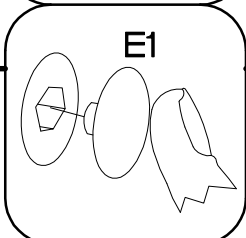
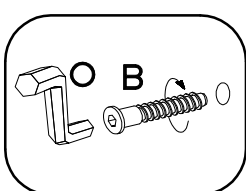
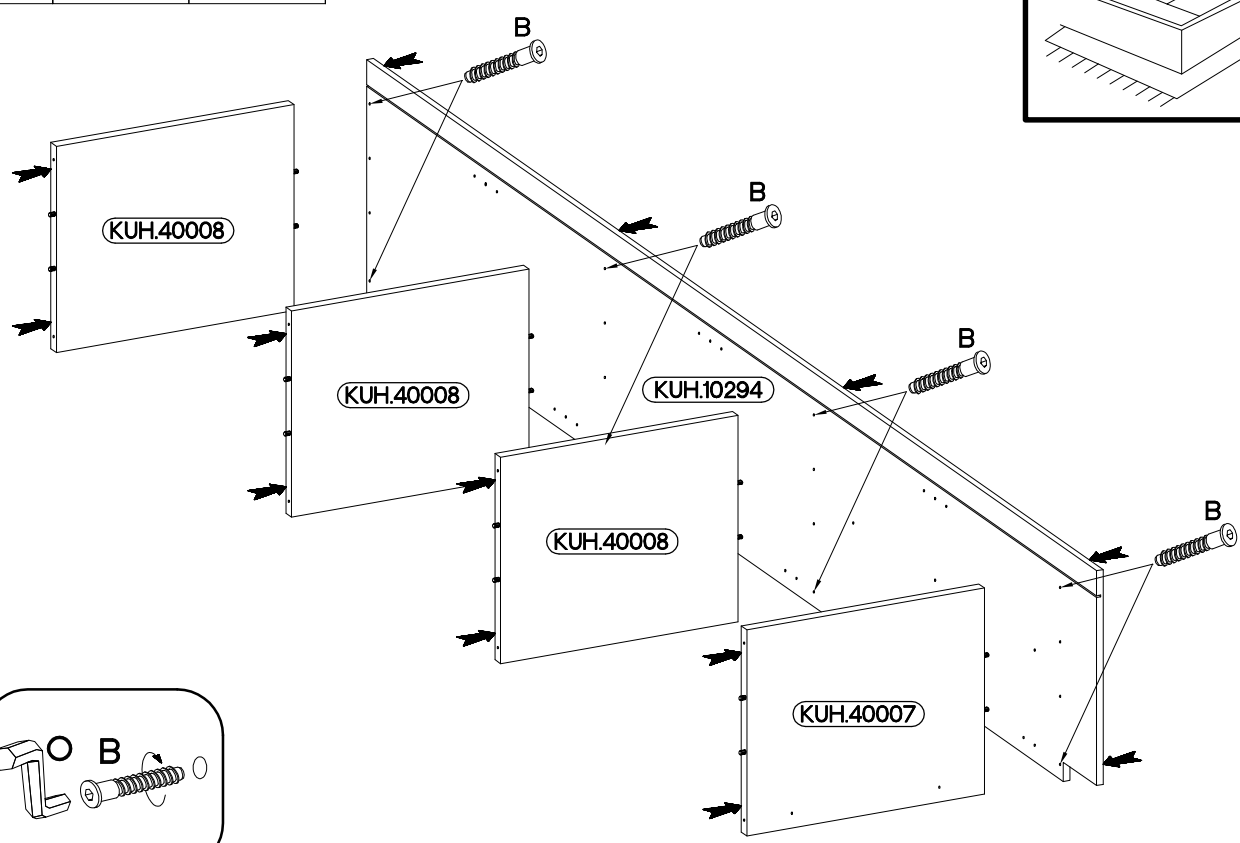
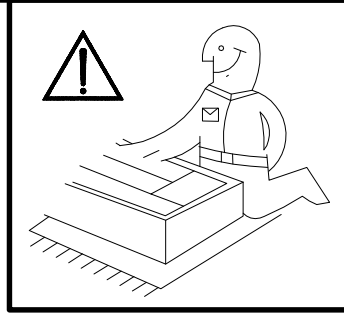

3

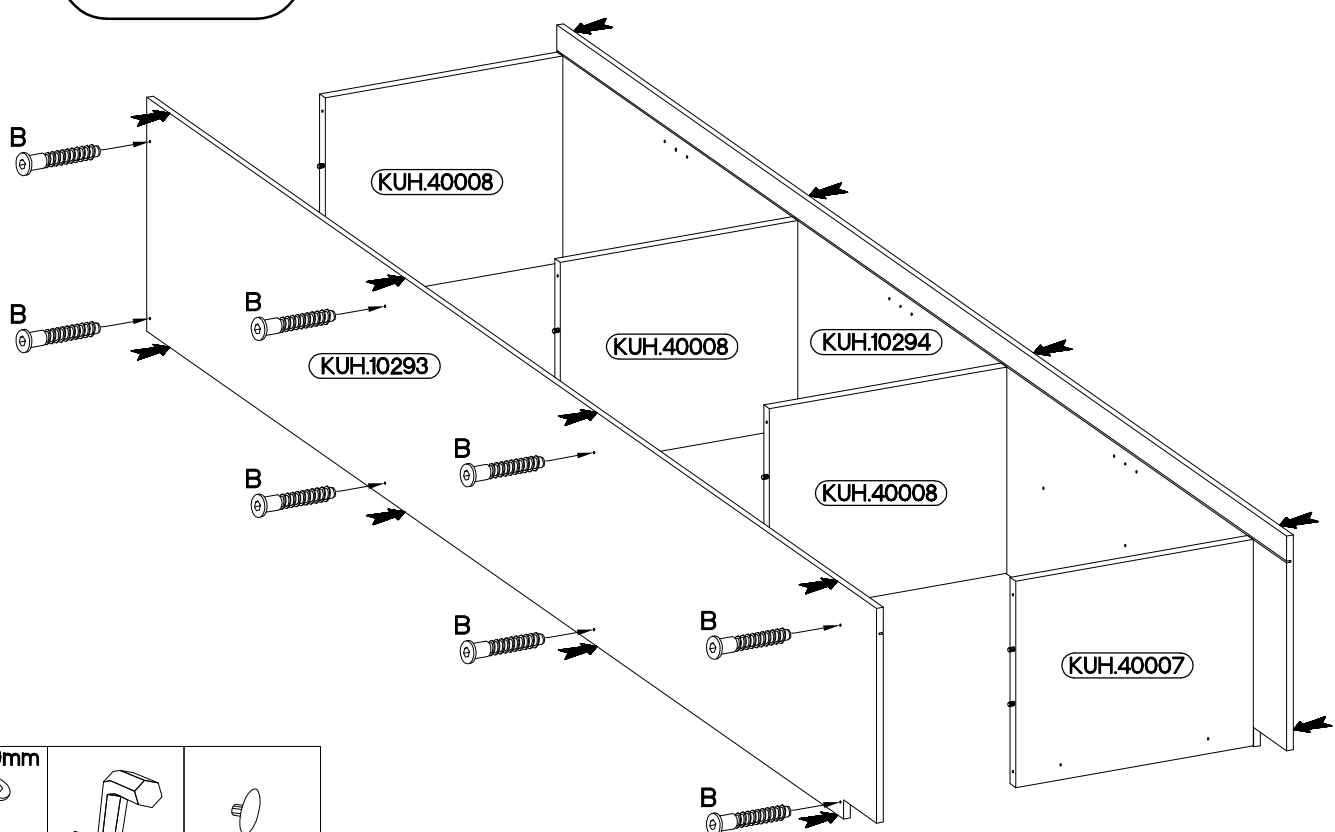

6,4 x 50mm

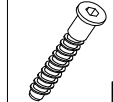

B

8

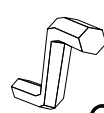

O

1



E1

8

60 DP-2100 2F

60 DPS-2100 1F 3S

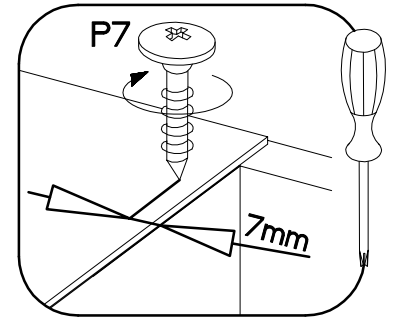
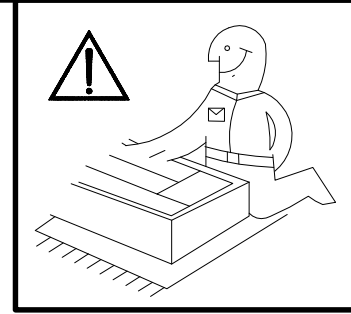
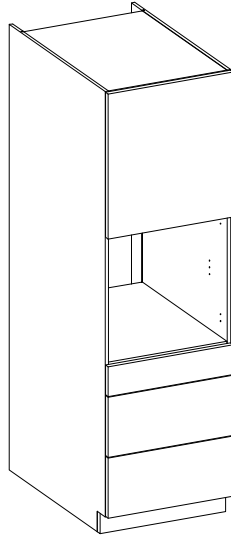
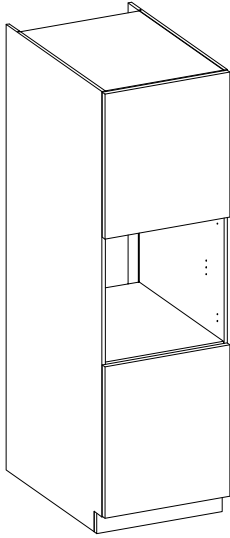

4

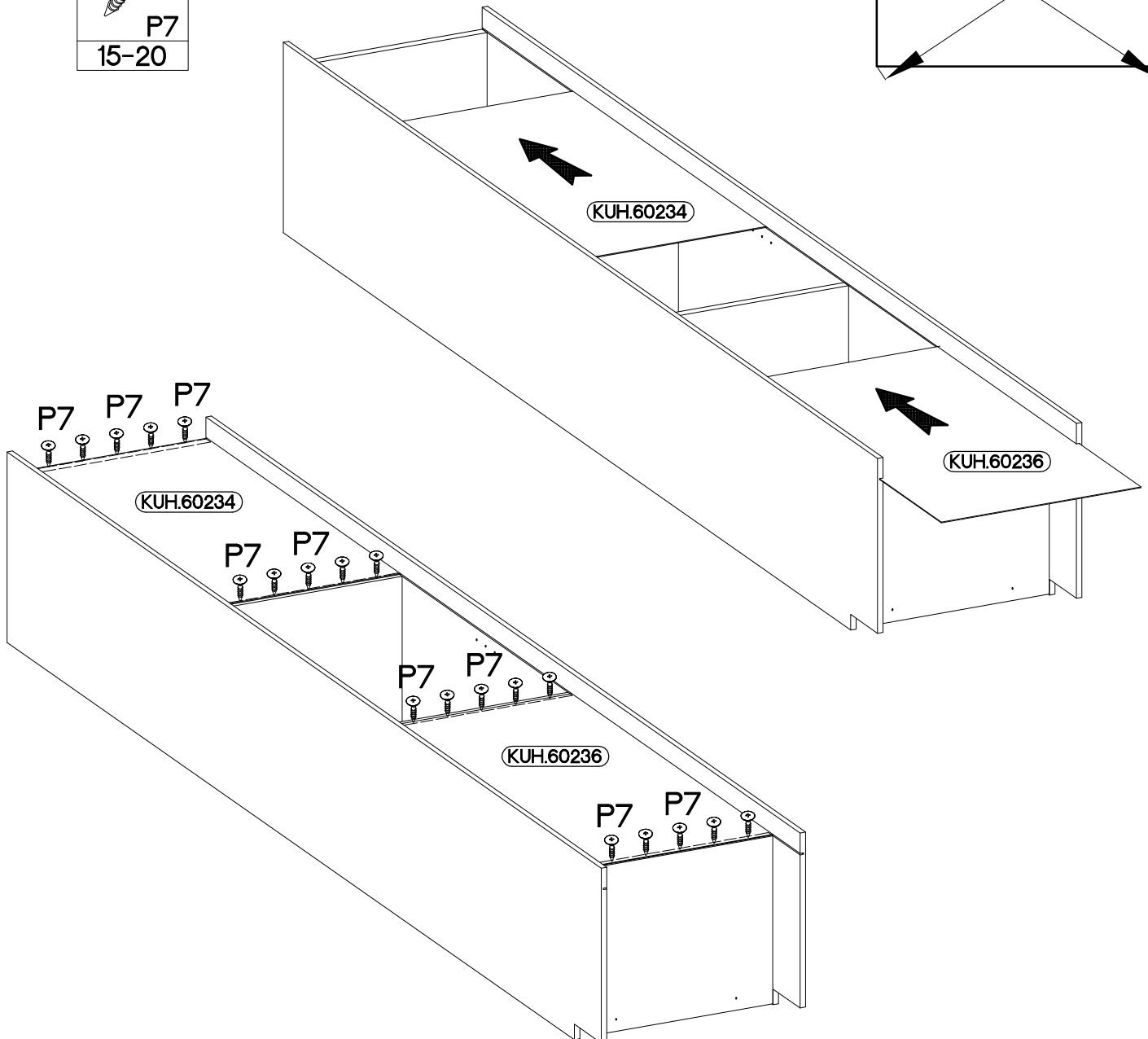
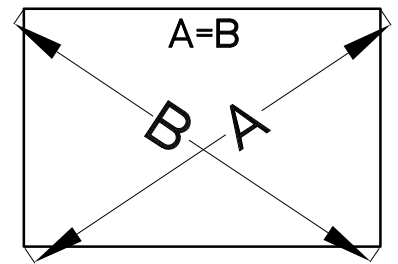
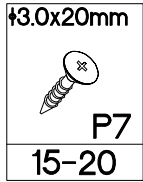

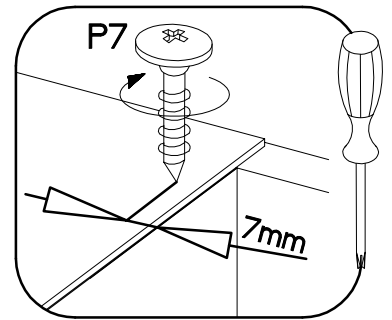
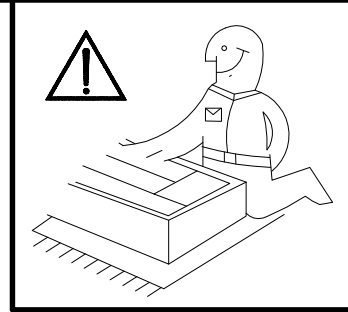
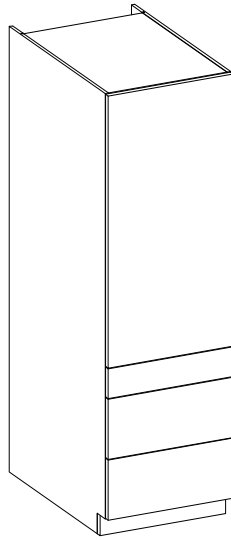
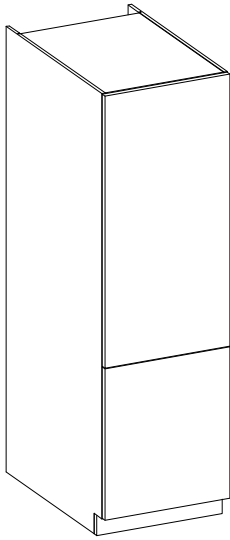

60 DK-2100 2F

60 DKS-2100 1F 3S

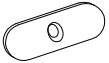

5

$\pm 3.0 \times 20 \text{mm}$	
	L2
15-20	8

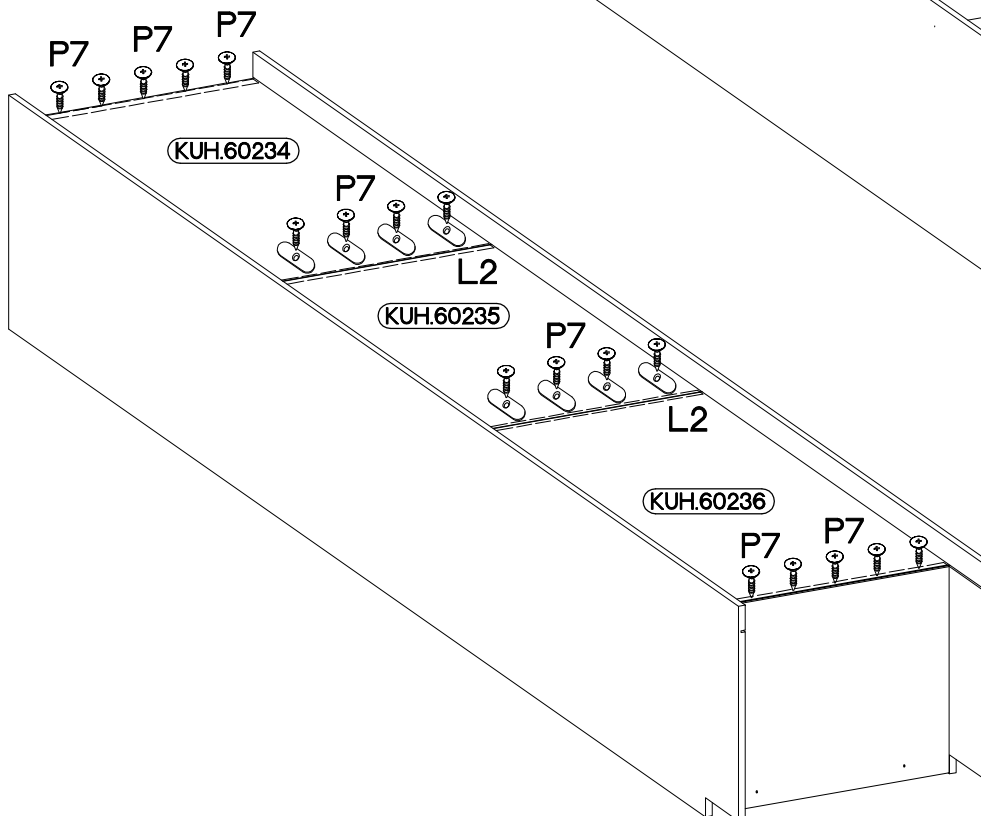
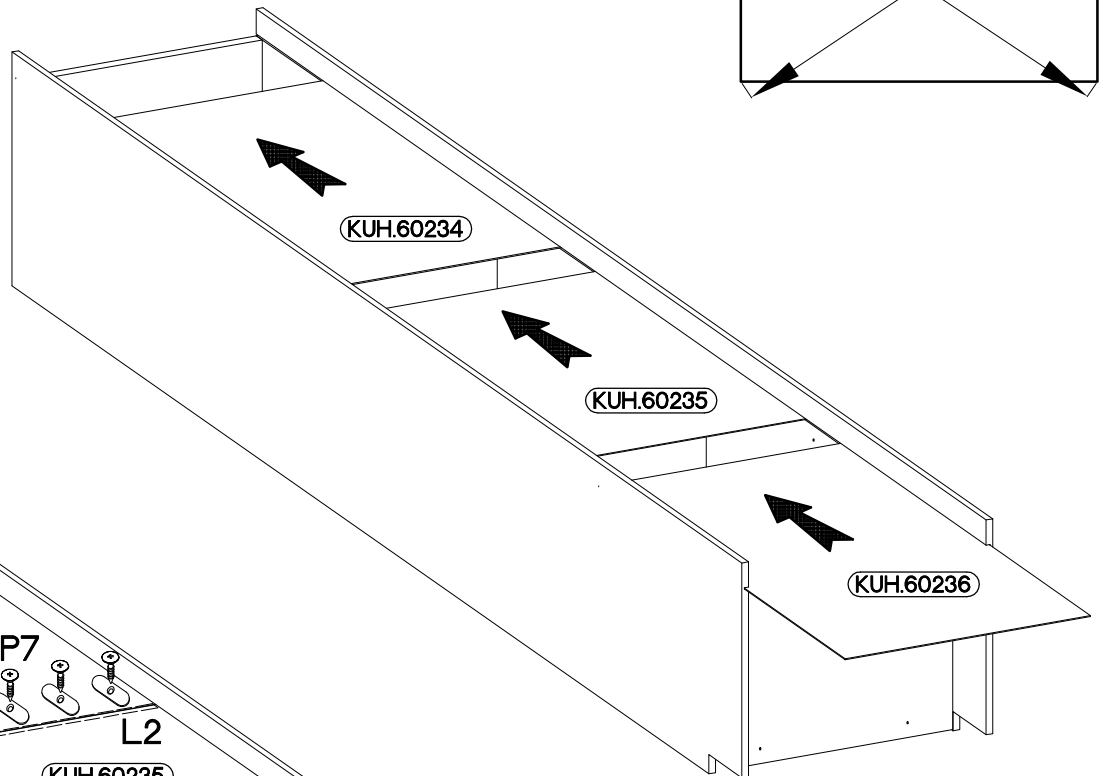
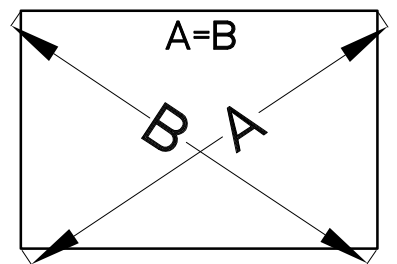

6

+4.0x45mm



P4

2



E9

2

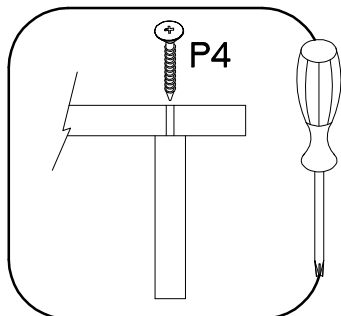
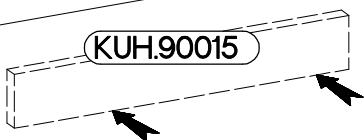
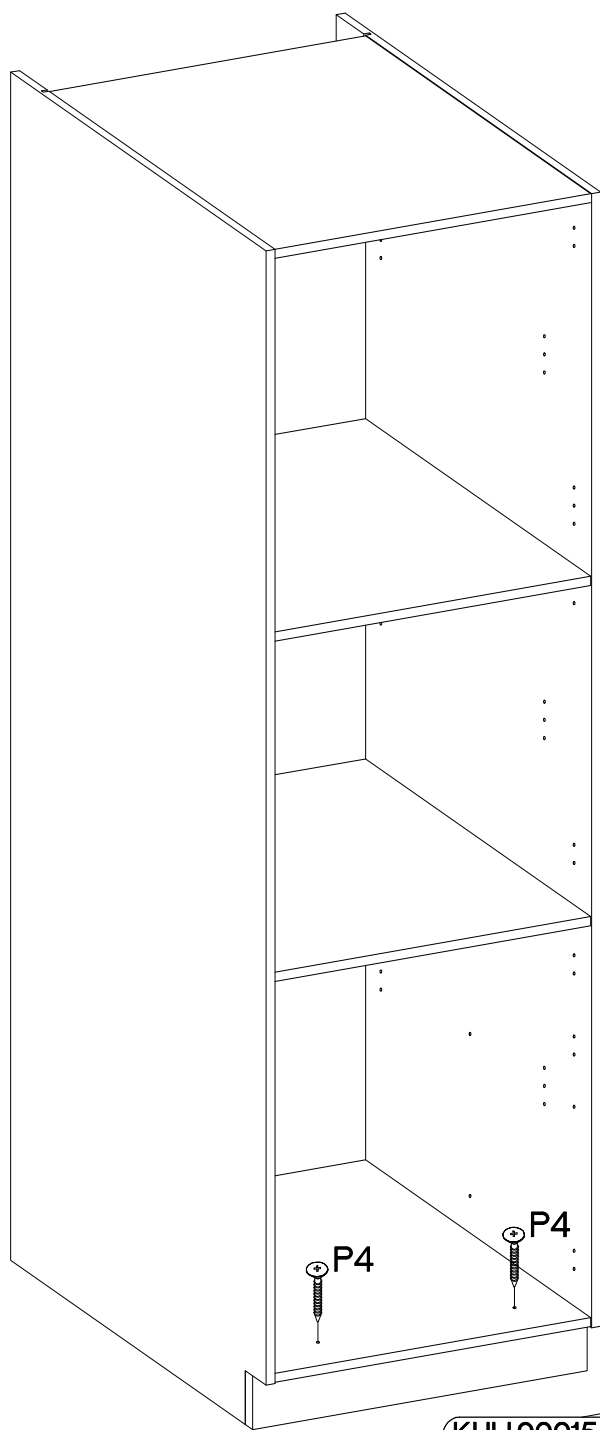

7



+5/19mm

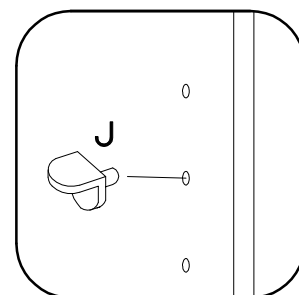
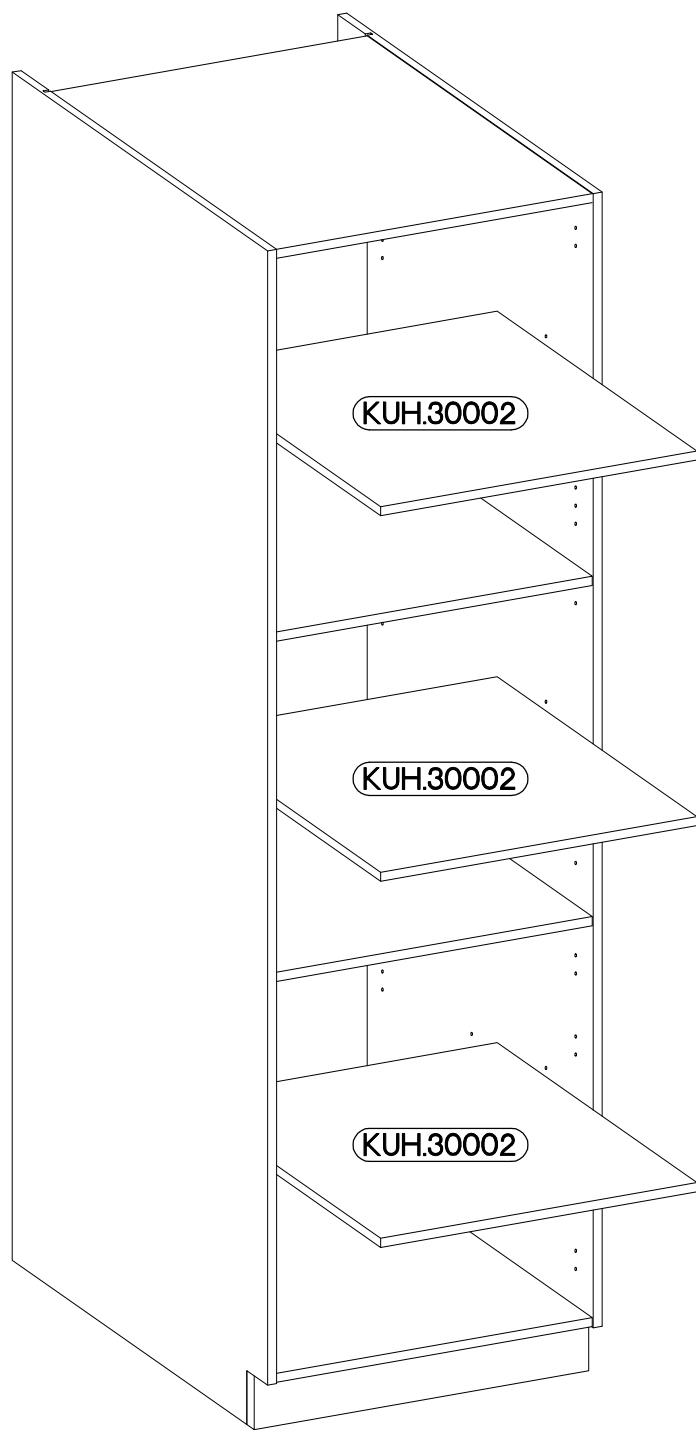

J

12

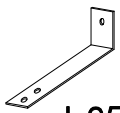

 L25 1	$\pm 3.5 \times 13 \text{mm}$  P5 2
--	--

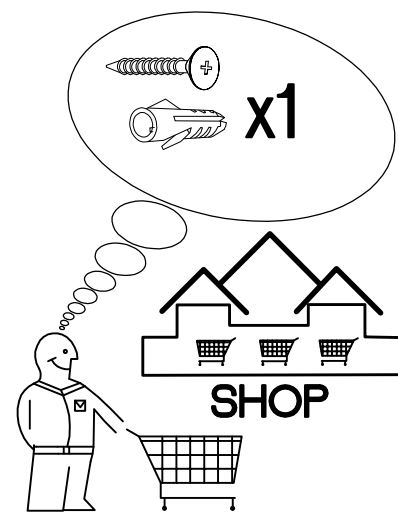
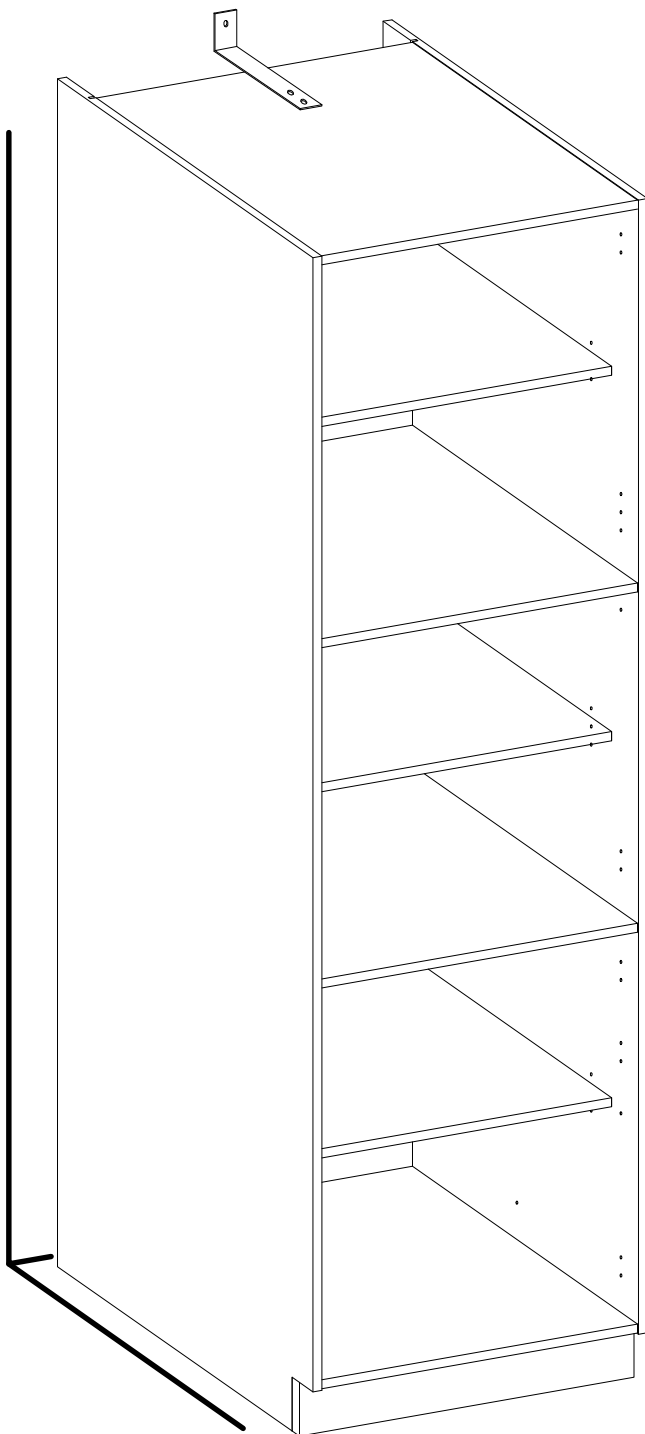
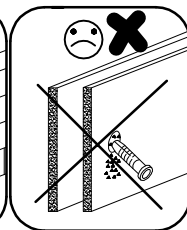
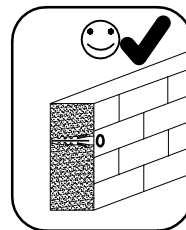
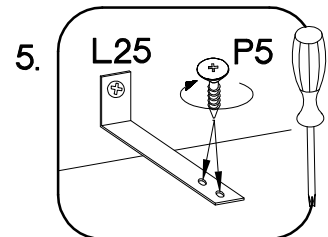
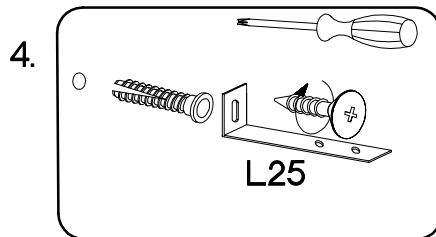
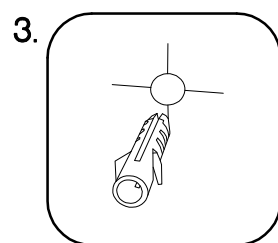
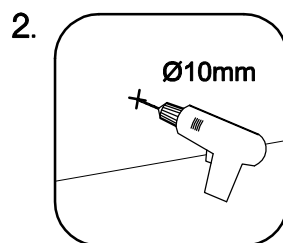
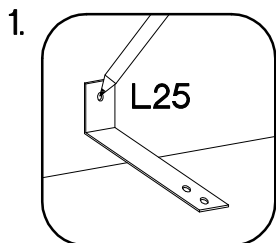

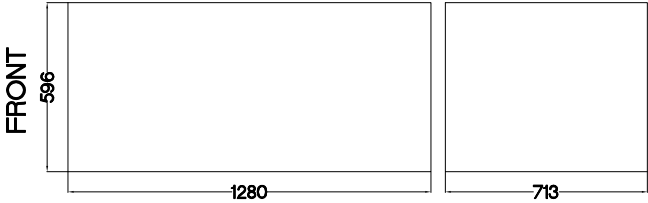
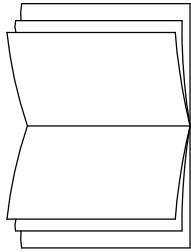

60 DK-2100 2F

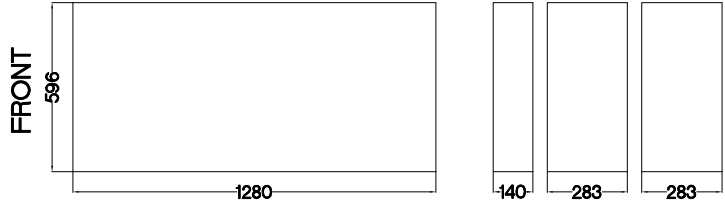
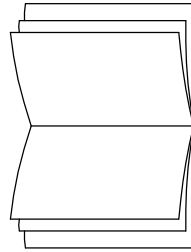
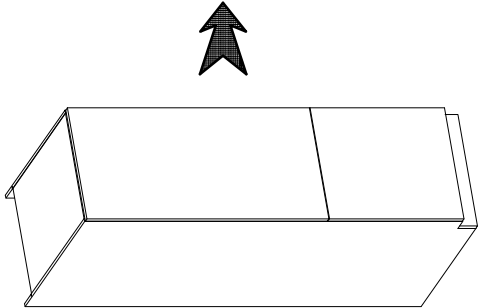

60 DKS-2100 1F 3S

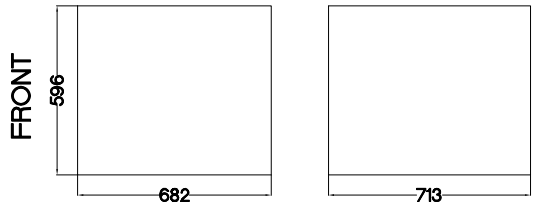
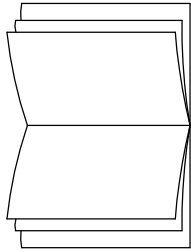
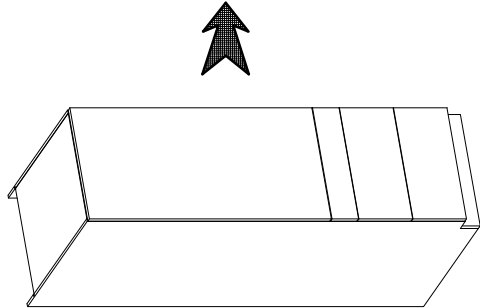

60 DP-2100 2F

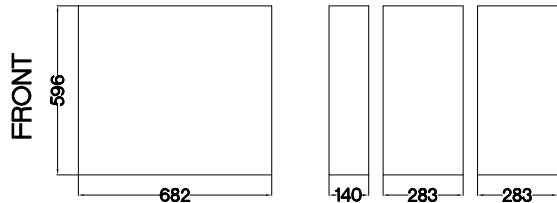
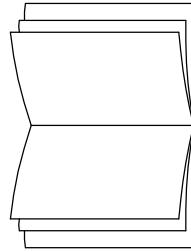
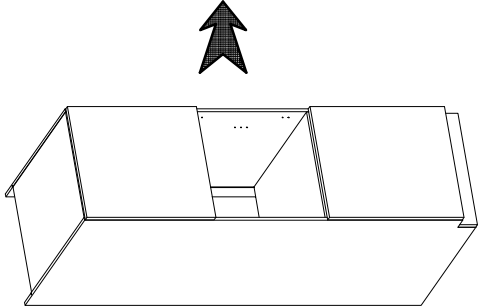

60 DPS-2100 1F 3S

