

MONTAŽNI LIST (SERVICE-CARD)

Ime izdelka (Item name):
LIFT

KERLES, www.kerles.si
info@kerles.si Gsm: 041 638 348

Tip izdelka (Type):
POSTELJA

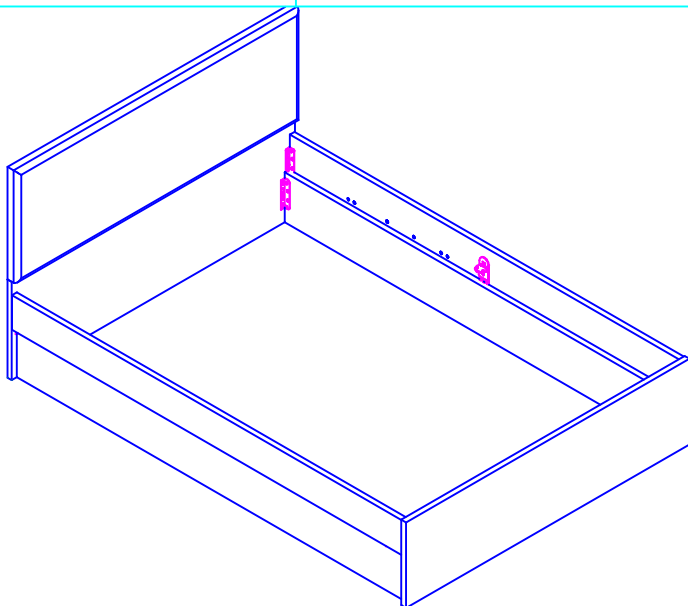

Dragi kupec,

kupili ste proizvod podjetja Kerles. Za sestavo izdelka sta potrebni dve odrasli osebi. Pred pričetkom sestave izdelka si pozorno pogledite montažne liste ter si elemente razvrstite tako, kot je prikazano na skici A.

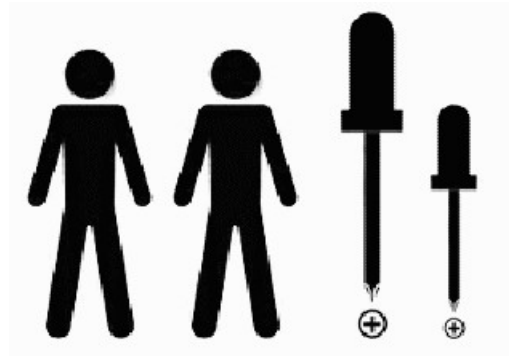

Skica A

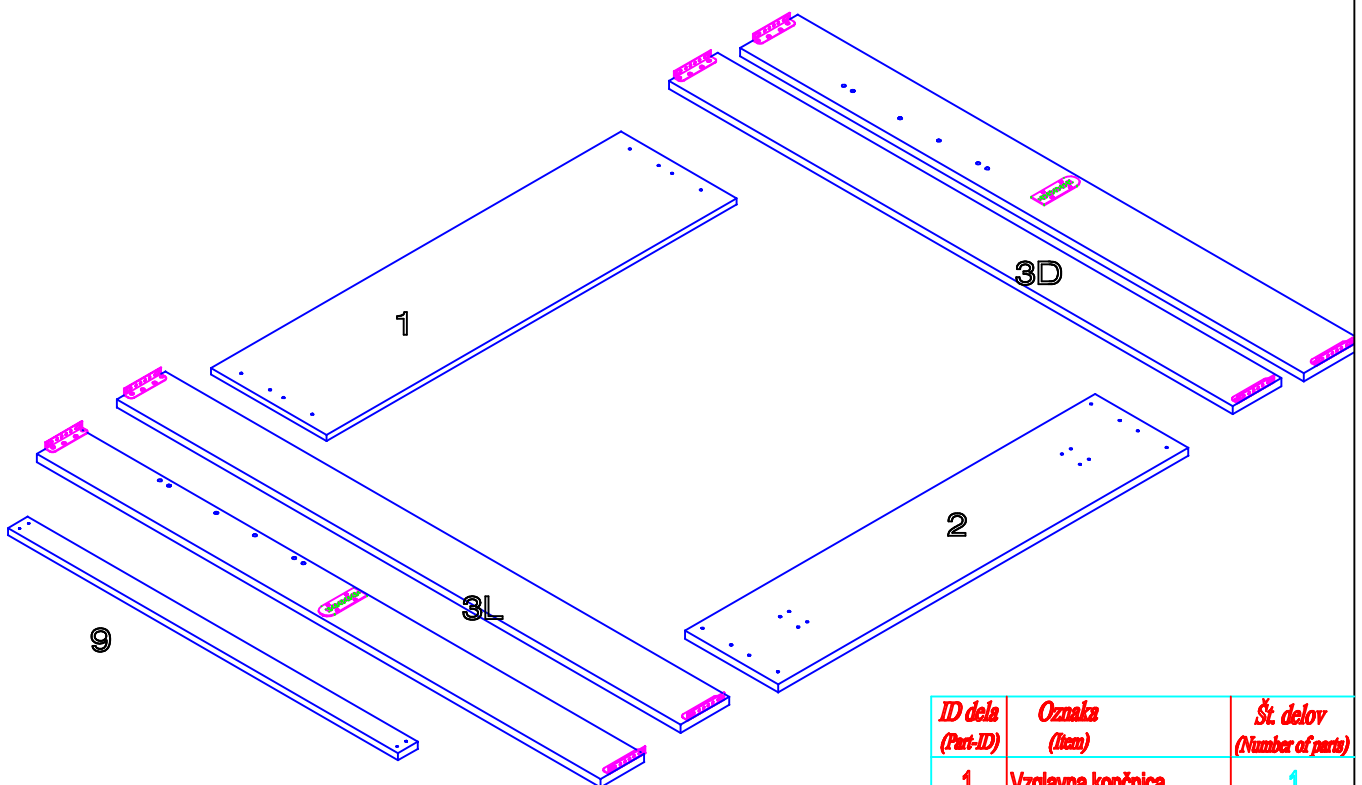

ID dela (Part-ID)	Oznaka (Item)	Št. delov (Number of parts)
1	Vzglavna končnica	1
2	Vznožna končnica	1
3D	Stranica desna	1
3L	Stranica leva	1
9	Križna letev	1



Korak (Step) 1:

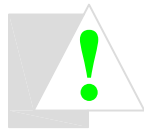
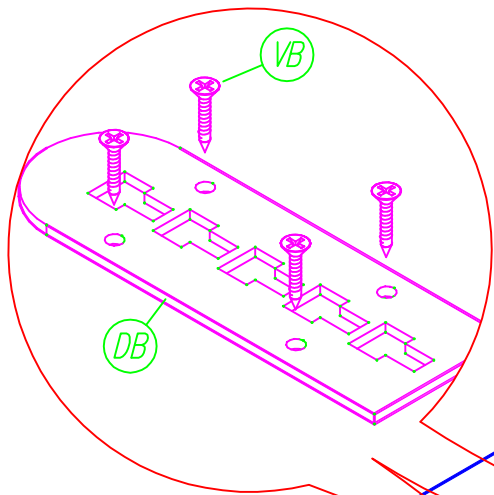

Pozor! (Attention!)

Vijak (MI) privijemo samo za $\frac{1}{3}$ navojnega stebla.

Tighten up the (MI) screw - using only $\frac{1}{3}$ of the thread.

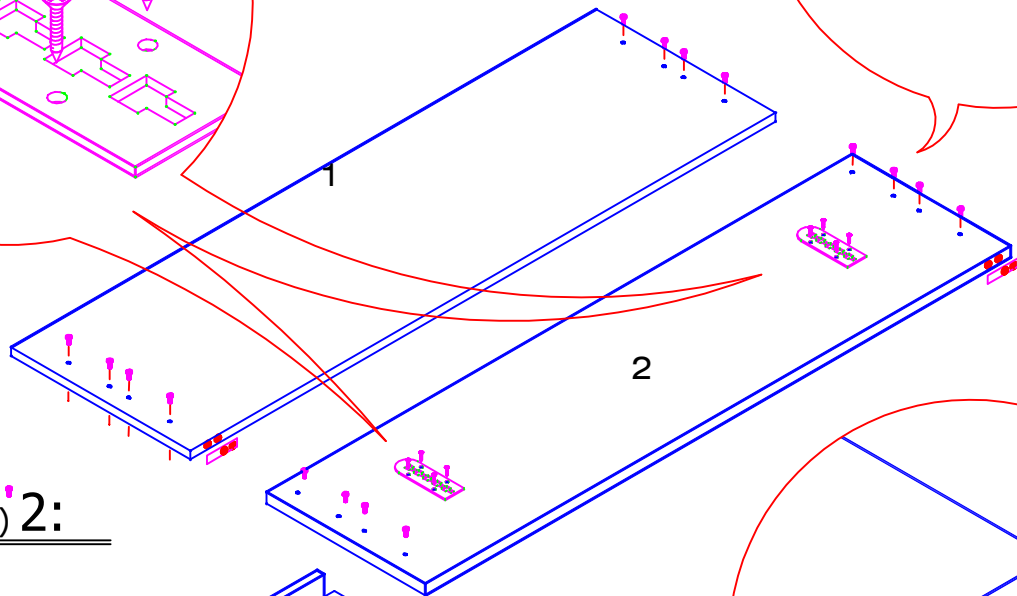
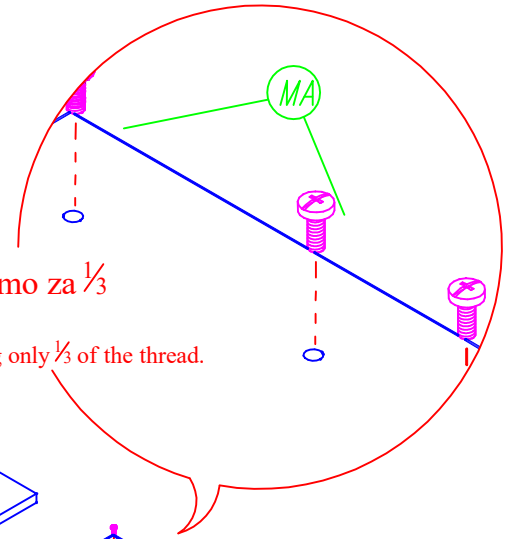

Korak (Step) 2:

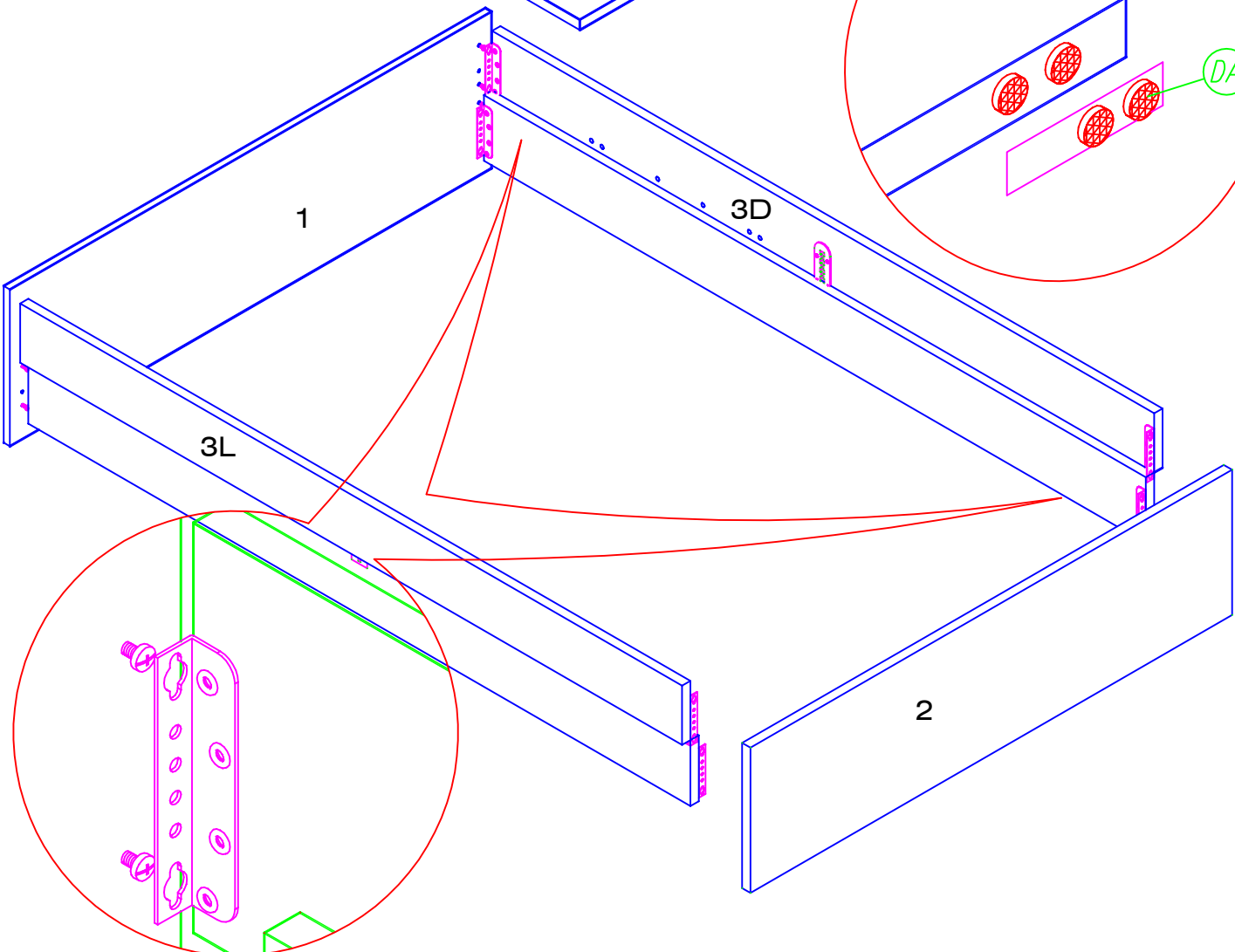
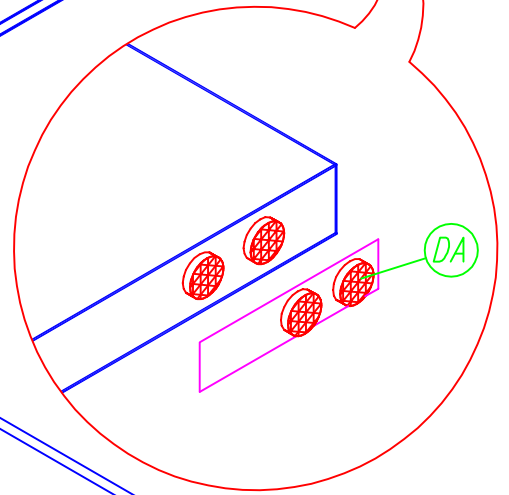

Korak (Step) 3:

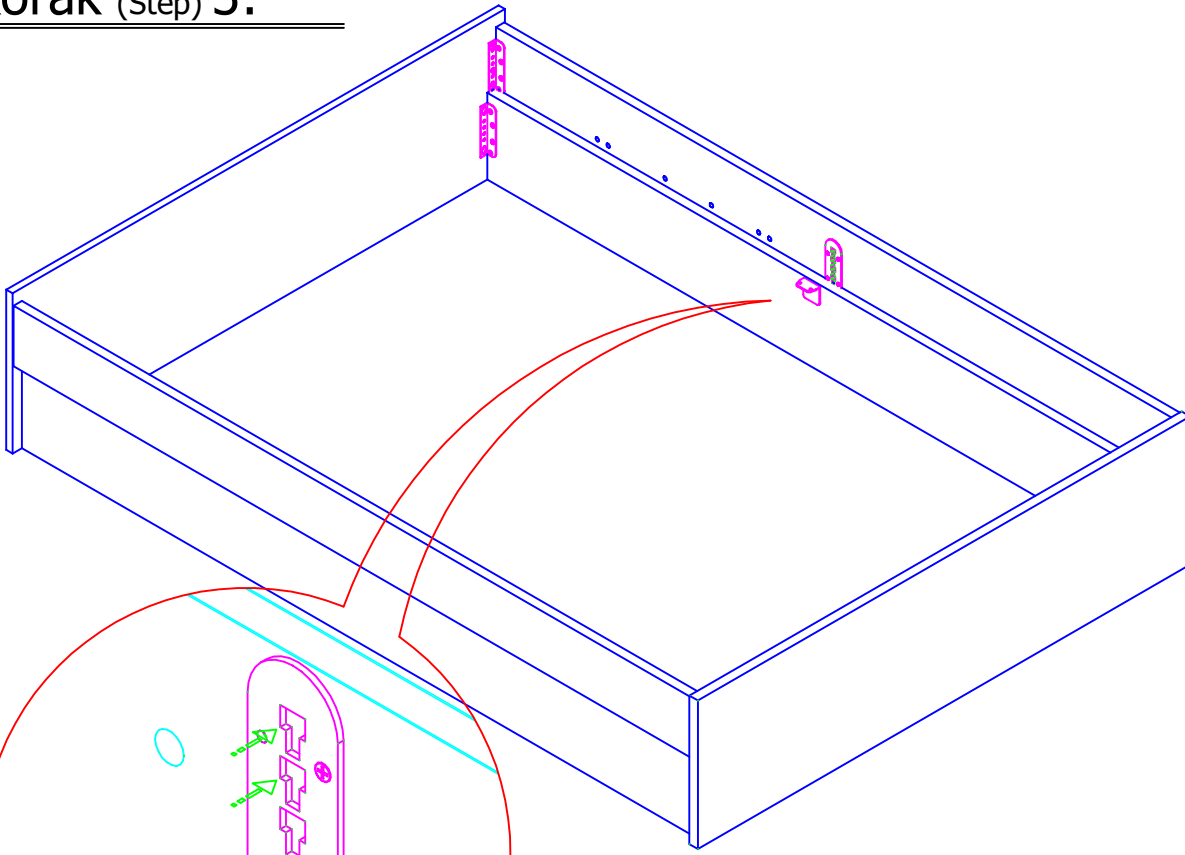

Pozor! (Attention!)

Okovje (DC) na vznožni stranici nasadimo na zgornji dve luknji.

Korak (Step) 4:

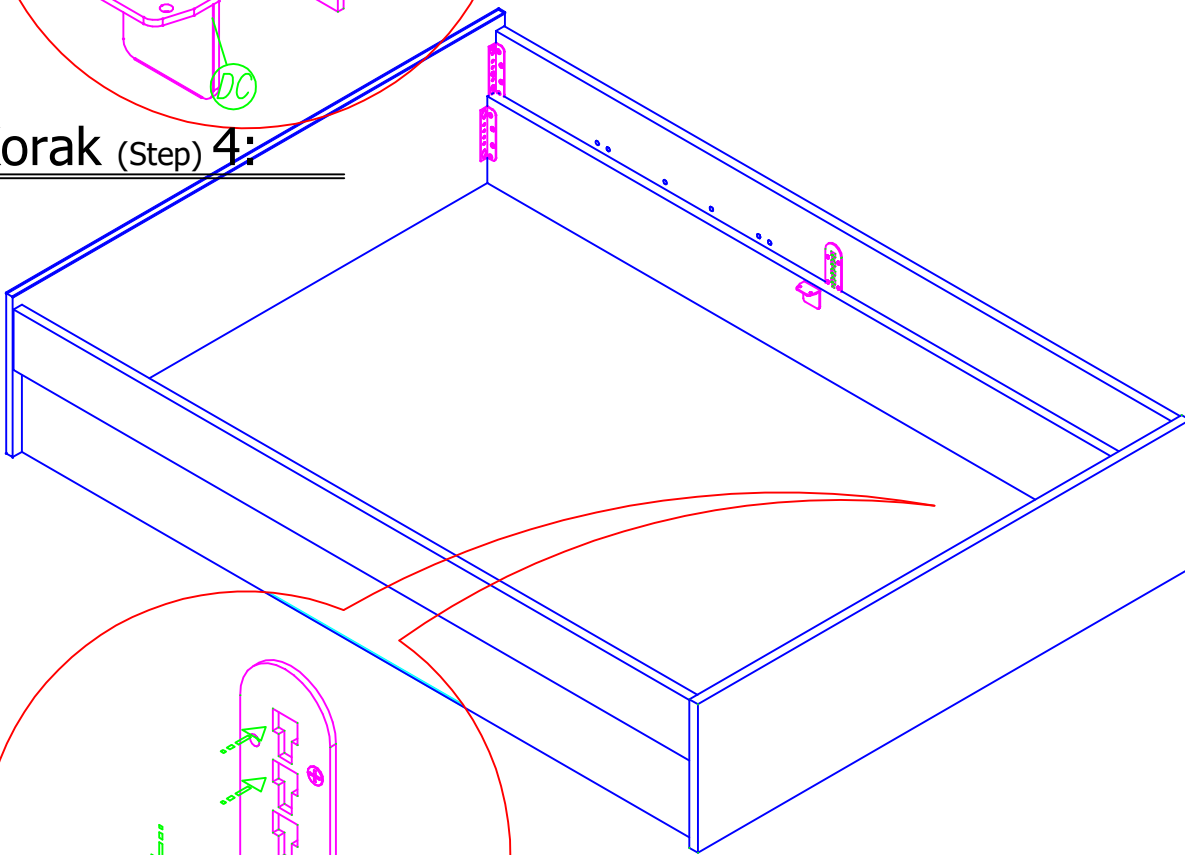

Pozor! (Attention!)

Okovje (DC) na vznožni stranici nasadimo na zgornji dve luknji.

Korak (Step) 5:

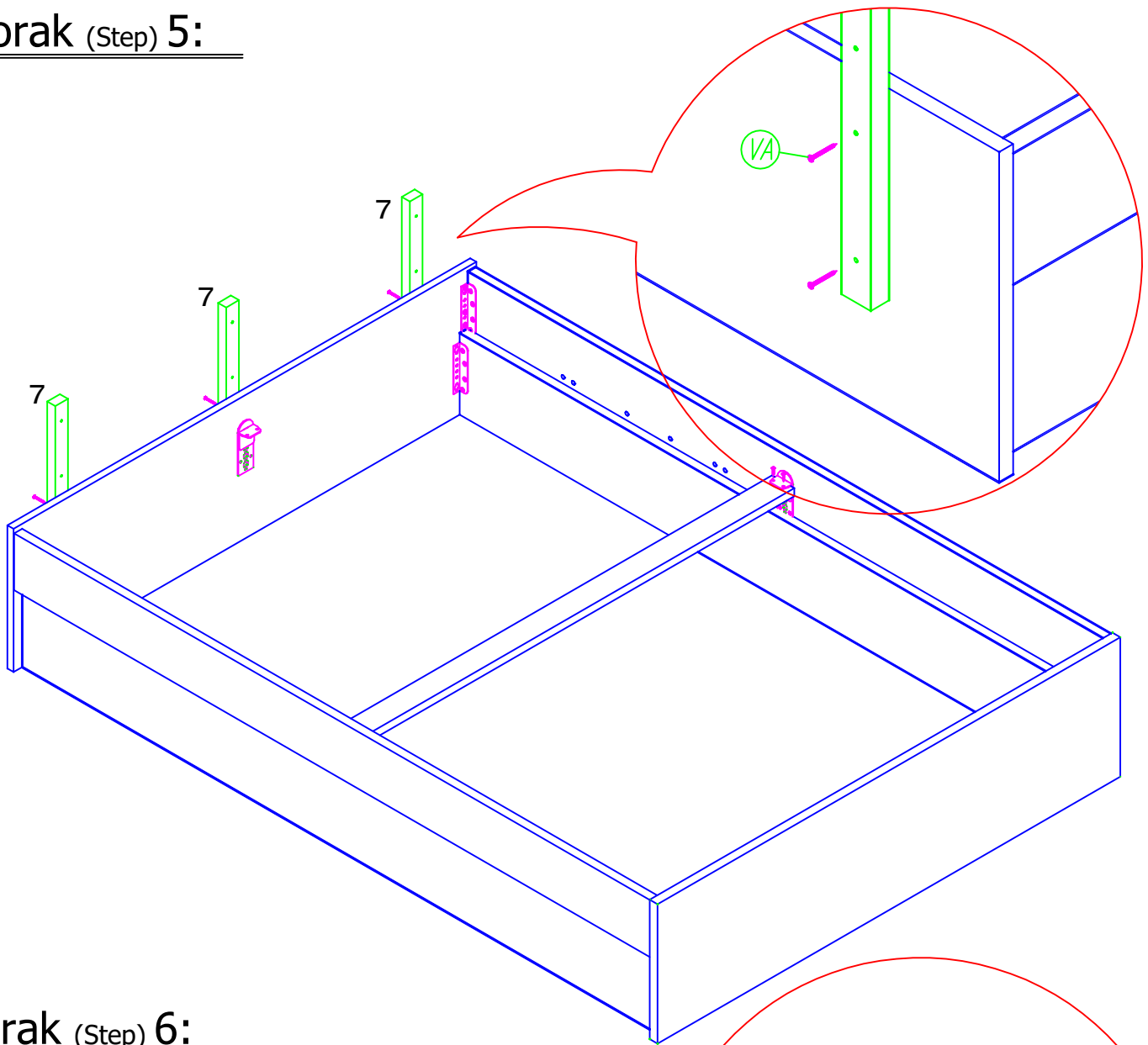

Korak (Step) 6:

